



INSTALLATION INSTRUCTIONS

Accessory
**AUTOMATIC DAY/NIGHT
MIRROR**

Application
2017 RIDGELINE

Publications No.
VERSION 1

Issue Date
JUN 2016

PARTS LIST

**Automatic Day/Night Mirror Attachment Kit
P/N 76410-SZA-A01**

Harness cover



Service Parts

Automatic Day/Night mirror



TOOLS AND SUPPLIES REQUIRED

Phillips screwdriver

10 mm Open end wrench

T20 TORX bit

Small flat-tip screwdriver

Shop towel

The following tool is available through the Honda Tool and Equipment Program. On the iN, click on: Service > Service Bay > Tool and Equipment Program, then enter the number under "Search". Or, call 888-424-6857.

- Trim Tool Set (T/N SOJATP2014)
- Plastic Trim Tool (T/N SILTRIMTL10)

Illustration of the Automatic Day/Night Mirror on the Vehicle

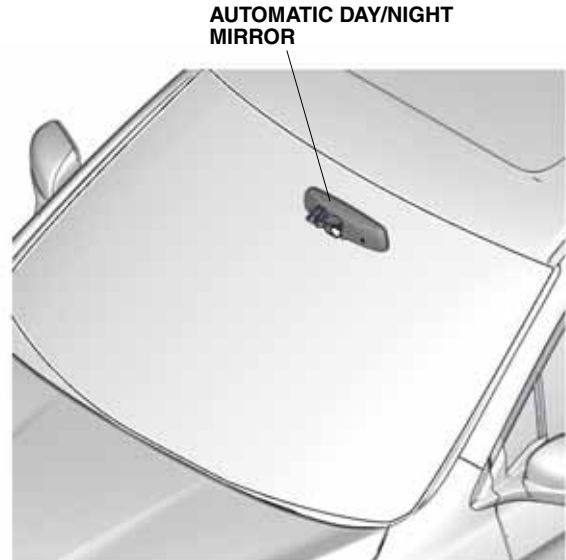

QDN2508AX

INSTALLATION

Customer Information: The information in this installation instruction is intended for use only by skilled technicians who have the proper tools, equipment, and training to correctly and safely add equipment to your vehicle. These procedures should not be attempted by “do-it-yourselfers.”

1. Wrap a shop towel around the hood latch.

HOOD LATCH
(Wrap with a shop towel.)

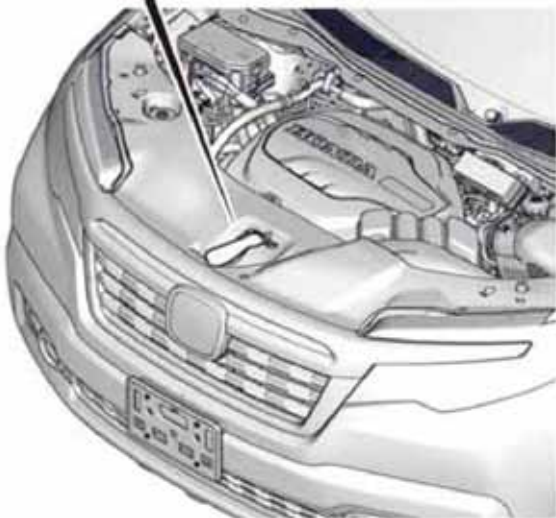
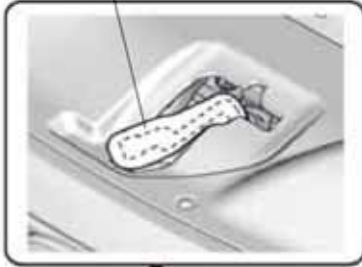

AE01403AB

- Remove the front bulkhead cover.

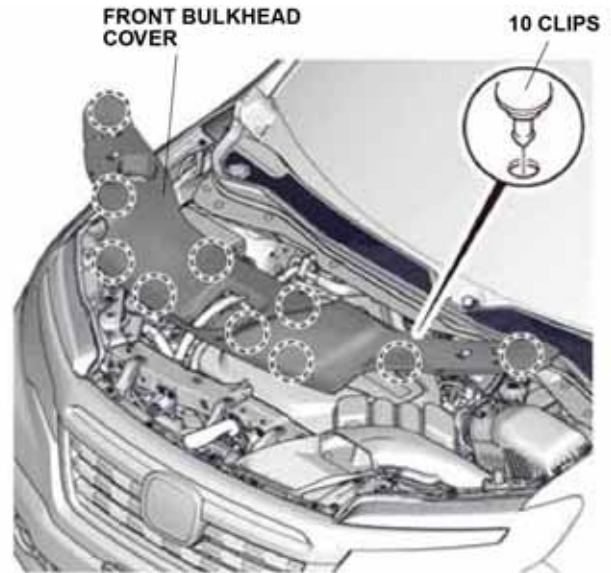

QE01403AB

- Remove the intake air tube.
- Disconnect the negative cable from the battery.

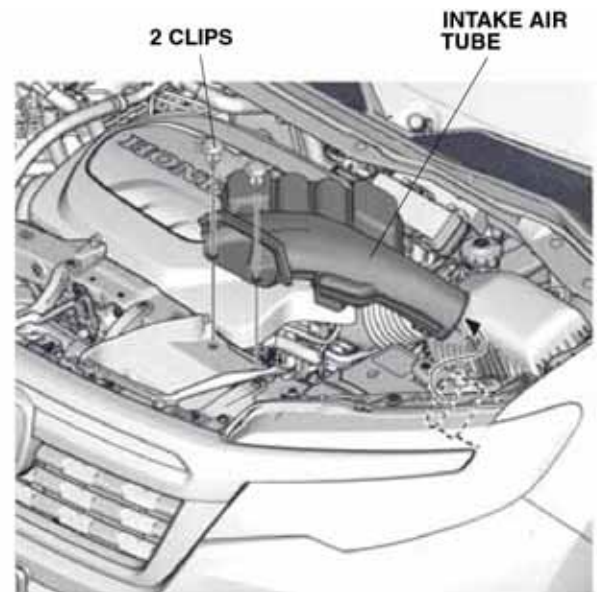

AE01403AB

2. Remove the roof console.
 - Using a small flat-tip screwdriver wrapped with a shop towel, pry out and remove the left and right lens.
 - Open the sunglass holder and remove the four screws.
 - Remove the roof console and unplug the vehicle connectors.

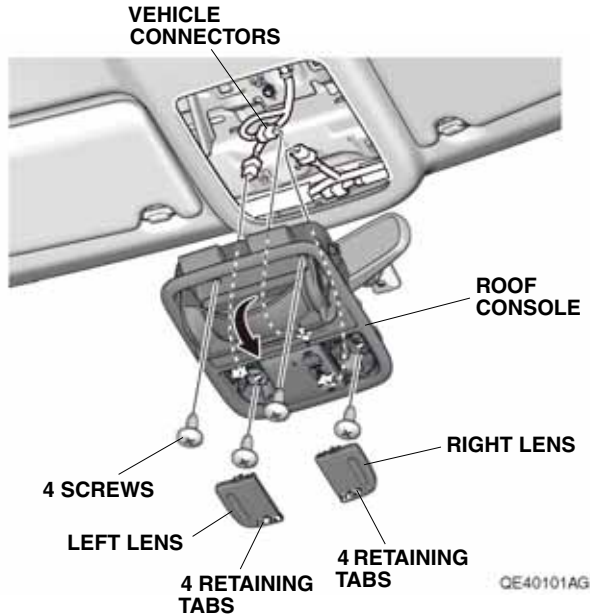

3. Loosen the TORX screw, and remove the rear view mirror.

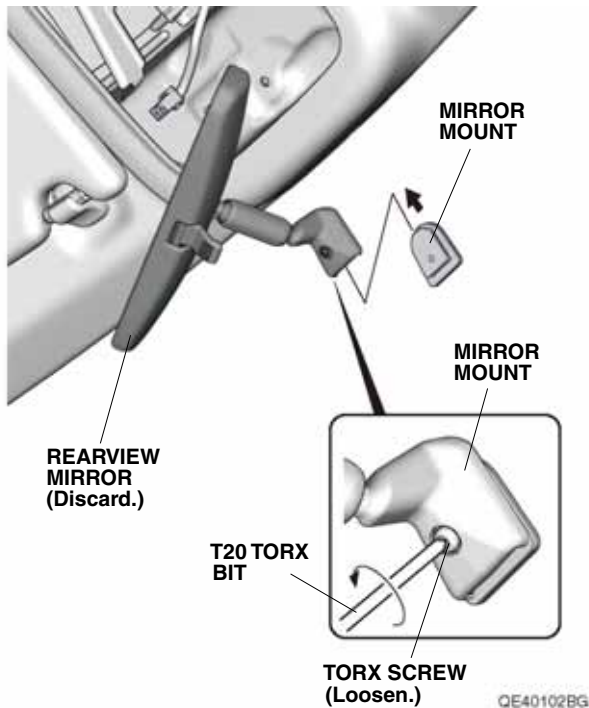

4. Install the automatic day/night mirror on the mirror mount as shown, and tighten the TORX screw.

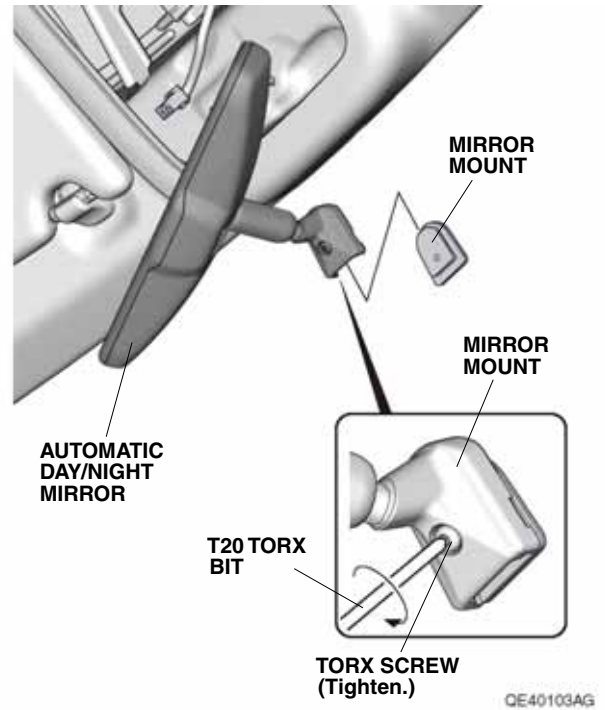

5. Remove the tape from the headliner, and release the vehicle 7-pin connector.

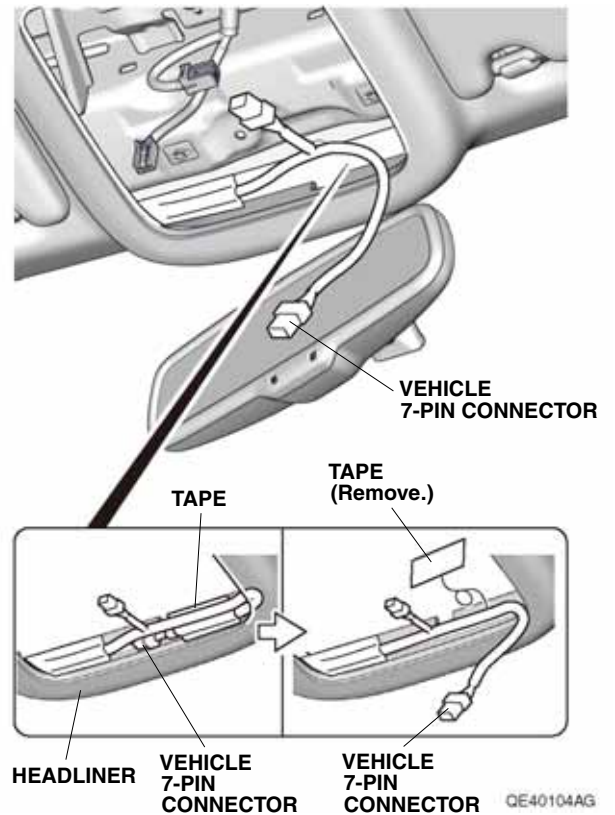

- Route the vehicle harness as shown, and plug the vehicle 7-pin connector into the automatic day/night mirror. Be careful not to crease the headliner.

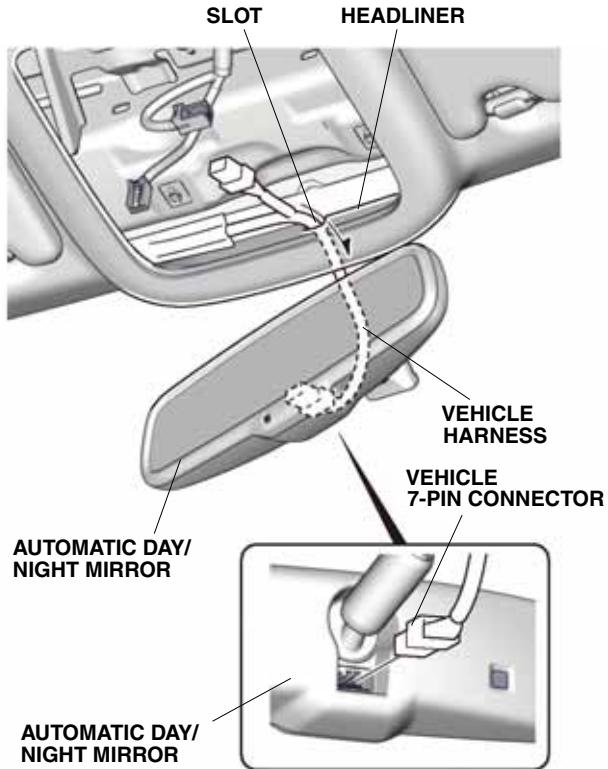

QE40105AG

- Secure the harness cover to the mirror mount. Slide the harness cover behind the headliner.

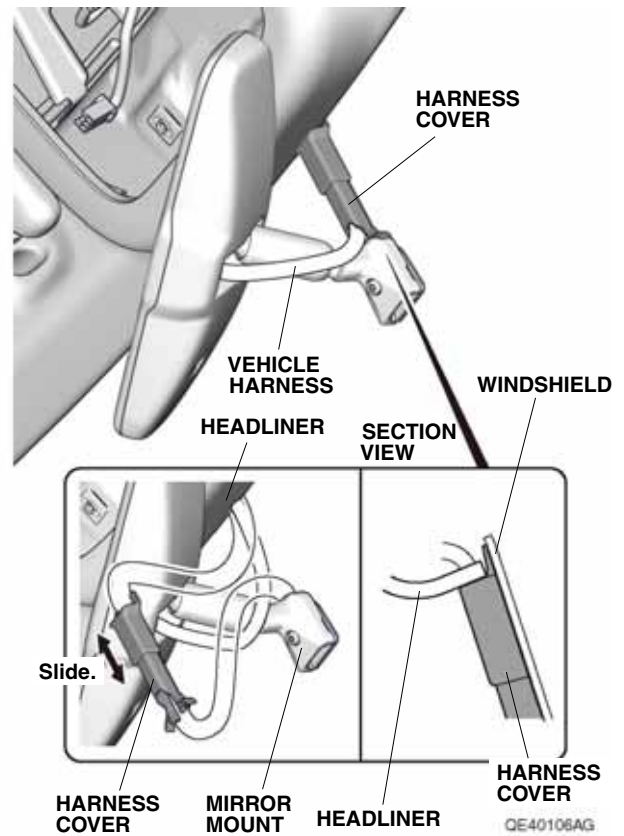

QE40105AG

- Check that all wire harnesses are routed properly and all connectors are plugged in.
- Install all removed parts except for the front bulkhead cover and the intake air tube.
- Connect the negative cable to the battery.
- Install the front bulkhead cover and the intake air tube.
- Press and hold the audio unit power button for two seconds to restore the audio and navi (if equipped) system functions.
- Set the clock on vehicle without navigation.

NOTE: Check the operation of the automatic day/night mirror according to the owner's manual.