



INSTALLATION INSTRUCTIONS

Accessory
SIDE UNDER SPOILERS
P/N 08F04-TBG-100

Application
2017 CIVIC
2-DOOR

Publications No.
VERSION 1
Issue Date
SEP 2016

PARTS LIST

Left spoiler



Right spoiler



22 Seals



TOOL AND SUPPLIES REQUIRED

Phillips screwdriver

Stubby Phillips screwdriver

The following tool is available through the Honda Tool and Equipment Program. On the iN, click on: Service > Service Bay > Tool and Equipment Program, then enter the number under "Search." Or, call 888-424-6857.

- Plastic Trim Tool (T/N SILTRIMTL10)

Illustration of the Side Under Spoilers on the Vehicle

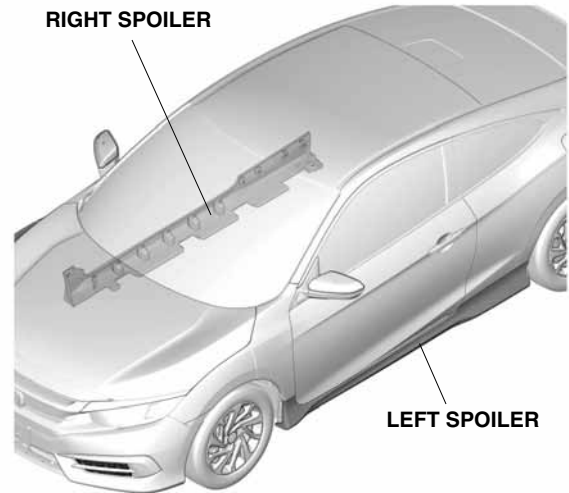

QE61901AH

INSTALLATION

Customer Information: The information in this installation instruction is intended for use only by skilled technicians who have the proper tools, equipment, and training to correctly and safely add equipment to your vehicle. These procedures should not be attempted by "do-it-yourselfers."

NOTE: Be careful not to damage the body paint finish.

Installing the Spoilers

1. Turn the steering wheel fully counterclockwise.

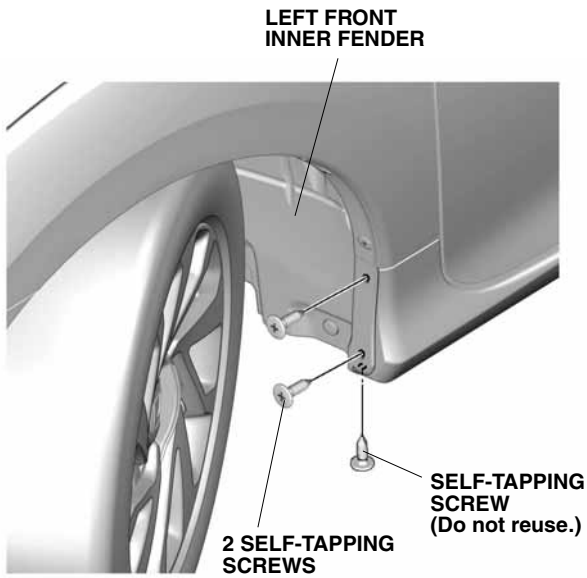

QE61902AH

2. Remove three self-tapping screws from the left front inner fender.
3. Remove two self-tapping screws from the left rear inner fender.

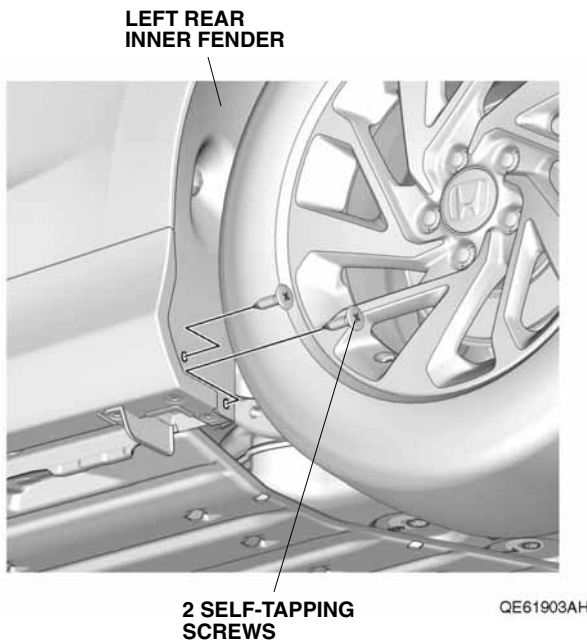

QE61903AH

4. Remove four clips from the left side sill trim.

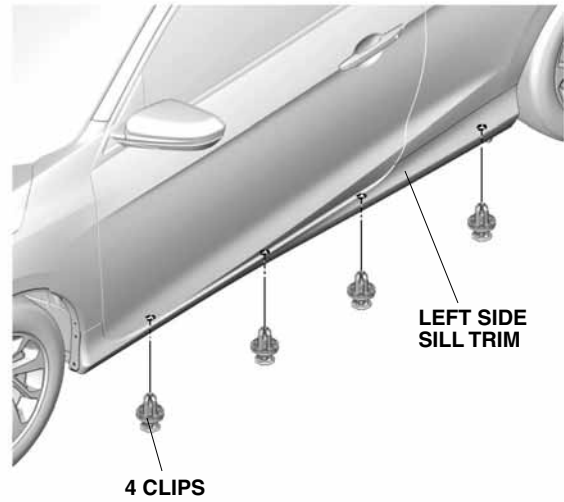

QE61904AH

5. Open the left door.

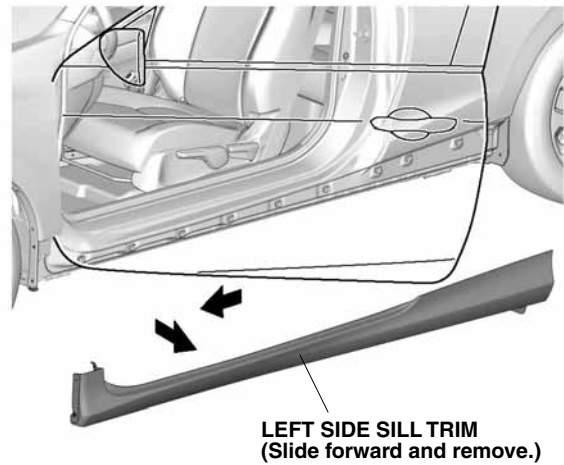

QE61905AH

6. Remove the left side sill trim.

7. Close the left door.

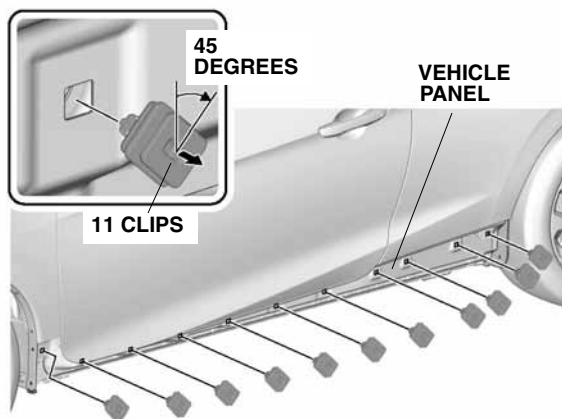

QE61906AH

8. Remove the 11 clips from vehicle panel.

9. Remove and replace 11 seals.

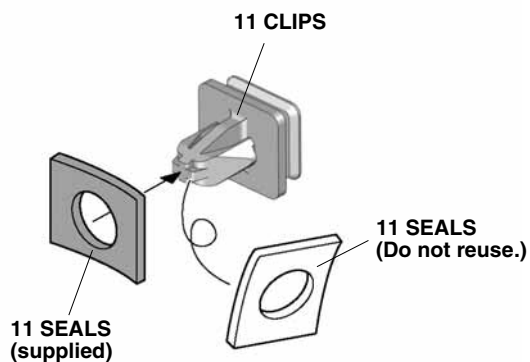

QE32425BH

10. Remove the three spring nuts from the left side sill trim.

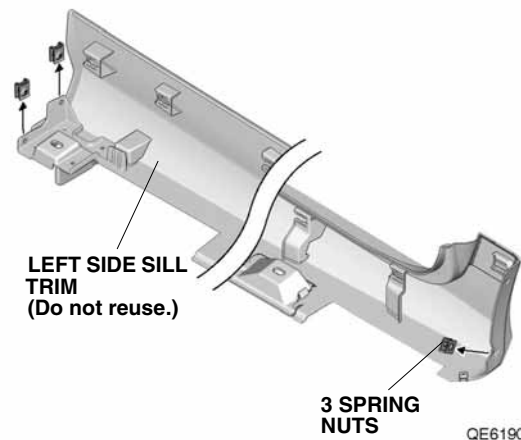

QE61907AH

11. Install the three spring nuts on the left spoiler.

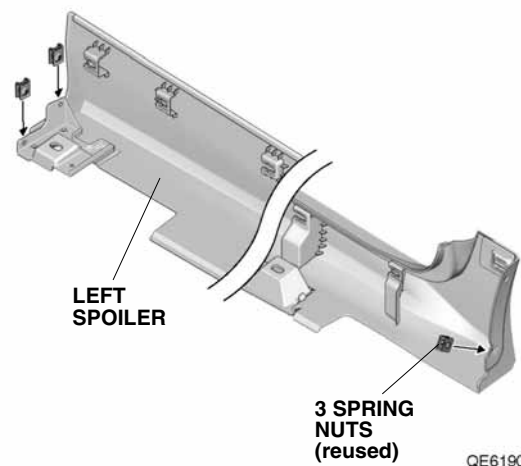

QE61908AH

12. Install the 11 clips on the left spoiler.

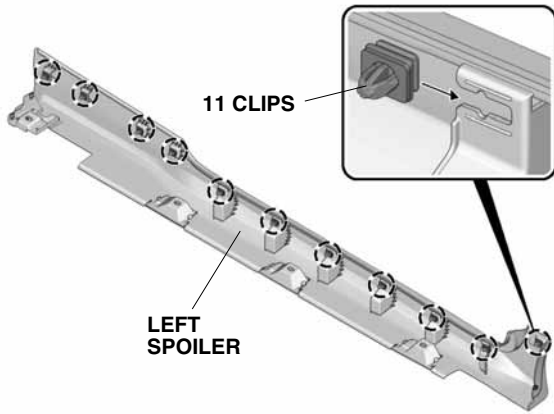

QE61909AH

13. Install the left spoiler on vehicle panel.

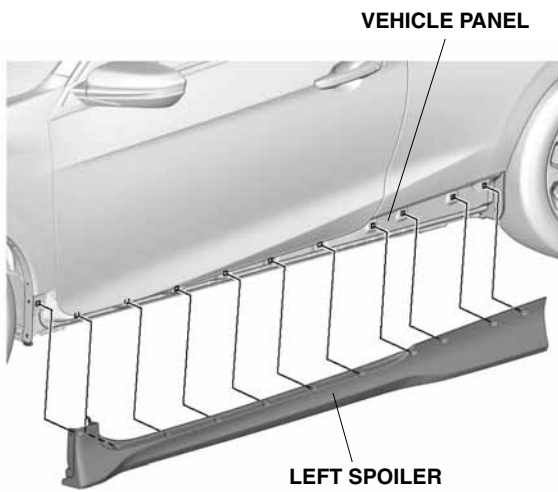

QE61910AH

14. Attach the left spoiler to the vehicle panel with four clips.

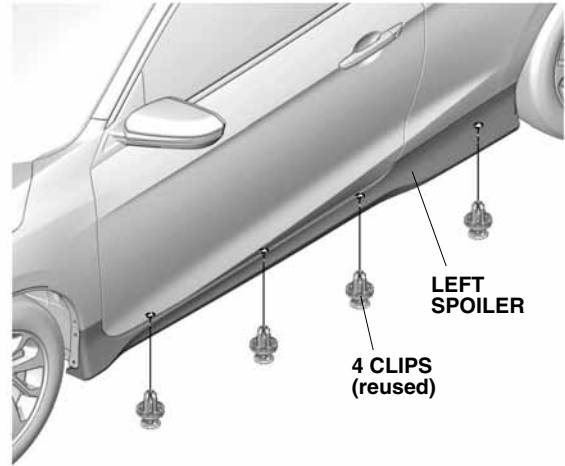

QE91911AH

15. Secure the front of the left spoiler with two self-tapping screws.

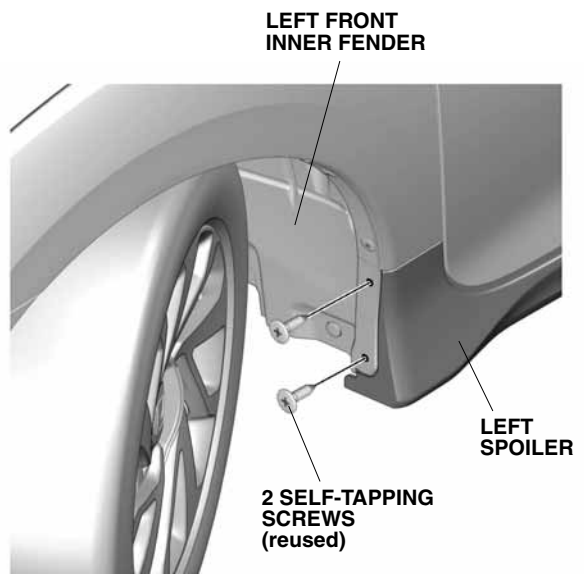

QE61912AH

16. Secure the back of the left spoiler with two self-tapping screws.

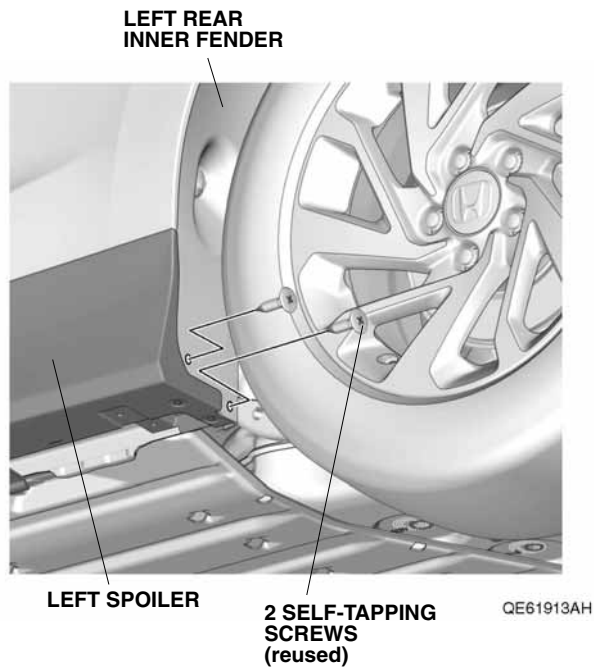

17. Turn the steering wheel fully clockwise, and repeat steps 2 through 16 on the right side of the vehicle.