



# INSTALLATION INSTRUCTIONS

Accessory  
**THIRD ROW SEAT COVERS**  
P/N 08P32-TK8-100A

Application  
**2016 ODYSSEY**

Publications No.  
**VERSION 1**  
Issue Date  
**JULY 2015**

Put this information in the glove box with the vehicle owner's manual.

## PARTS LIST

2 Third row headrest covers



Third row left seat back cover

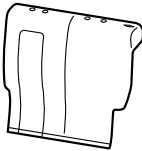

Third row left seat cushion cover

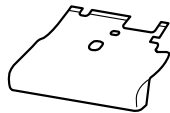

Third row center headrest cover



Third row right seat back cover



Third row right seat cushion cover

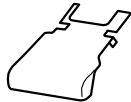

### Illustration of the Third Row Seat Covers in the Vehicle

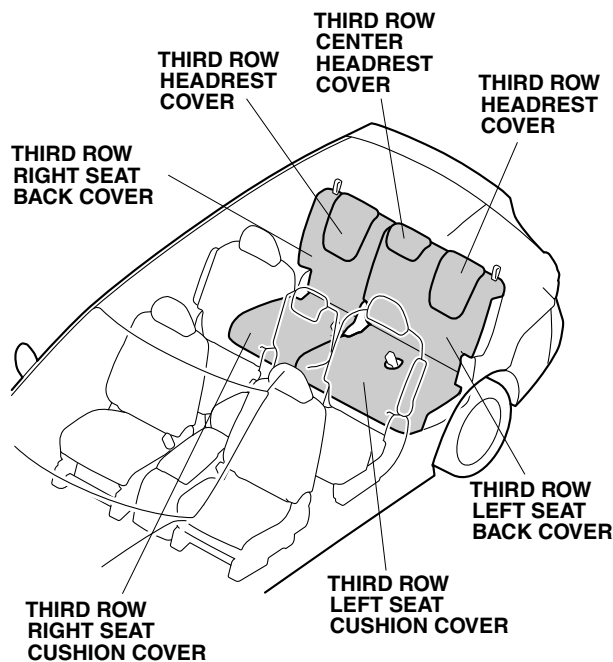

## INSTALLATION

**Customer Information:** The information in this installation instruction is intended for use only by skilled technicians who have the proper tools, equipment, and training to correctly and safely add equipment to your vehicle. These procedures should not be attempted by "do-it-yourselfers."

### NOTE:

- Be careful not to damage the seats while installing the rear seat covers.
- Do not install the third row seat covers on the front seats. Improperly covering the front seat can prevent your side airbags from inflating in a side impact.
- Identify each third row seat cover by the tags on the back.

1. Fold the third row seats forward halfway.

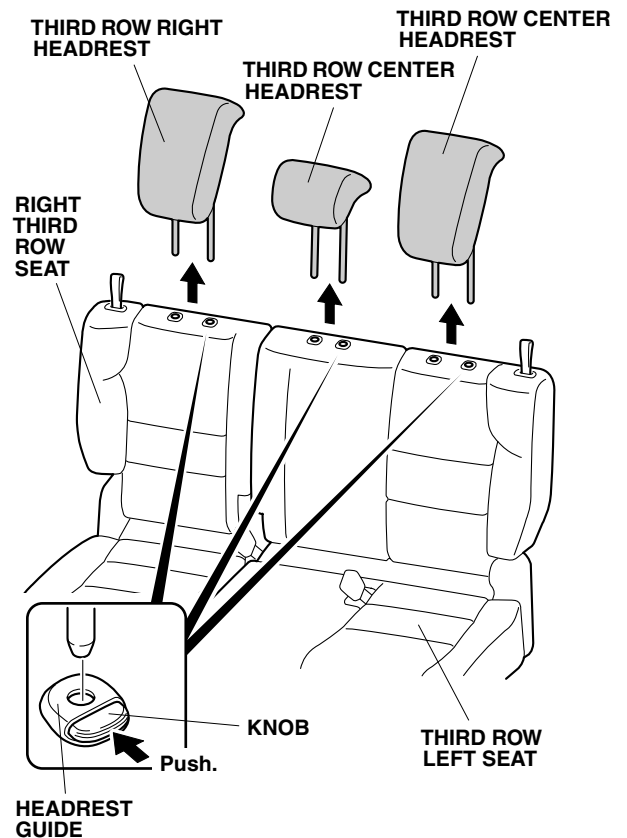

2. Push the knob and remove the headrests from the third row seats.

3. Install the two third row headrest covers and third row center headrest cover to the three headrests as shown.

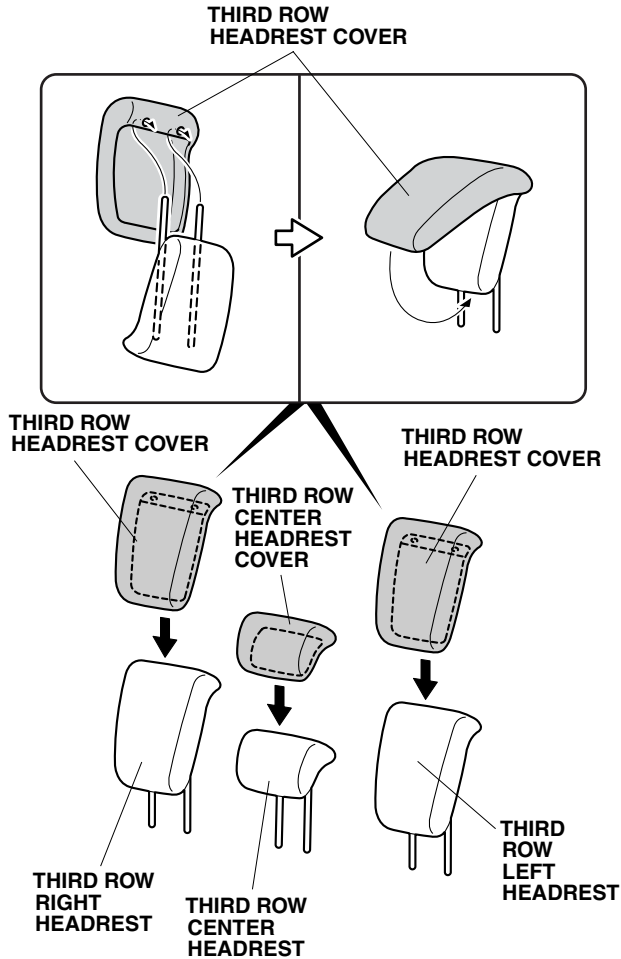

4. Install the third row left seat back cover to the third row left seat back with three hook-and-loop fasteners. Install in the order 1 → 2 → 3 → 4. NOTE: Make sure that the headrest guide on the third row left seat is not covered by the third row left seat back cover.

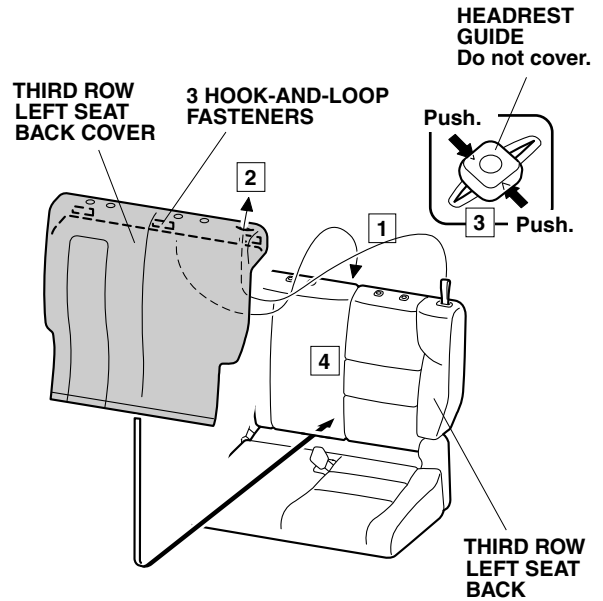

5. Fold down the third row left seat. Secure the third row left seat back cover to the third row left seat back with one hook-and-loop fastener. Return the third row left seat to the upright position.

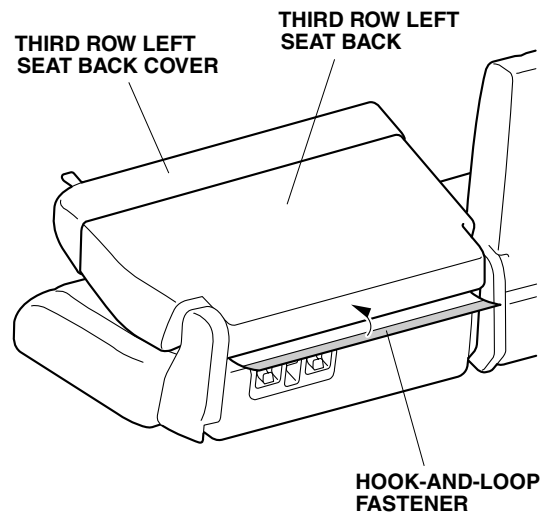

6. Install the third row left seat cushion cover to the third row left seat cushion in the order **1** → **2** → **3**.

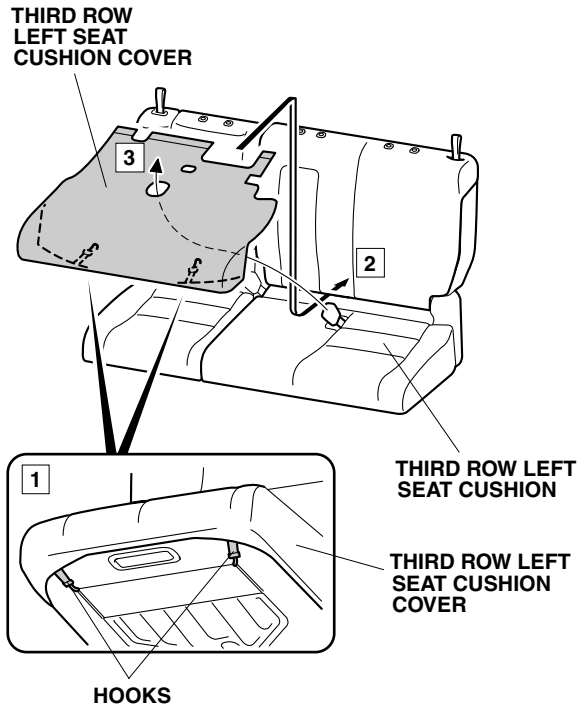

7. Secure the third row left seat cushion cover to the third row left seat cushion with the two hook-and-loop fasteners.

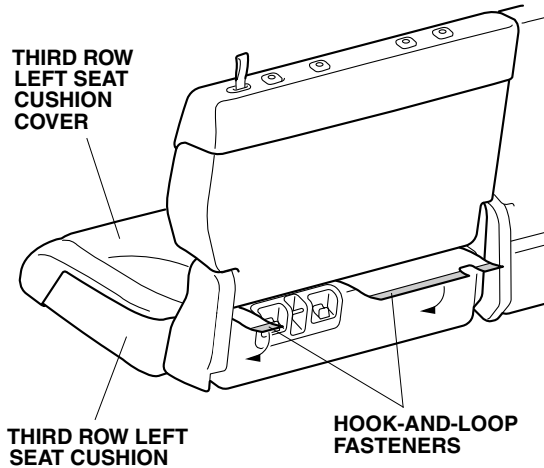

8. Install the third row right seat back cover to the third row right seat back with the two hook-and-loop fasteners. Install in the order **1** → **2** → **3** → **4**. NOTE: Make sure that headrest guide on the third row right seat is not covered by the third row right seat back cover.

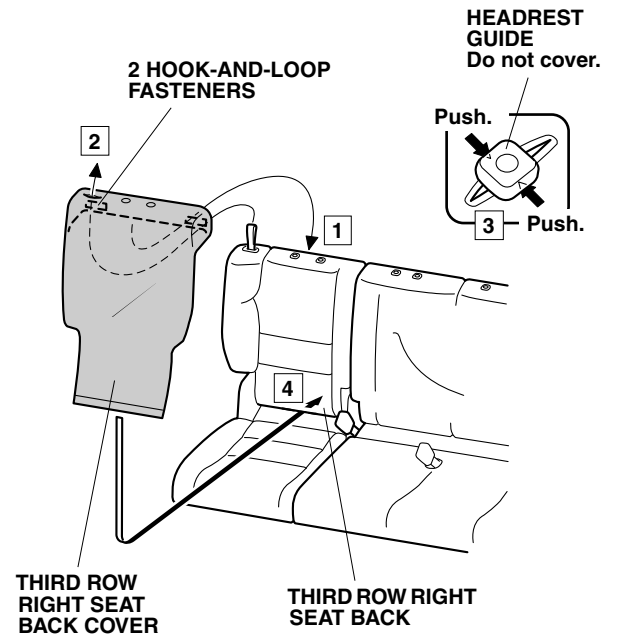

9. Fold down the third row right seat. Secure the third row right seat back cover to the third row right seat back with one hook-and-loop fastener. Return the third row right seat to the upright position.

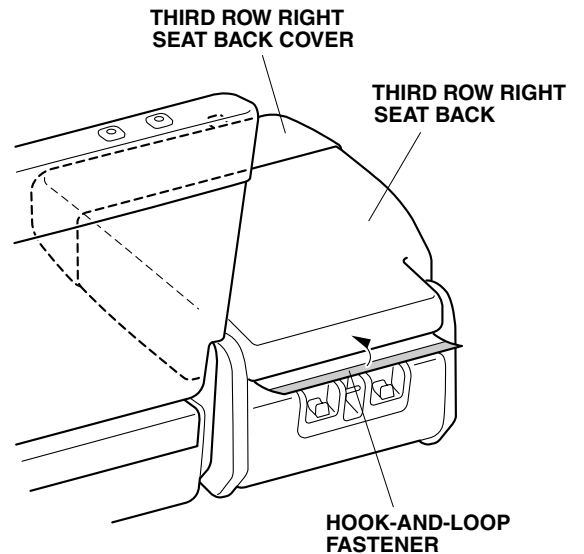

10. Install the third row right seat cushion cover to the third row right seat cushion in the order **1** → **2** → **3**.

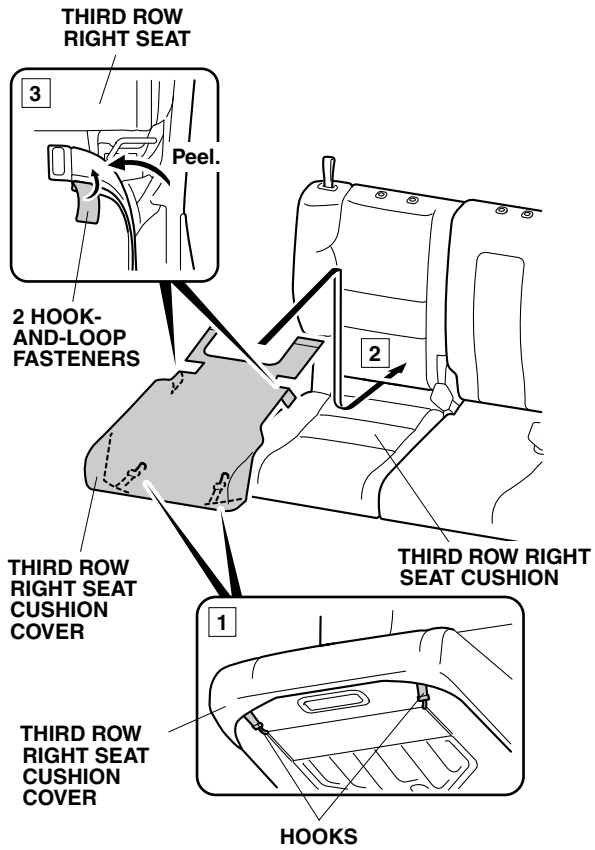

11. Secure the third row right seat cushion cover to the third row right seat cushion with the two hook-and-loop fasteners.

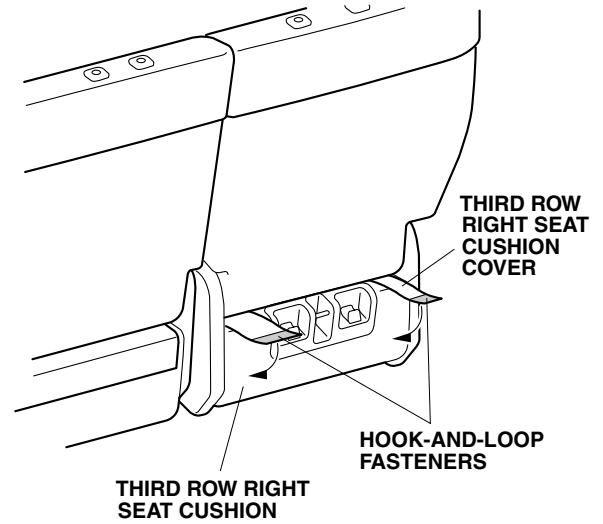

12. Reinstall each headrest.