



# INSTALLATION INSTRUCTIONS

Accessory  
**B-PILLAR DECORATIONS**  
P/N 08F34-SZT-100B

Application  
**2016 CR-Z**

Publications No.  
**VERSION 1**

Issue Date  
**OCT 2015**

## PARTS LIST

Left B-pillar decoration

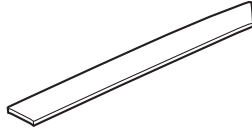

Right B-pillar decoration

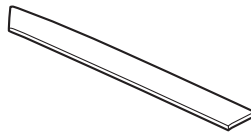

2 Alcohol swabs

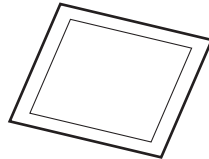

## TOOL AND SUPPLIES REQUIRED

Ruler

Masking tape

## Illustration of the B-Pillar Decorations on the Vehicle

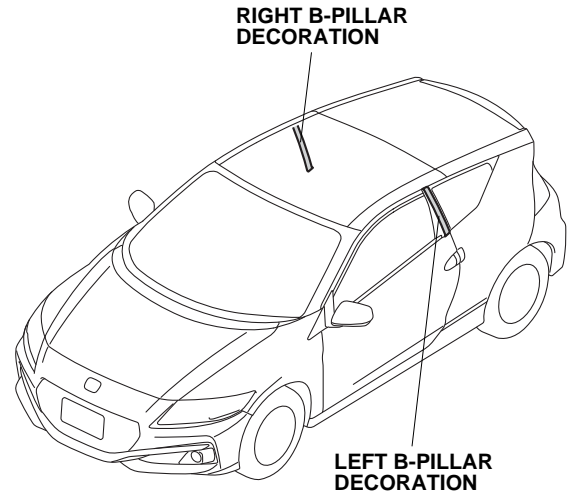

QE31723AG

## INSTALLATION

**Customer Information:** The information in this installation instruction is intended for use only by skilled technicians who have the proper tools, equipment, and training to correctly and safely add equipment to your vehicle. These procedures should not be attempted by “do-it-yourselfers.”

### NOTE:

- Do not damage the paint finish.
- This kit should be installed only if the ambient air temperature is 15° C (60° F) or above.
- To allow the adhesive to cure, do not wash the vehicle for 24 hours. Make sure your customer is aware of this.

- Using one alcohol swab, thoroughly clean the area where the left B-pillar decoration will attach.

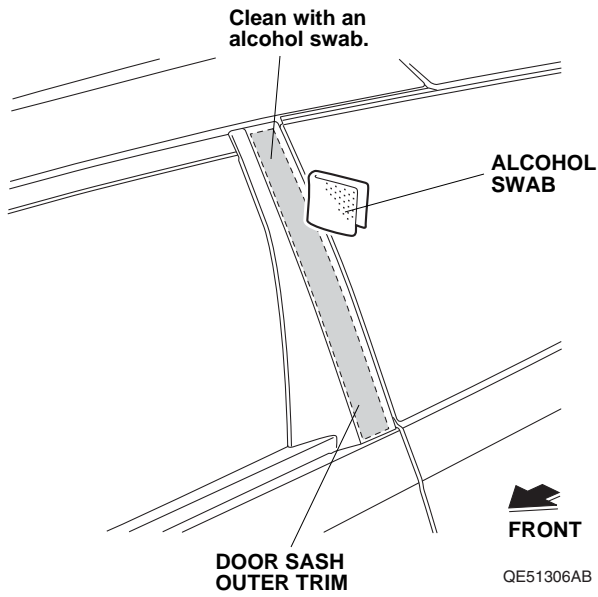

- Apply strips of masking tape to the end of the adhesive backings as shown. Peel back the adhesive backings partway and temporarily attach them to the front surface of the left B-pillar decoration. Remove the remaining adhesive backings.

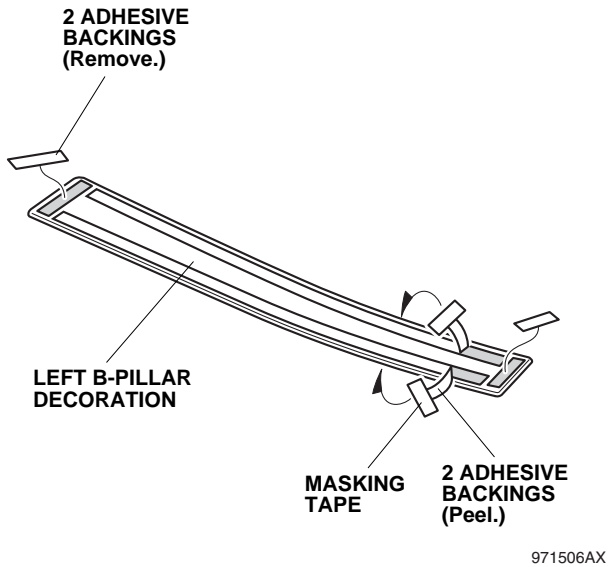

- Line up the left B-pillar decoration to the door sash outer trim as shown.

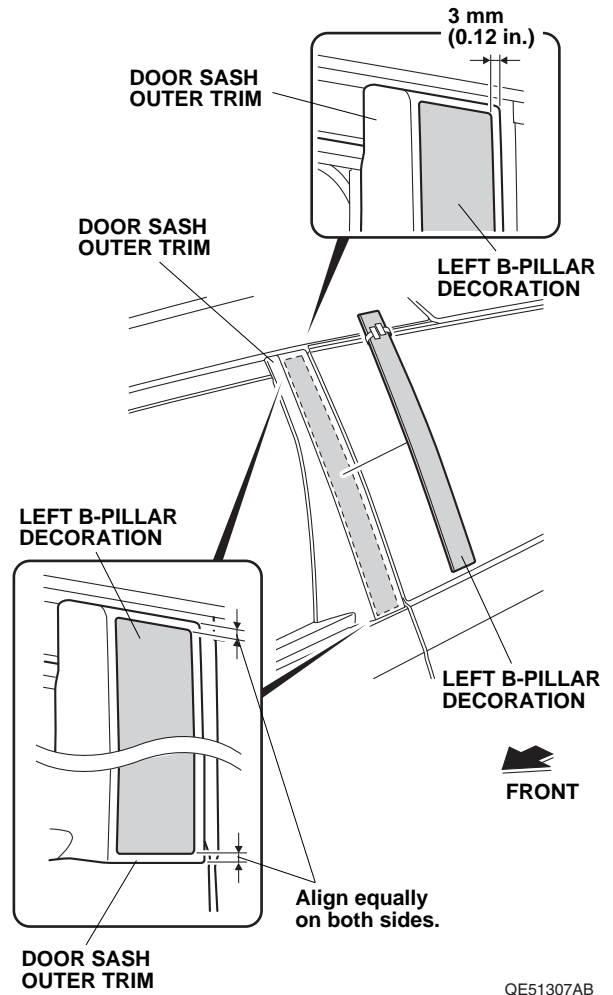

4. While applying light pressure against the left B-pillar decoration, carefully remove the taped adhesive backings.

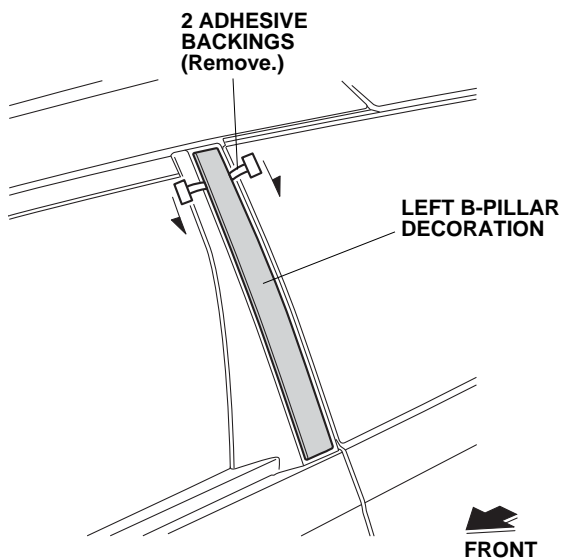

9N0403AX

5. With the palm of your hand, firmly press the left B-pillar decoration onto the door sash outer trim.
6. Repeat steps 1 through 5 on the right side.