

**PARTS LIST**

Hood air deflector

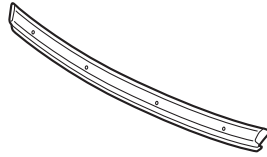

2 Brackets A

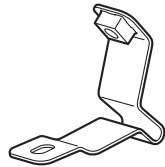

Bracket B

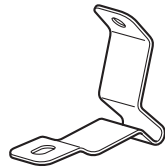

Bracket C



4 Washers



2 Alcohol swabs

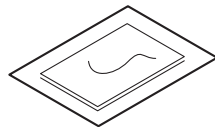

2 Clips



2 Screws



3 Truss screws



4 Protection films



Advice label

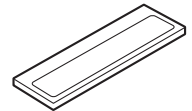

3 Grommet nuts



**TOOLS AND SUPPLIES REQUIRED**

Phillips screwdriver

Masking tape

Ruler

***Illustration of the Hood Air Deflector Installed on the Vehicle***

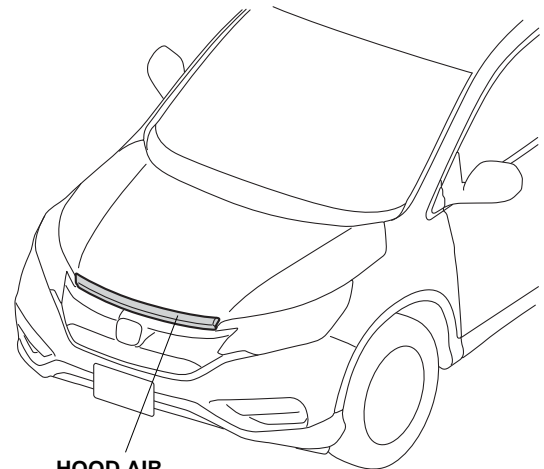

**HOOD AIR  
DEFLECTOR**

QD61001AA

## INSTALLATION

**Customer Information:** The information in this installation instruction is intended for use only by skilled technicians who have the proper tools, equipment, and training to correctly and safely add equipment to your vehicle. These procedures should not be attempted by “do-it-yourselfers.”

### NOTE:

- The hood air deflector can not be installed on vehicle equipped with a nose mask.
- Be careful not to damage the body paint finish.

### Installing the Hood Air Deflector

1. Open the hood. Locate the three square holes on the inside of the hood. Push one grommet nut into each square hole in the hood.

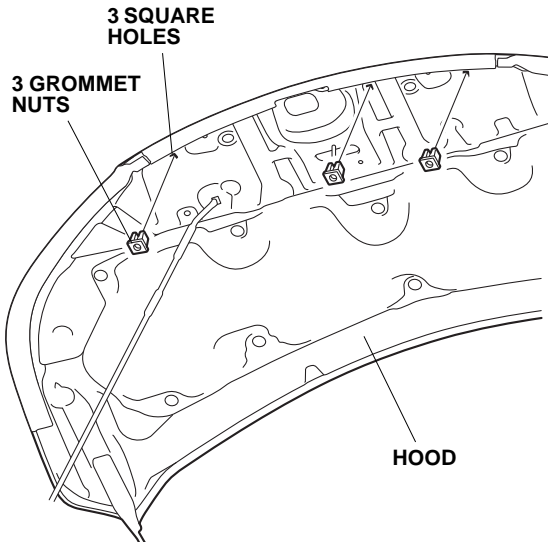

QD61002AA

2. Fold back the rubber seal from inside edge of the hood. Using an alcohol swab, clean the areas where the protection films will attach.

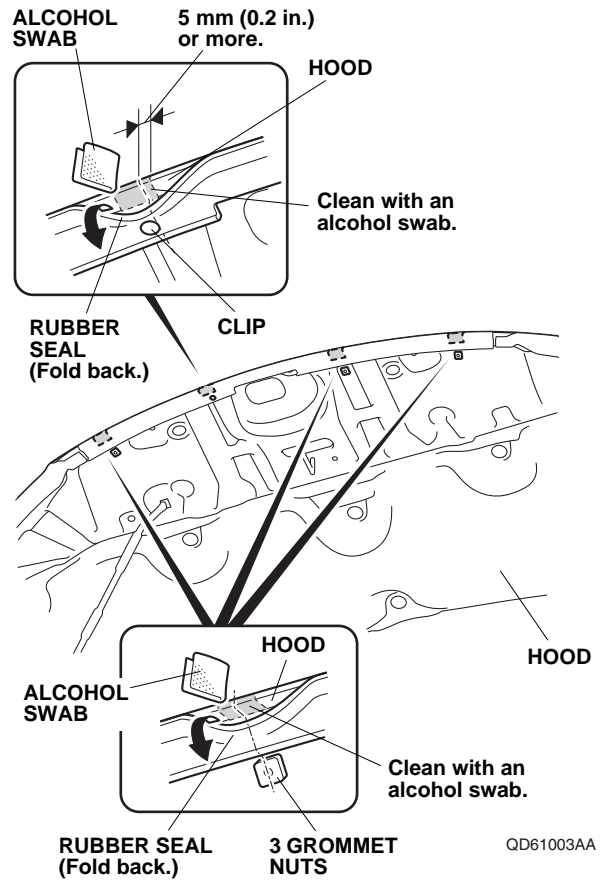

- Remove the adhesive backings from the protection films, and attach them to the front of the hood area where the two brackets A, one bracket B and one bracket C will mount.

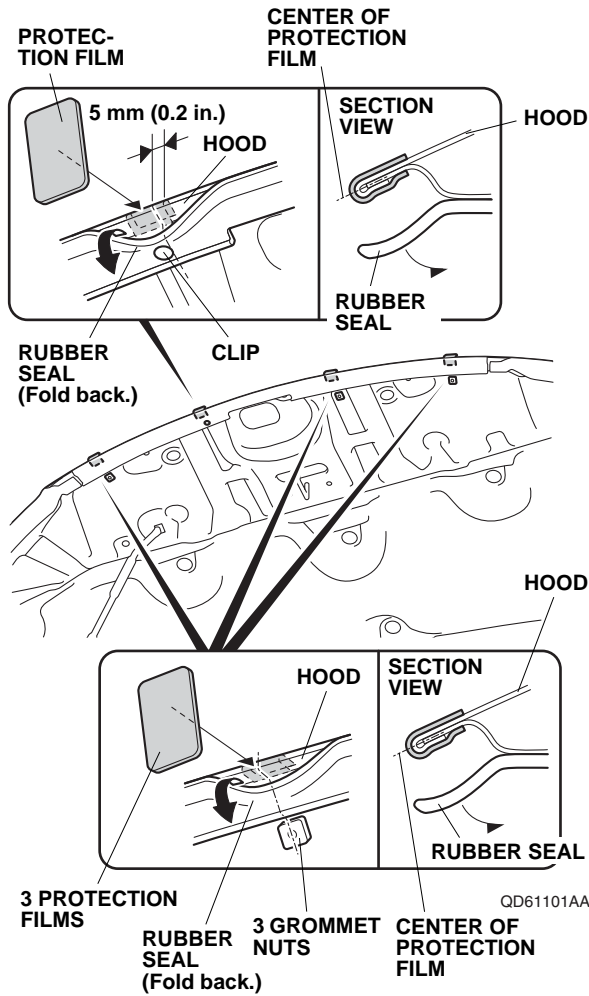

- Slide two brackets A and one bracket B over the lip of the hood under the rubber seal. Loosely install two brackets A and one bracket B to the grommet nuts on the hood with three truss screws.

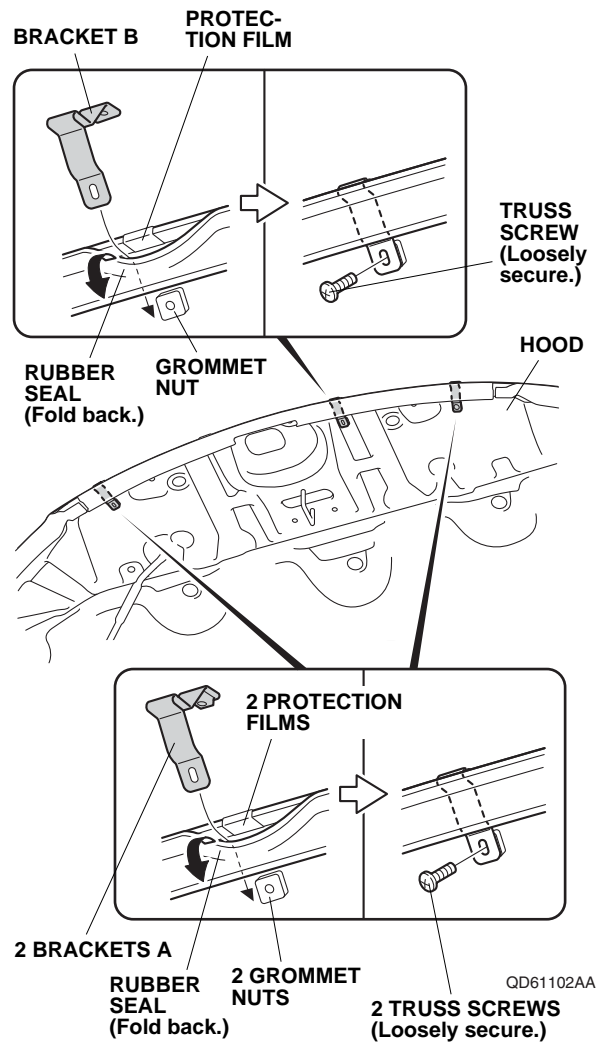

- Slide one bracket C over the lip of the hood under the rubber seal, and align the bracket C with the clip on the rubber seal. Secure the bracket C to the hood with masking tape as shown.

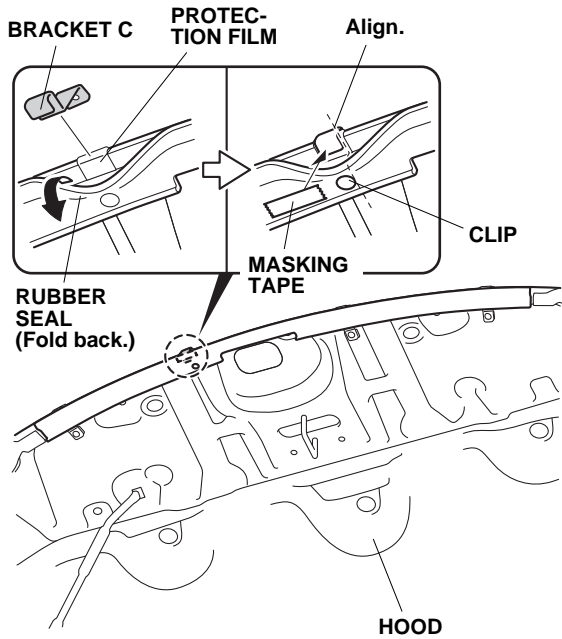

QD61201AA

- Gently close the hood. Position the hood air deflector on the hood by inserting the rubber molding between the front tip of the hood and the rubber seal as shown.

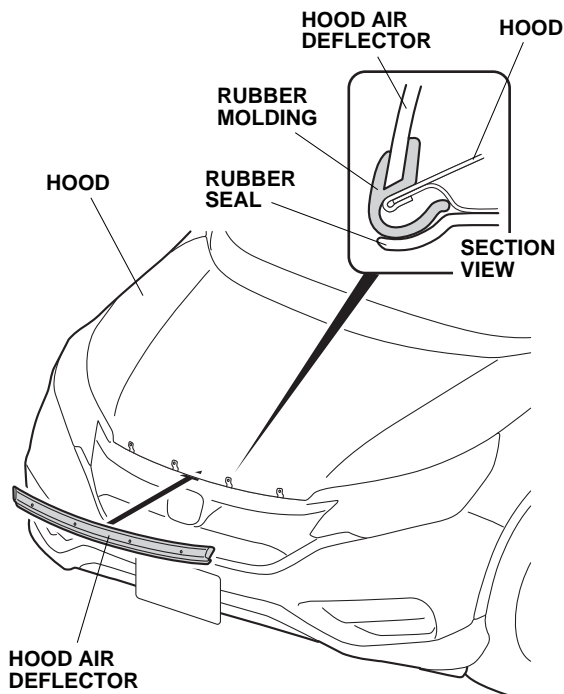

QD61202AA

- Align the holes in the hood air deflector with the holes in the four brackets. Secure the hood air deflector to the brackets with two screws, four washers and two clips. Tighten the screws securely.

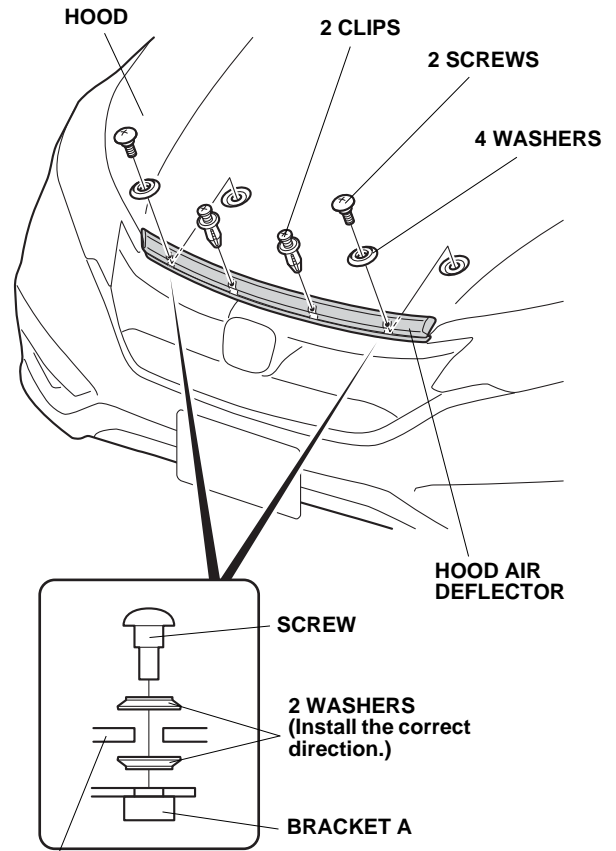

HOOD AIR DEFLECTOR

QE22101AA

- Open the hood. Tighten three truss screws loosely installed in step 4. Remove the masking tape attached in step 5.

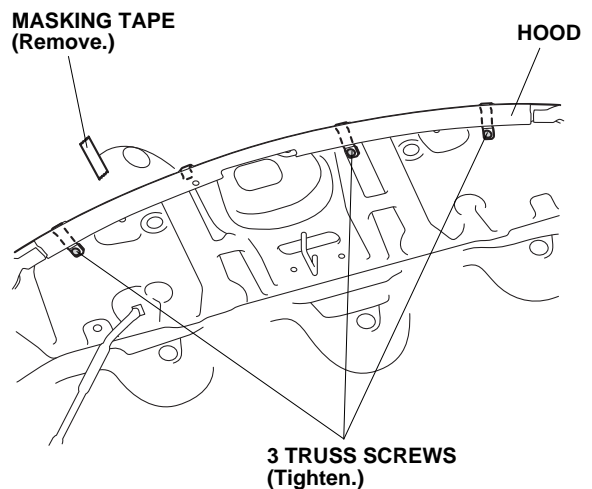

QD61204AA

9. Using an alcohol swab, clean the inside the hood where the advice label will attach.

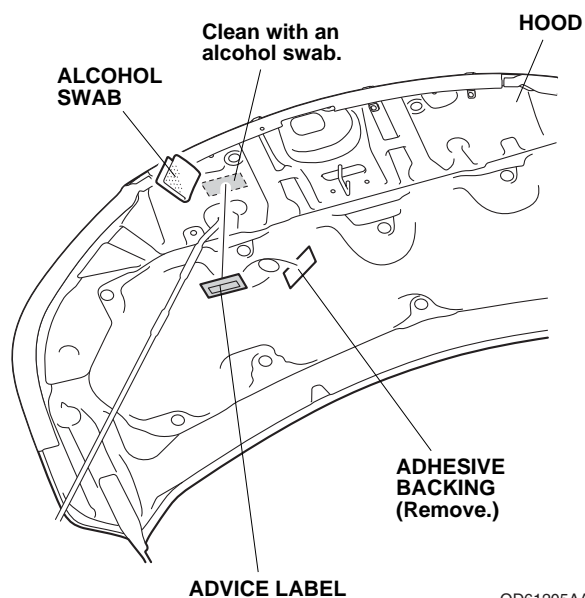

QD61205AA

10. Remove the adhesive backing from the advice label, and attach the advice label to the hood as shown.  
NOTE: Do not attach the advice label over the other vehicle caution labels.

#### CARE OF THE HOOD AIR DEFLECTOR

- To avoid damaging the surface, never use ammonia-based cleaners or solvents to clean the hood air deflector.
- Clean with a solution of mild dishwashing soap and water using a soft cloth or chamois.
- To remove fine scratches and restore the original luster, use Meguiar's Mirror Glaze plastic cleaner and polish or an equivalent high-quality plastic cleaner.