



# INSTALLATION INSTRUCTIONS

Accessory  
REAR HFP EMBLEM  
P/N 08F20-TS9-100

Application  
2016 ACCORD  
2-DOOR

Publications No.  
**VERSION 1**  
Issue Date  
**AUG 2015**

## PARTS LIST

HFP emblem

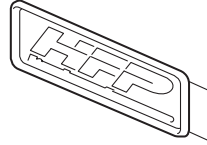

## TOOLS AND SUPPLIES REQUIRED

- Shop towel
- Isopropyl alcohol
- Masking tape
- Ruler

### Illustration of the Rear HFP Emblem on the Vehicle

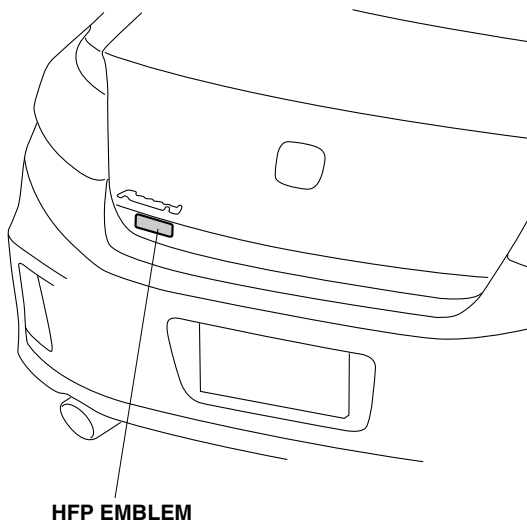

B32701A

## INSTALLATION

**Customer Information:** The information in this installation instruction is intended for use only by skilled technicians who have the proper tools, equipment, and training to correctly and safely add equipment to your vehicle. These procedures should not be attempted by “do-it-yourselfers.”

### NOTE:

- Be careful not to damage the vehicle body paint finish.
- This kit should be installed only if the ambient air temperature is 15°C (60°F) or above.
- To allow the adhesive to cure, do not wash the vehicle for 24 hours. Please advise the customer.

### Installing the HFP Emblem

1. Attach pieces of masking tape to the trunk lid at the measurements shown.

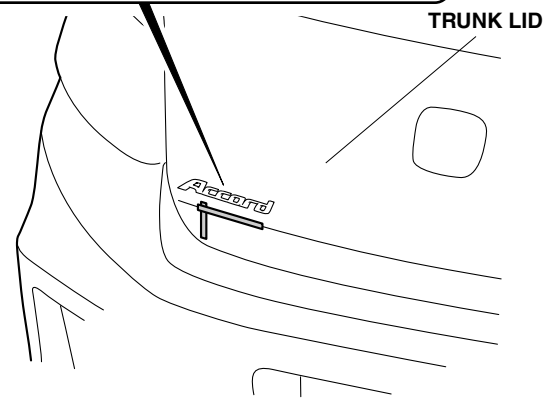
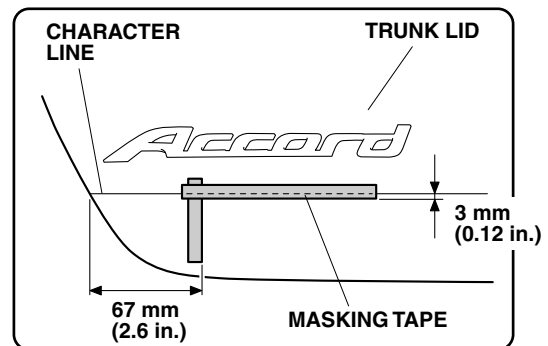

B32702A

2. Using isopropyl alcohol on a shop towel, thoroughly clean the trunk lid where the HFP emblem will attach.

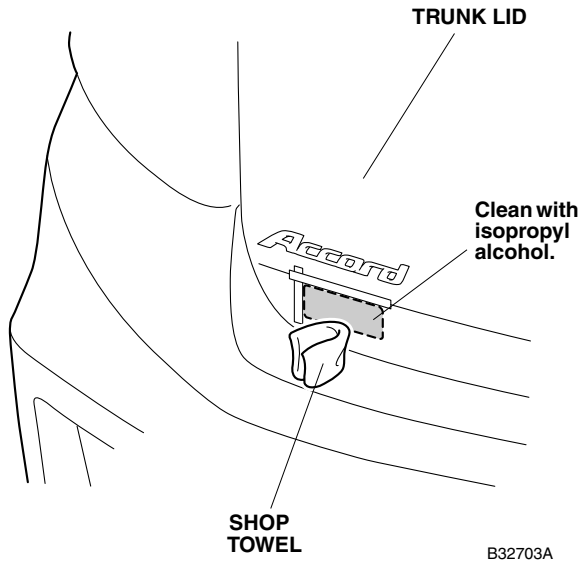

3. Peel back the adhesive backing, and tape it to the front surface of the HFP emblem as shown.

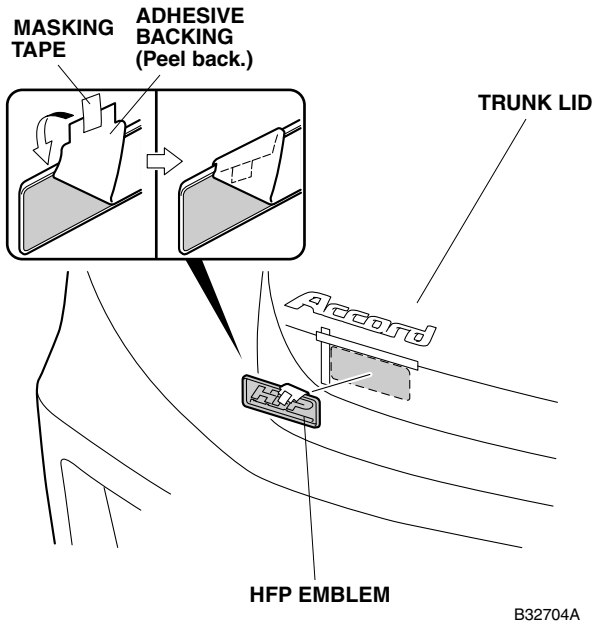

4. Attach the HFP emblem to the trunk lid.

5. Gently hold the HFP emblem against the trunk lid and remove the adhesive backing.

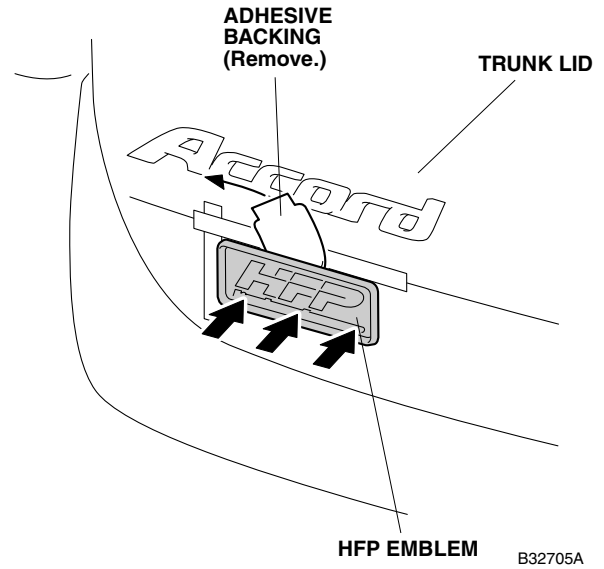

6. Using the palm of your hand, firmly press the HFP emblem against the trunk lid for 30 seconds.
7. Remove the masking tape.