



INSTALLATION INSTRUCTIONS

Accessory
CARGO COVER

Application
2014 PILOT

Publications No.
All 50244

Issue Date
AUG 2013

Put this information in the glove box with the vehicle owner's manual.

PARTS LIST

Cargo Cover (without power tailgate)
P/N 08U35-SZA-1X0

Cargo cover

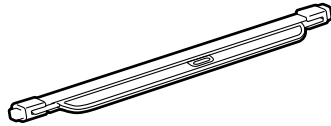

Cargo Cover (with power tailgate)
P/N 08U35-SZA-1X0A

Cargo cover

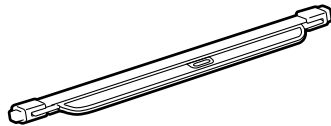

TOOLS AND SUPPLIES REQUIRED

Small flat-tip screwdriver

INSTALLATION

NOTE: This cargo cover cannot be installed in vehicles with a cargo liner.

Installing the Cargo Cover

1. Using a small flat-tip screwdriver, push and release the seat belt lower hooks from the third row seat. Insert the seat belt lower hooks into the side slots.

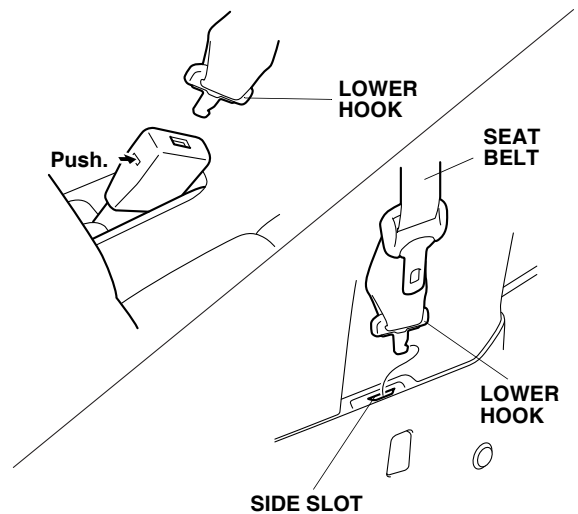

2. Fold down the third row seat.

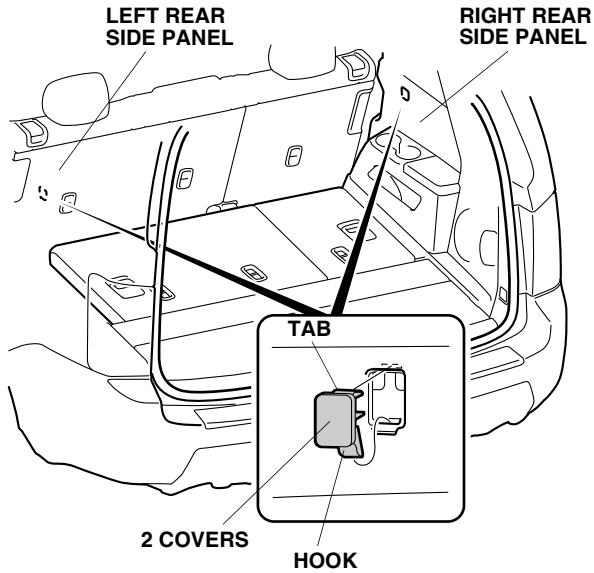

3. Using a small flat-tip screwdriver, remove the covers from the right and left rear side panels by releasing the tab and hook. Save the covers in the glove box so they can be reinstalled when the cargo cover is removed.
4. Install the cargo cover into the recess in the left rear side panel in the direction shown, then compress the cargo cover, and install it in the right rear side panel.

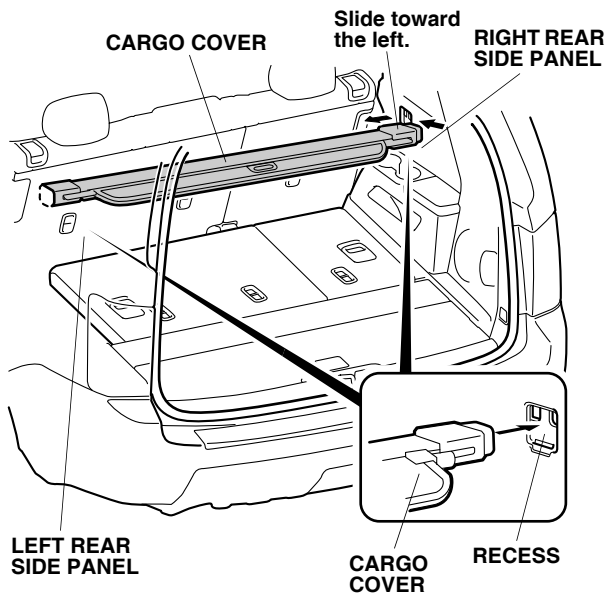

5. Pull out the cargo cover, and attach the right and left rods on the cargo cover to the right and left rear side panel.

