



INSTALLATION INSTRUCTIONS

Accessory
ALL-SEASON FLOOR MATS

Application
2014 PILOT

Publications No.
All 50236
Issue Date
AUG 2013

Put this information in the glove box with the vehicle owner's manual.

PARTS LIST

All-Season floor Mat Set
P/N 08P13-SZA-110

Driver's side front floor mat

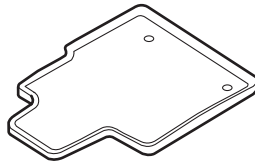

Passenger's side front floor mat

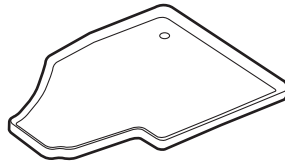

Second row floor mat

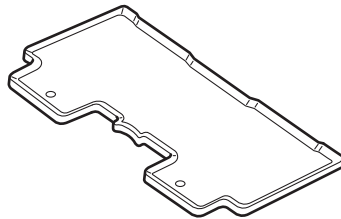

Third row floor mat

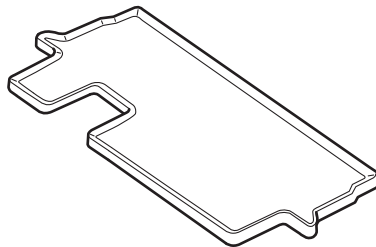

INSTALLATION

NOTE:

- Before installing, identify each floor mat.
- Remove the standard floor mats before installing these floor mats.
- Do not put any additional mats on top of the anchored mat. An additional mat may slide forward and possibly interfere with the pedals.

Installing the All-Season Floor Mats

1. Install the driver's side front floor mat by placing the two mat grommets over the two anchors on the floor carpet.

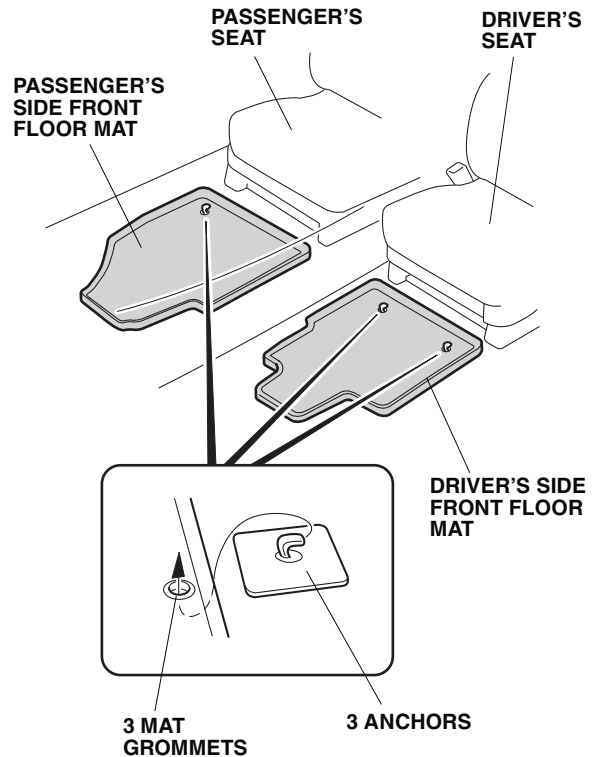

2. Install the passenger's side front floor mat by placing the mat grommet over the anchor on the floor carpet.

3. Install the second row floor mat by placing the two mat grommets over the two anchors on the floor carpet.

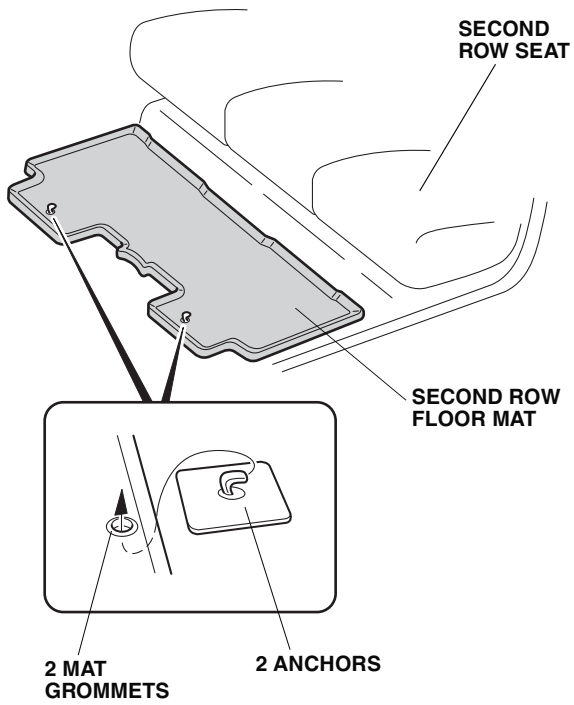

4. Install the third row floor mat on the floor carpet.

