



# INSTALLATION INSTRUCTIONS

Accessory  
**ADVANCED CARGO NET**  
P/N 08L96-SZA-100A

Application  
**2014 PILOT**

Publications No.  
**All 50235**  
Issue Date  
**AUG 2013**

## PARTS LIST

Advanced cargo net

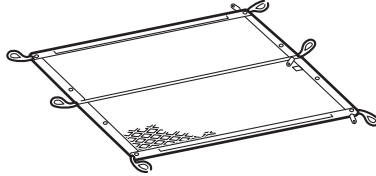

2 Anchors A (Large)



4 Anchors B (Small)



6 Self-tapping screws



4 Snaps

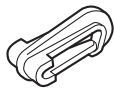

Accessory User's Information Manual

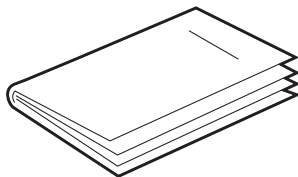

## TOOLS AND SUPPLIES REQUIRED

- Drill
- 3 mm, 5 mm, and 10.5 mm Drill bits
- Masking tape
- Tape
- Felt-tip pen
- Scale
- Small flat-tip screwdriver
- Eye protection (face shield, safety goggles, etc.)

## INSTALLATION

**Customer Information:** The information in this installation instruction is intended for use only by skilled technicians who have the proper tools, equipment, and training to correctly and safely add equipment to your vehicle. These procedures should not be attempted by "do-it-yourselfers."

### NOTE:

This advanced cargo net cannot be installed with the cargo liner or interior bicycle attachment.

### Installing the Hooks

- Using a small flat-tip screwdriver, push and release the seat belt lower hook from each third row seat. Insert the seat belt lower hooks into the side slots.

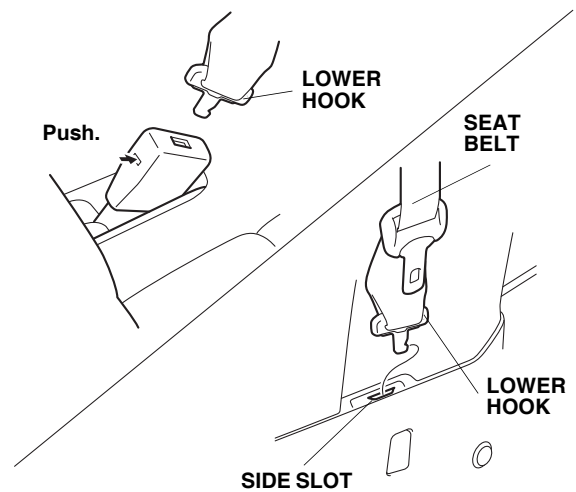

2. Fold down the third row seats.

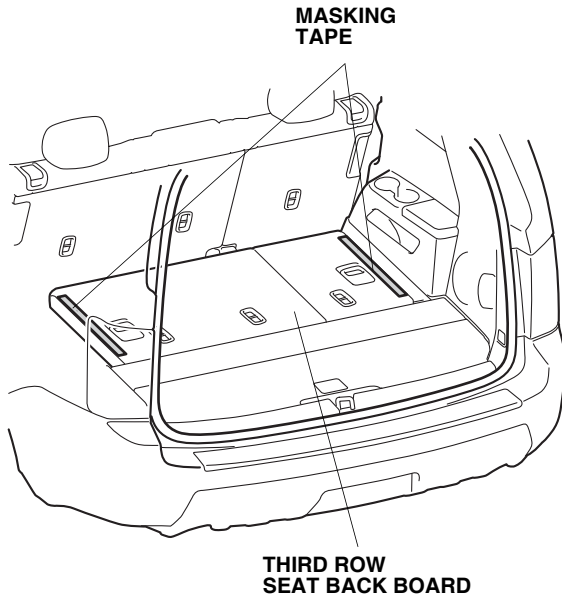

3. Attach masking tape along the outer edge of the third row seat back board as shown.
4. Using a felt-tip pen, measure and mark two locations on the masking tape.

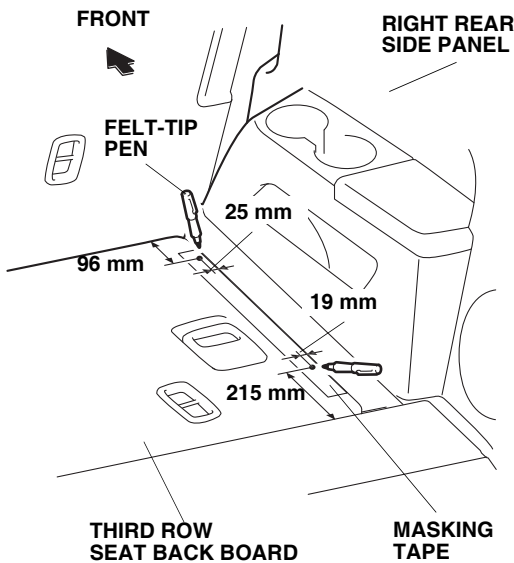

5. Using a felt-tip pen, measure and mark two locations on the masking tape.

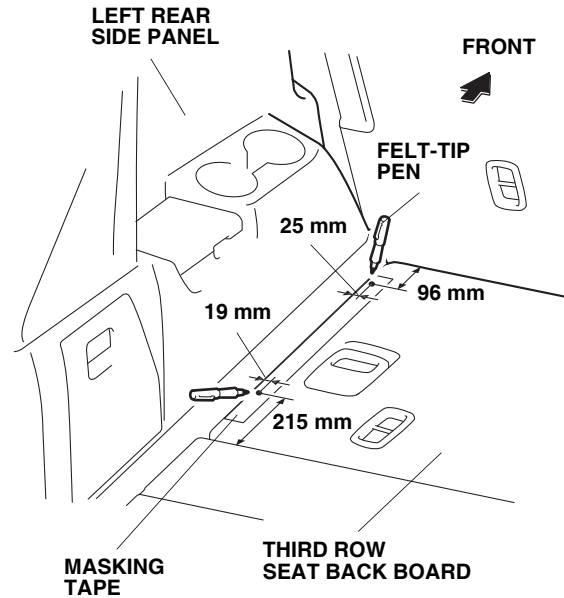

6. While wearing eye protection, drill the two forward marked locations with a 3 mm drill bit, and then with a 5 mm drill bit. Drill through the hard board and the sheet metal. To prevent damage to the seat, wrap tape around the drill bit 25 mm from the tip as shown.

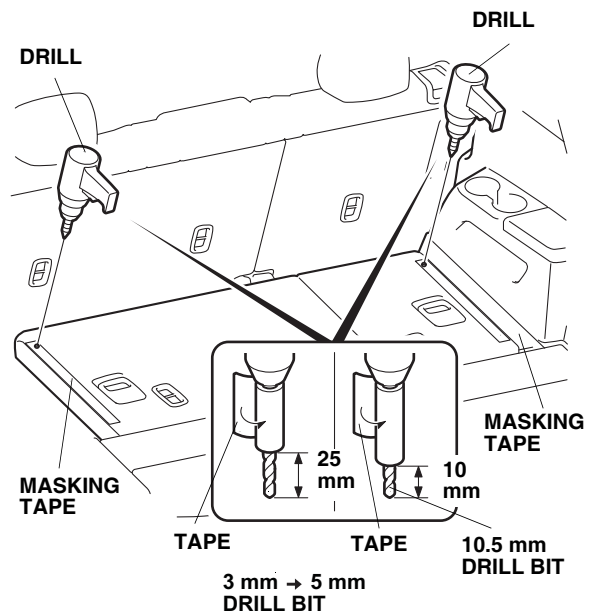

7. Enlarge the holes with a 10.5 mm drill bit. To drill through the hard board only, wrap tape around the drill bit 10 mm from the tip as shown.

8. While wearing eye protection, drill the two rear marked locations with a 3 mm drill bit, and then with a 5 mm drill bit. Drill through the hard board and the sheet metal. To prevent damage to the seat, wrap tape around the drill bit 25 mm from the tip as shown.

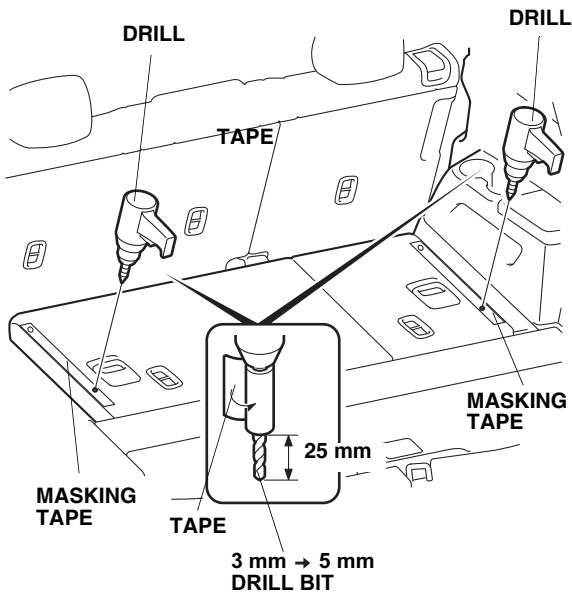

9. Remove the masking tape.
10. Fold down the second row seats. Attach two pieces of masking tape to the second row seat back board as shown.

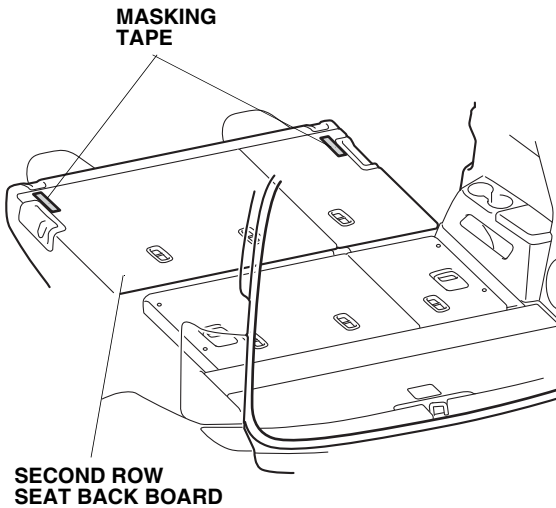

11. Using a felt-tip pen, measure and mark on the masking tape attached in step 10.

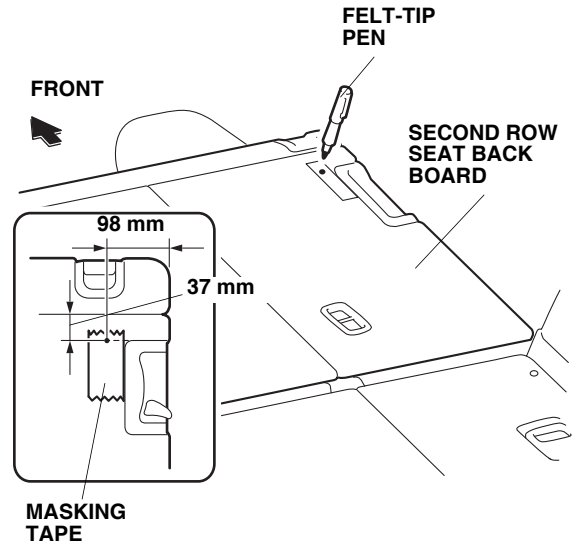

12. Using a felt-tip pen, measure and mark on the masking tape attached in step 10.

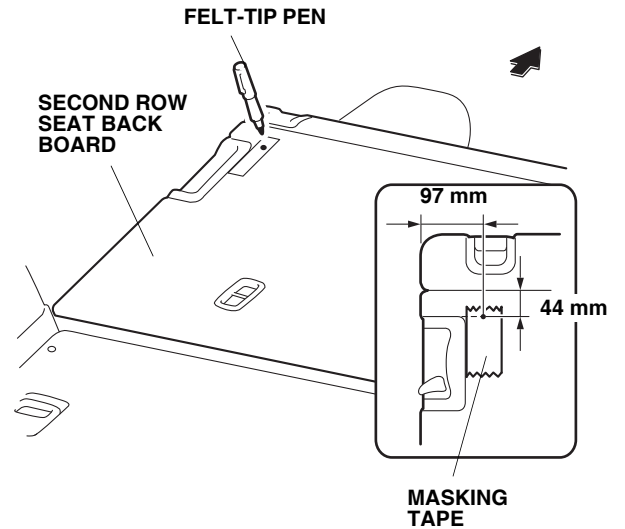

13. While wearing eye protection, drill the marked locations with a 3 mm drill bit, and then with a 5 mm drill bit. Drill through the hard board and the sheet metal. To prevent damage to the seat, wrap tape around the drill bit 25 mm from the tip as shown.

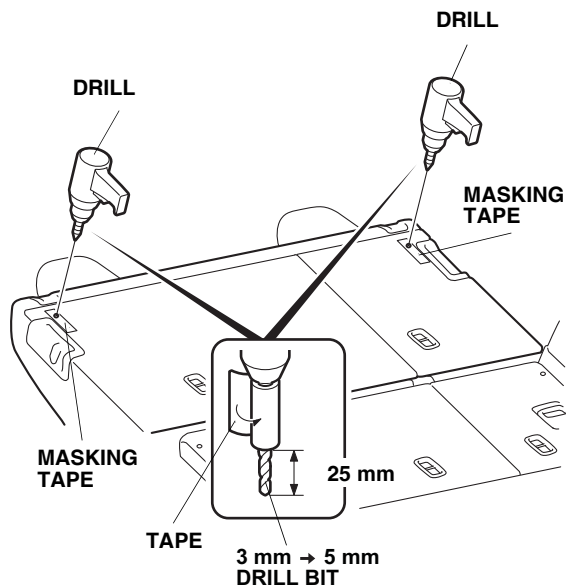

14. Remove the masking tape.  
 15. Assemble two self-tapping screws on the two anchors A (Large).

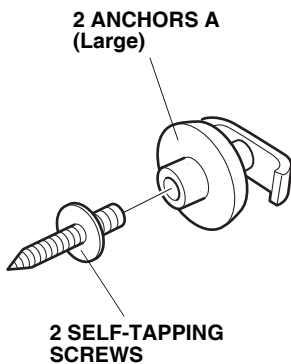

16. Assemble four self-tapping screws on the four anchors B (Small).

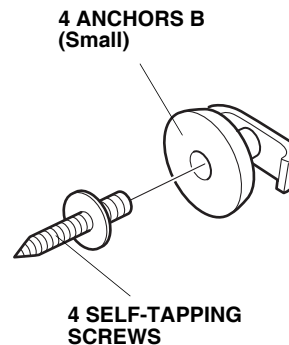

17. Install the two anchors A (Large) on the third row seat back board into the holes made in step 7.

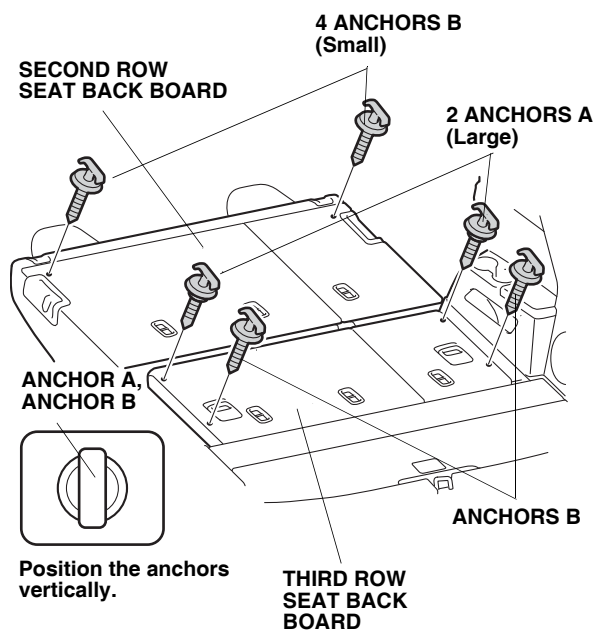

18. Install the four anchors B (Small) on the second and third row seat back boards into the holes made in steps 8 and 13.

## Installing the Advanced Cargo Net

### Position 1

19. Fold down the third row seats.

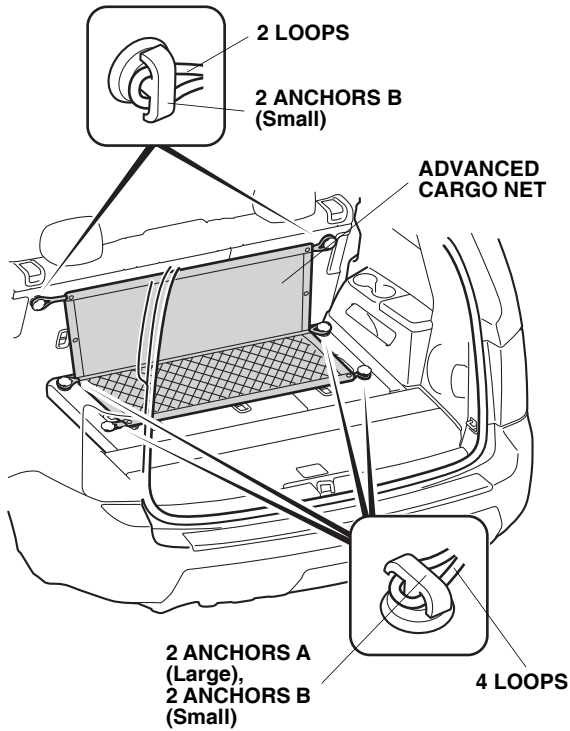

20. Attach six loops on the advanced cargo net to two anchors A (Large) and four anchors B (Small) on the second and third row seat back boards.

### Position 2

21. Fold the advanced cargo net and secure it with two buttons.

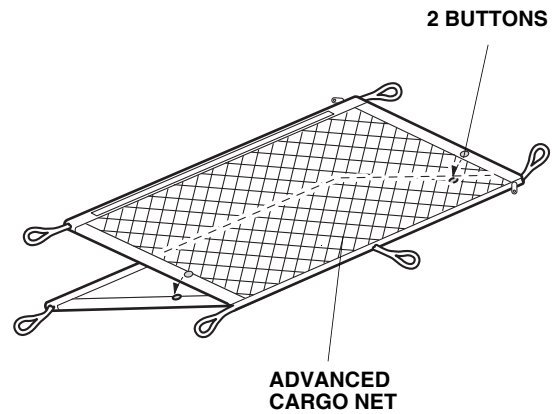

22. Attach five loops on the advanced cargo net to two anchors A (Large), two anchors B (Small) and the hook on the third row seat back board.

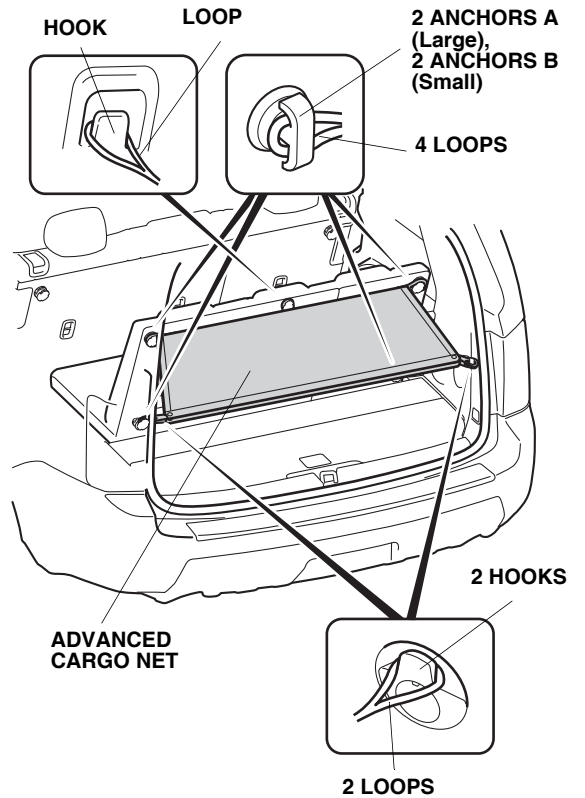

23. Attach two loops on the advanced cargo net to the two hooks.

*Position 3*

24. Attach four snaps onto the advanced cargo net as shown.

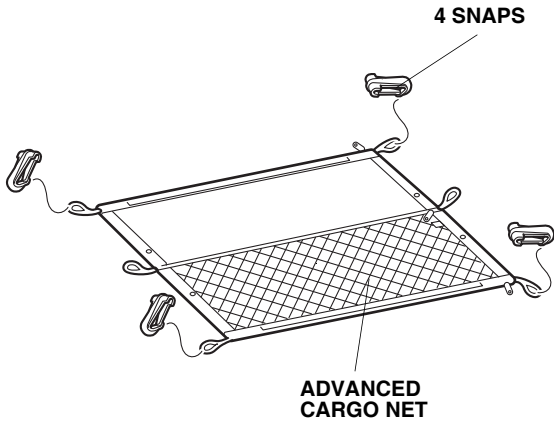

25. Fold down the third row seats.

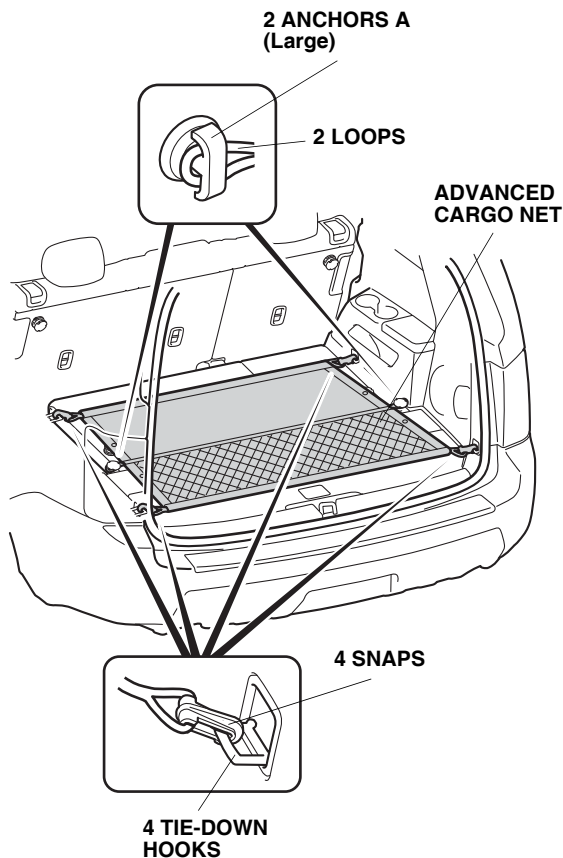

26. Attach the four snaps on the advanced cargo net to four tie-down hooks. Hook two loops on the advanced cargo net to the two anchors A (Large) on the third row seat back board.

*Position 4*

27. Attach two snaps onto the advanced cargo net as shown.

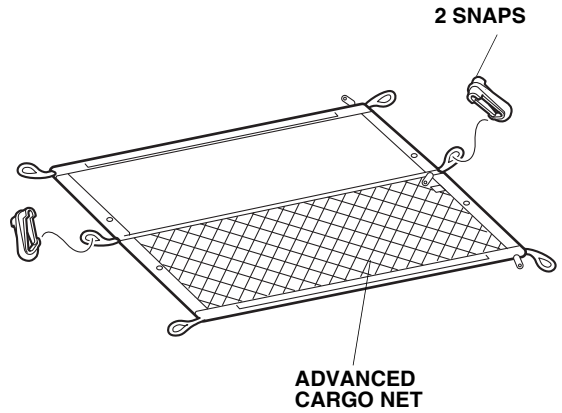

28. Attach four loops on the advanced cargo net to two hooks and two anchors B (Small) on the third row seat back board.

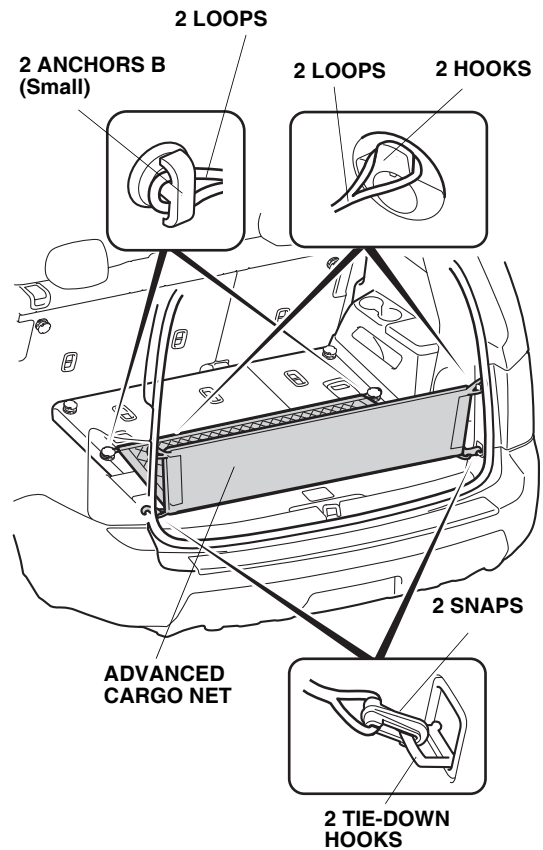

29. Attach the two snaps on the advanced cargo net to two tie-down hooks.