



INSTALLATION INSTRUCTIONS

Accessory
CARGO NET
P/N 08L96-SZA-100

Application
2013 PILOT

Publications No.
All 13306
Issue Date
AUG 2012

Put this information in the glove box with the vehicle owner's manual.

PARTS LIST

Cargo net

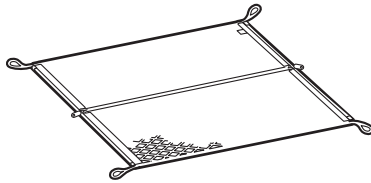

4 Snaps

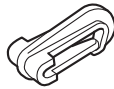

TOOLS AND SUPPLIES REQUIRED

Small flat-tip screwdriver

INSTALLATION

NOTE:

- Some luggage stored in the cargo net may interfere with the tailgate when it is closed. To prevent damage to the cargo net, do not store large or fragile articles in the cargo net.
- Before storing articles that have sharp edges or corners, wrap them with paper or in a blanket so their sharp edges or corners will not tear the cargo net.

Installing the Cargo Net in the Horizontal Position

1. Using a small flat-tip screwdriver, push and release the seat belt lower hook from each third row seat. Insert the seat belt lower hooks into the side slots.

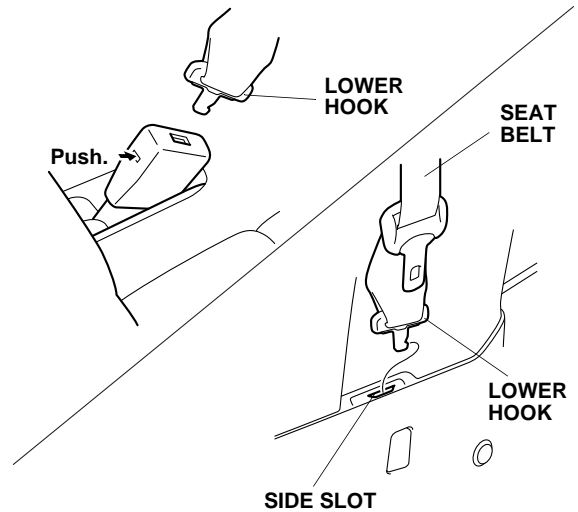

2. Attach four snaps onto the cargo net as shown.

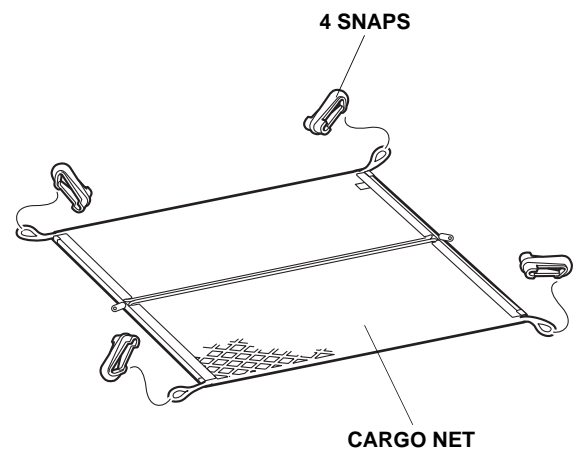

3. Fold down the third row seats.

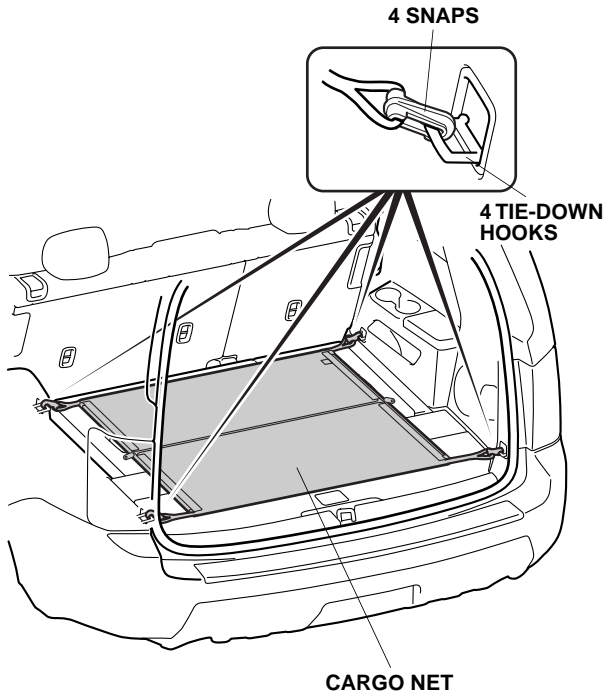

4. Attach four snaps on the cargo net to the four tie-down hooks in the cargo area.

Installing the Cargo Net in the Vertical Position

5. Fold the cargo net and zip up the two zippers.

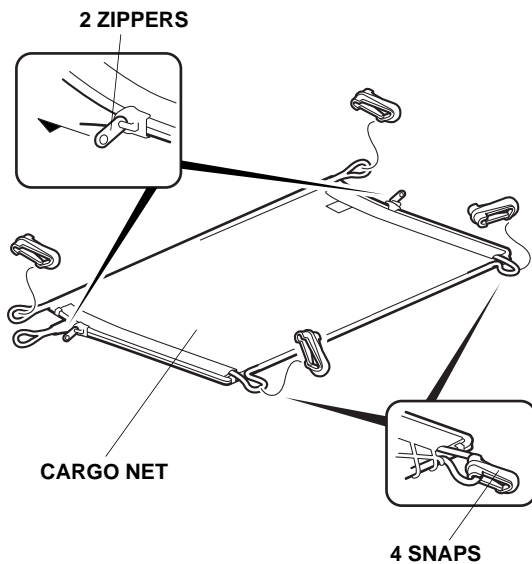

6. Attach four snaps onto the cargo net as shown.

7. Attach the upper two loops on the cargo net to the two anchors. Then attach the two upper snaps on the cargo net to the two upper loops as shown.

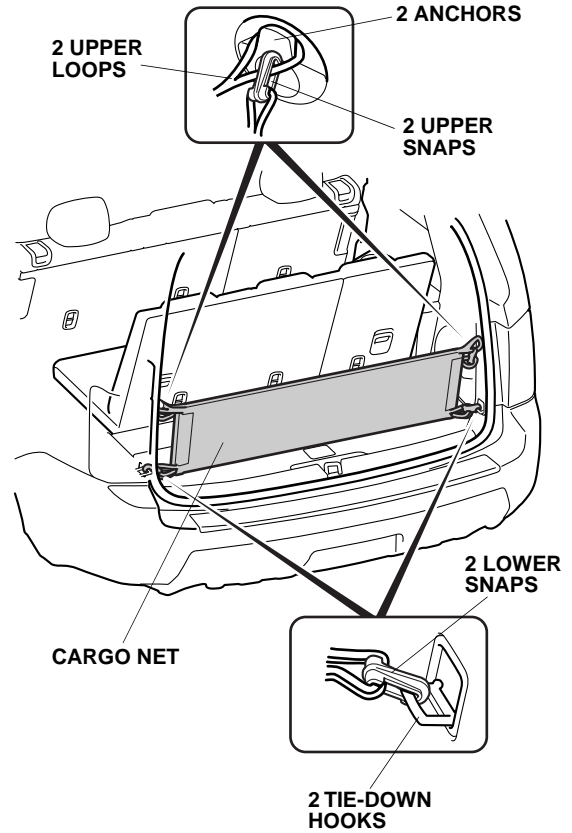

8. Attach the two lower snaps on the cargo net to the two tie-down hooks.