



INSTALLATION INSTRUCTIONS

Accessory
**BICYCLE ATTACHMENT
(HITCH MOUNT)**
P/N 08L14-E09-101

Application
2013 PILOT

Publications No.
All 13300
Issue Date
AUG 2012

Keep this information in the glove box for future reference.

PARTS LIST

Upright and bicycle arm
bracket assembly

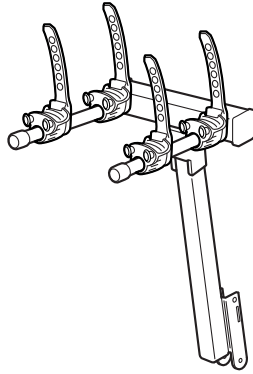

Lower bracket assembly

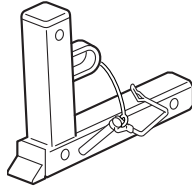

Bolt, 12 x 40 mm



Bolt, 8 x 70 mm



2 Washers, 8 mm



Washer, 12 mm



Lock washer



Nut, 8 mm



Hitch tool

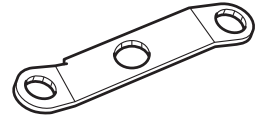

Strap



2 Anti-sway cage assemblies

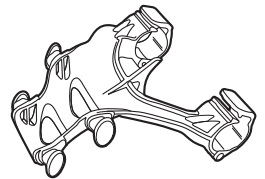

2 Anti-sway straps

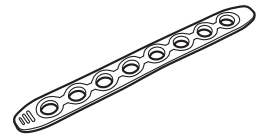

INSTALLATION

NOTE: Do not damage the finished surfaces of the body when installing the bicycle carrier.

Installing the Bicycle Attachment

1. Position the lower bracket assembly into the upright and bicycle arm bracket assembly as shown.

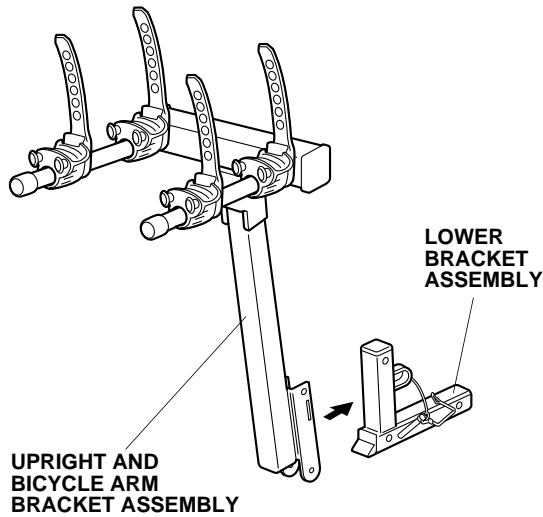

2. Install the 8 x 70 mm bolt, two 8 mm washers, and 8 mm nut as shown. Tighten the bolt securely.

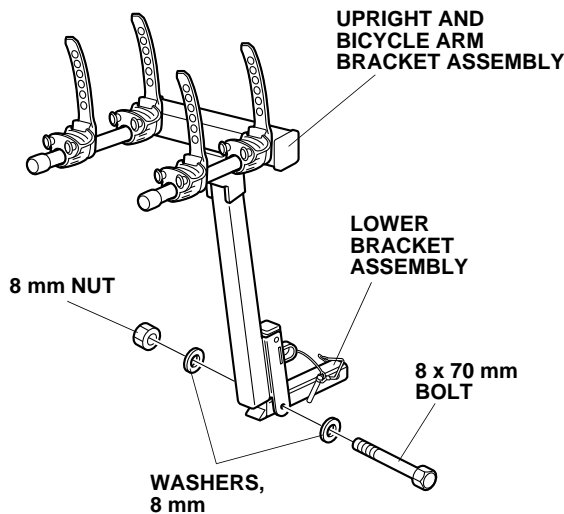

3. Install the pin and safety hook as shown.

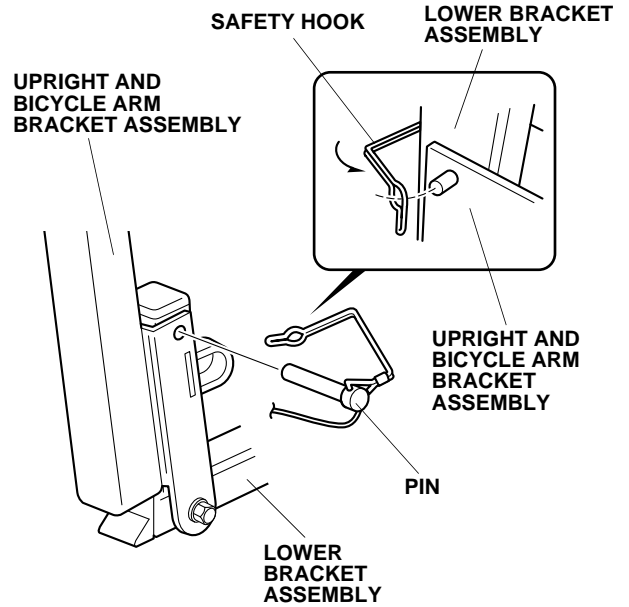

4. Slide the lower bracket assembly into the trailer hitch receiver until the hole in the bracket lines up with the receiver hole. Install the 12 x 40 mm bolt with a lock washer and a 12 mm washer through the receiver hole. Tighten the bolt securely.

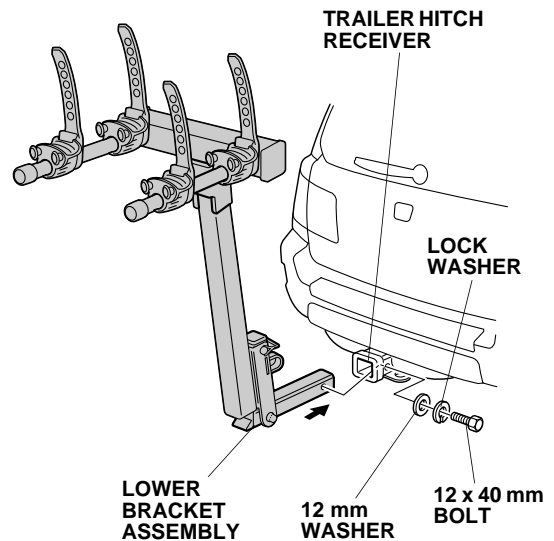

Loading the Bicycles

NOTE: Carry no more than 2 bicycles on the bicycle rack.

1. Place the heaviest bicycle onto the inner cradle. The cradles can be rotated or shifted on the bars to accommodate different styles of bicycles.

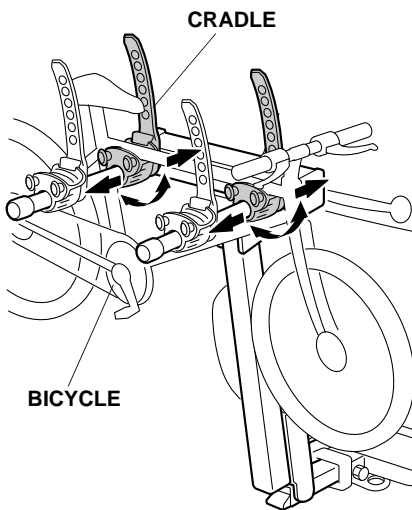
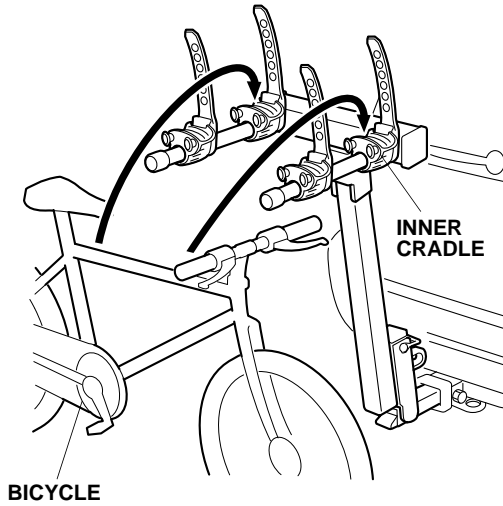

2. Install the two anti-sway cage assemblies to the bicycle arms as shown.

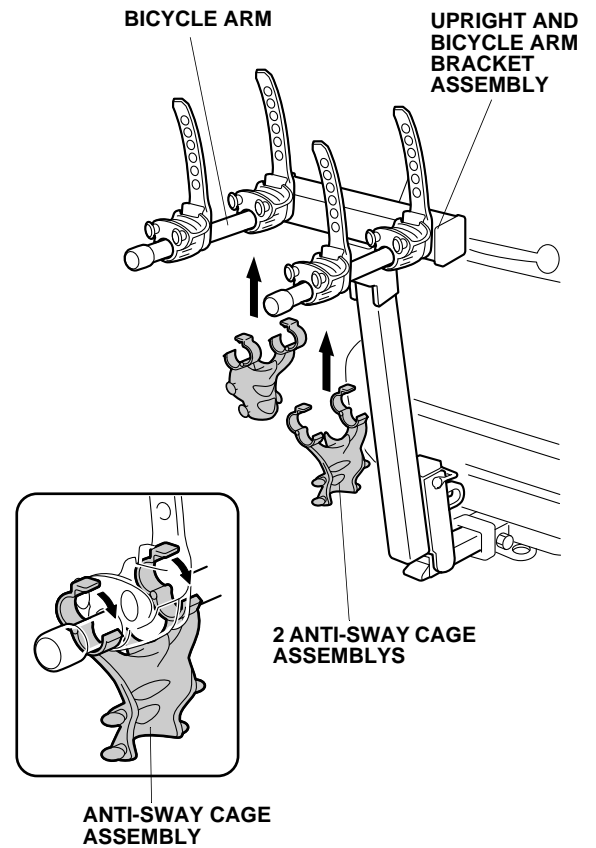

3. Tighten the bicycle arm straps securely around the bicycle frame.

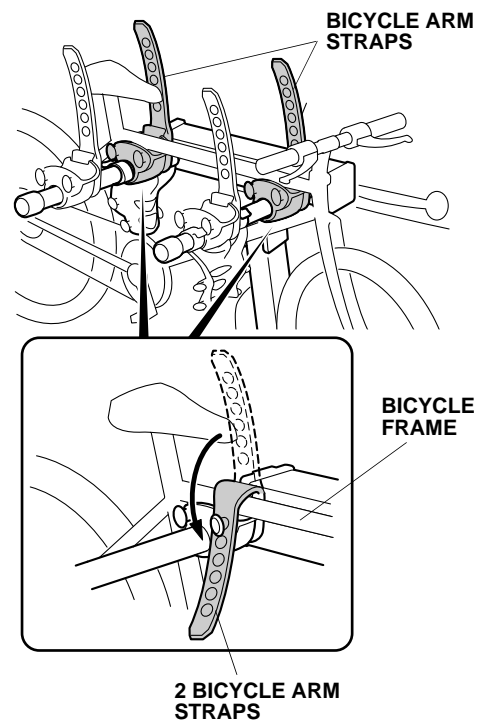

4. Install the two anti-sway straps and tighten each anti-sway strap securely around the bicycle frame.

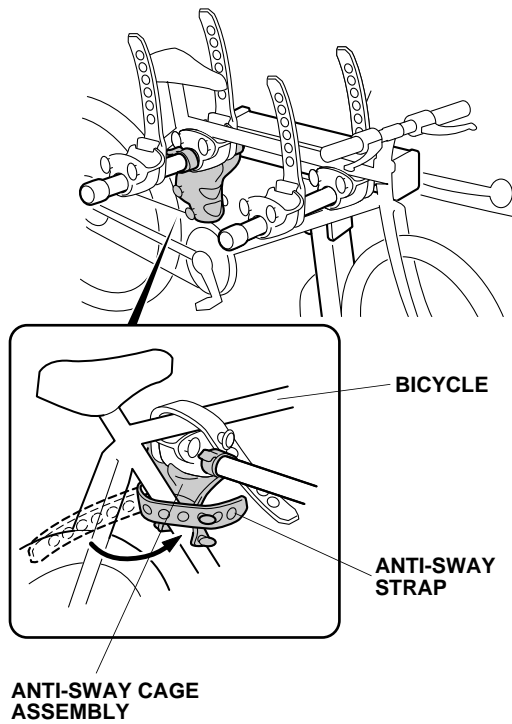

5. Using the strap provided, secure the bicycle wheels. Secure the strap buckle as shown.

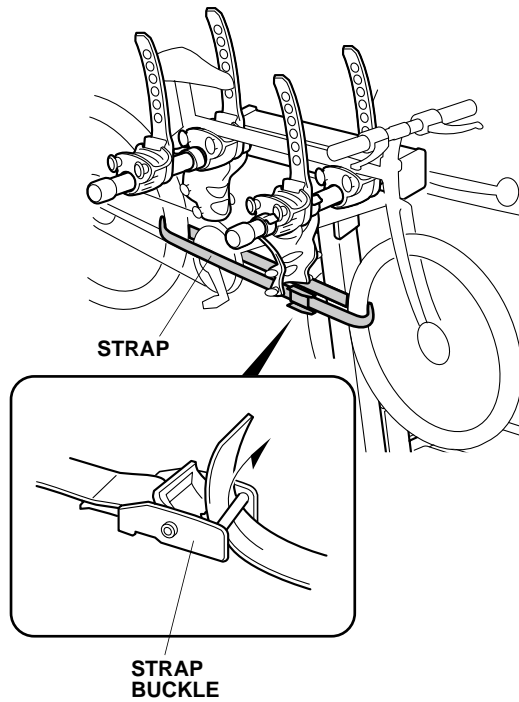

NOTE: After loading the bicycle(s), confirm that the view of the vehicle's rear lights is not blocked.

6. When loading two bicycles, alternate the direction of the bicycles.

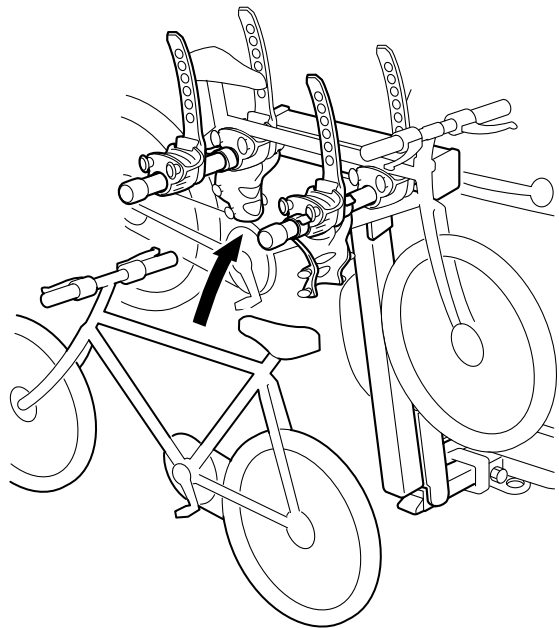

With No Bicycles Loaded

1. Release the safety hook by pulling outward to remove it from the pin. Support the bicycle arm bracket assembly and slide the pin out. Gently lower the bicycle arm bracket assembly to the stop position.

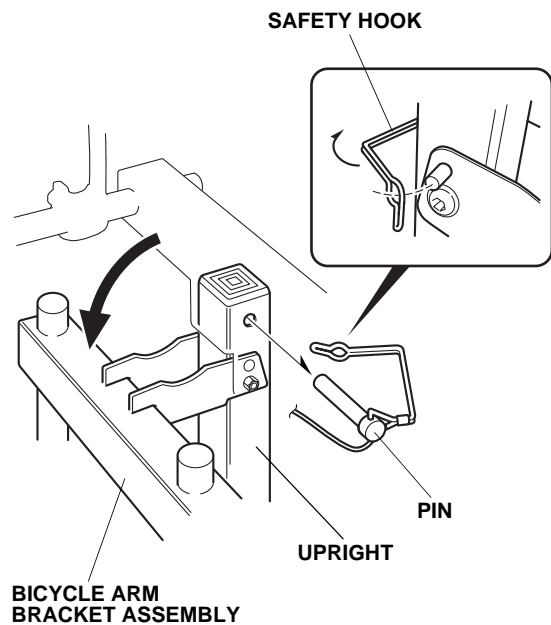

2. Reinstall the pin and safety hook as shown.

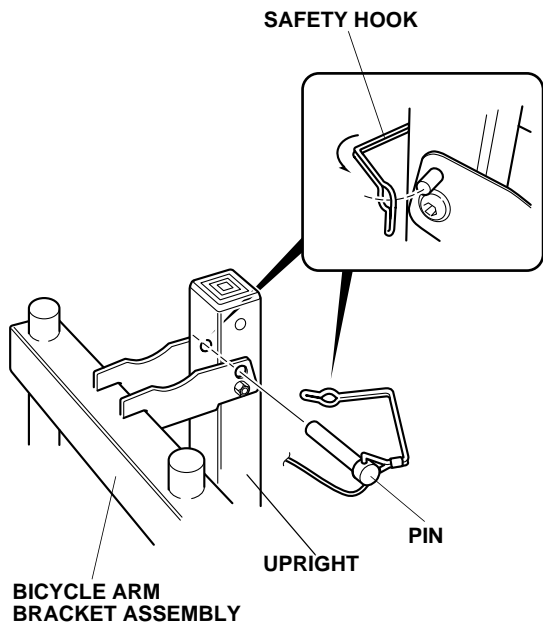

Opening the Tailgate

1. All bicycles must be removed. Release the safety hook by pulling outward to remove it from the pin. Support the upright and bicycle arm bracket assembly, then slide the pin out

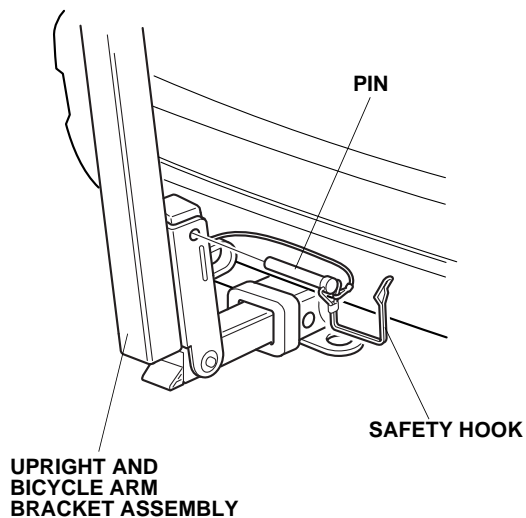

2. Gently lower the upright and bicycle arm bracket assembly to the stop position.

