



INSTALLATION INSTRUCTIONS

Accessory
CARGO COVER

Application
2011 CR-V

Publications No.
All 44615
Issue Date
AUG 2010

Put this information in the glove box with the vehicle owner's manual.

PARTS LIST

Cargo cover

P/N: 08Z07-SWA-110 (Black)

P/N: 08Z07-SWA-120 (Ivory)

P/N: 08Z07-SWA-130 (Gray)

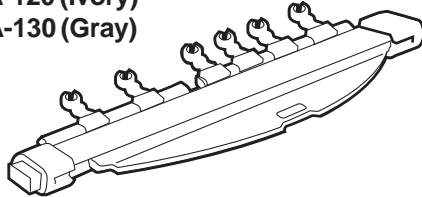

2 Adhesive tapes

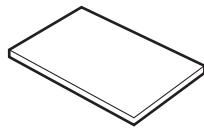

SUPPLIES REQUIRED

Flat-tip screwdriver

Clean soft cloth

INSTALLATION

Installing the Cargo Cover

1. Open the tailgate. Using a flat-tip screwdriver, remove the panel covers from the right and left rear side trim panels.

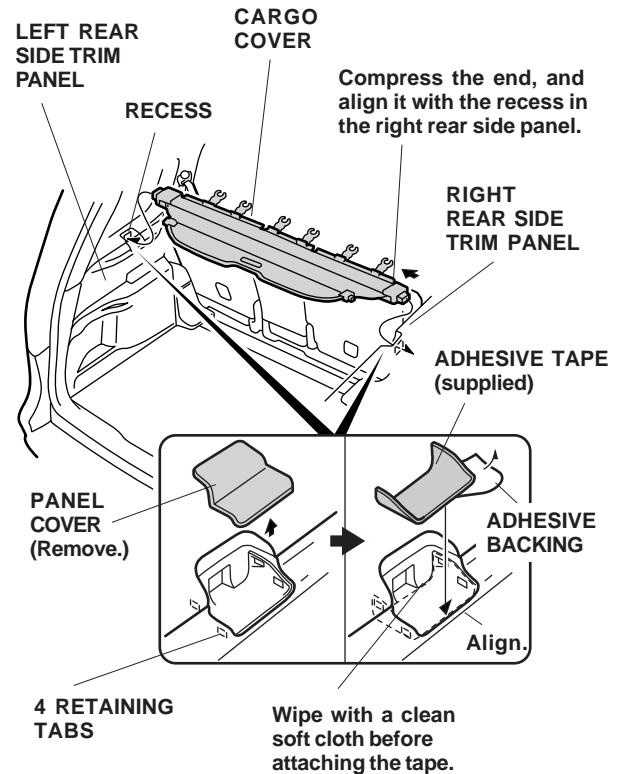

2. Using a clean soft cloth, clean the areas where the panel covers were removed. Remove the adhesive backings from the adhesive tapes, and attach the tapes to the right and left rear side trim panels where the panel covers were removed.
3. Insert the left end of the cargo cover into the recess in the left rear side trim panel; compress the cargo cover, and insert the right end into the recess in the right rear side trim panel as you release the cover.

- Attach the six front roll cover hooks to the rear seat headrest posts as shown.

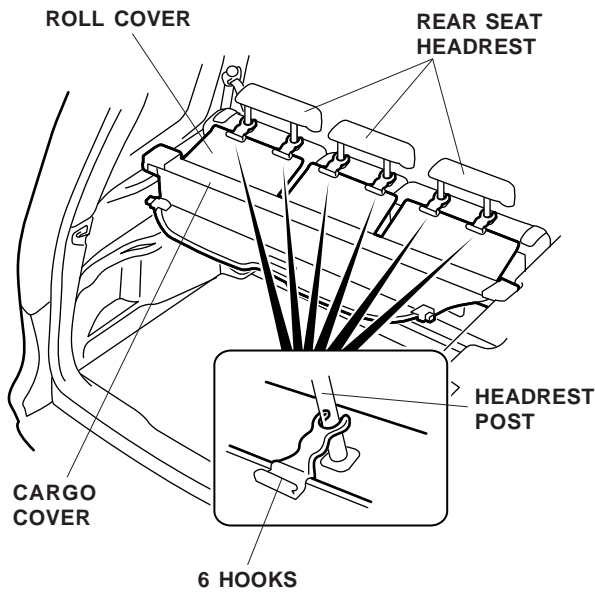

- Slide both ends of the rear roll cover rod into the recesses in the rear side trim panel.

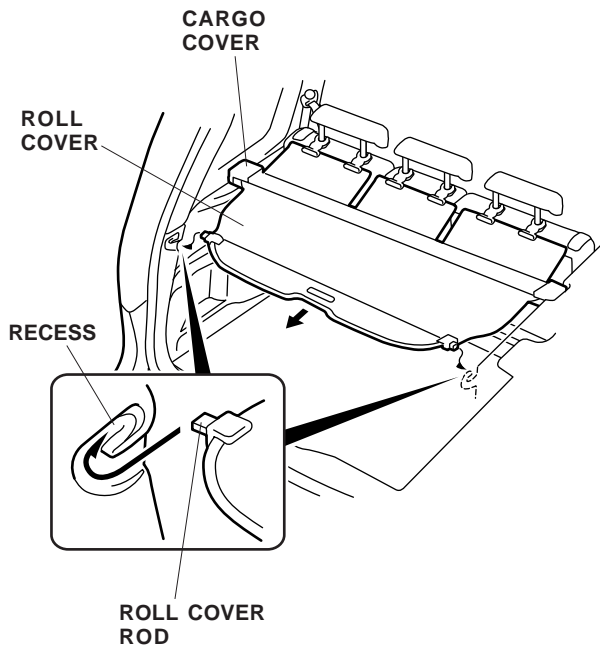

Storing the Cargo Cover

- Insert the right end of the cargo cover into the recess in the right rear side trim panel, and compress the cargo cover. Insert the left end of the cargo cover into the recess in the left rear side trim panel by compressing the cargo cover and aligning the end with the recess in the left rear side panel.

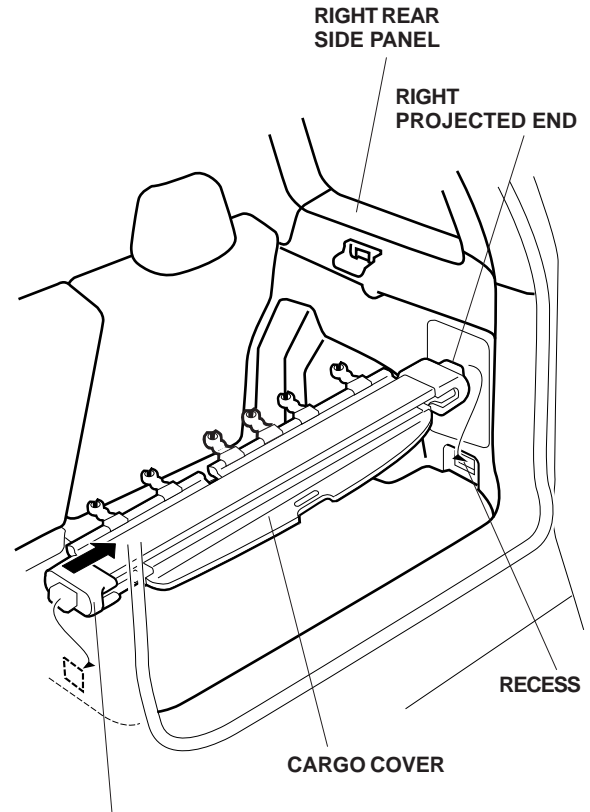

Compress the end, and align it with the recess in the left rear side panel.

USE AND CARE

- The front roll cover cannot be used when the rear seat is stored.
- Do not place cargo on the front and rear roll covers.
- Do not hang anything from the roll cover hooks.