



INSTALLATION INSTRUCTIONS

Accessory

TRUNK DIVIDER
P/N 08U35-SJC-120

Application

2010 RIDGELINE

Publications No.

All 42162

Issue Date

AUG 2009

Put this information in the glove box with the vehicle owner's manual.

PARTS LIST

3 Trunk dividers

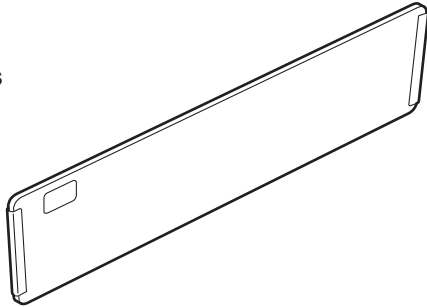

1. Open the tailgate, then open the in-bed trunk lid. Insert the trunk dividers into the six grooves (three grooves in the front and three grooves in the rear). Install each trunk divider with the arrow pointing toward the front of the vehicle.

Install the trunk divider with the arrow pointing toward the front of the vehicle.

