



INSTALLATION INSTRUCTIONS

Accessory

ROOF BOX (MID-SIZE)
P/N 08L20-TA1-100A

Application

2010 PILOT

Publications No.

All 41655

Issue Date

MAY 2009

Put this information in the glove box with the vehicle owner's manual.

PARTS LIST

Roof box

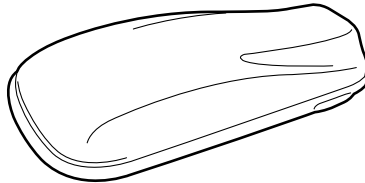

4 Brackets A

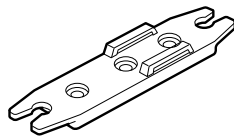

4 Brackets B

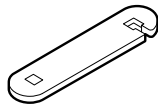

4 Plates

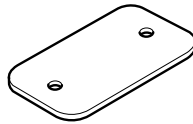

8 Knobs



8 Bolts



8 Washers



2 Straps

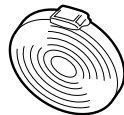

Seal

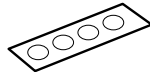

2 Keys



4 Large pads

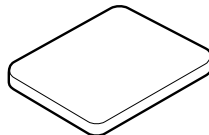

4 Small pads



SUPPLIES REQUIRED

Isopropyl alcohol

Shop towel

INSTALLATION

NOTE:

- Be careful not to damage the roof and other finished surfaces of the body when installing the roof box.
- Do not allow the combined weight of the accessory and cargo to exceed the carrying capacity of the roof rack.
- An optional Honda roof rack (sold separately) is required to install the roof box.

1. With the help of an assistant, carefully place the box on the crossbars. Open the tailgate to make sure that the box is not interfering with the tailgate.

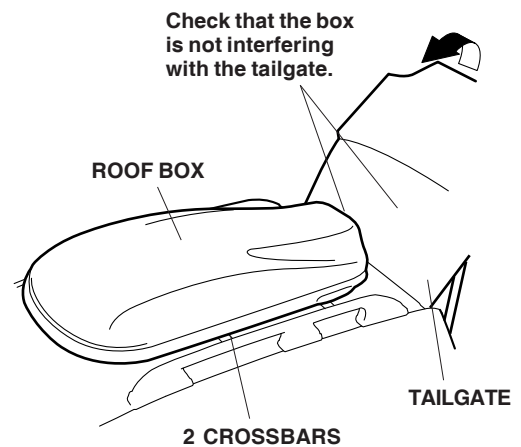

- Open the roof box. Slide the plate forward or backward until the holes in the plate are over the front roof rack crossbar. The plate is located near the front of the roof box.

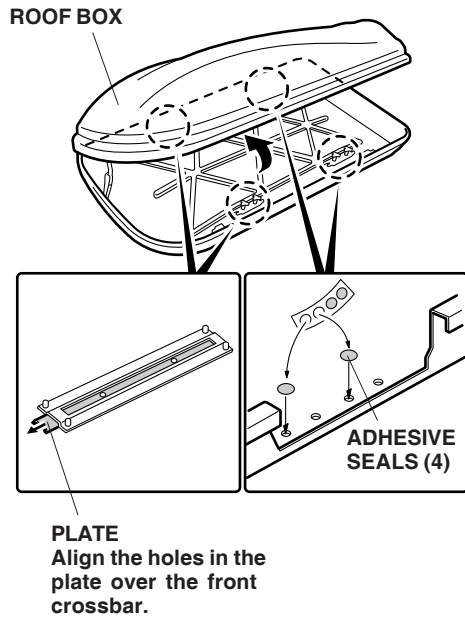

- Attach an adhesive seal over the unused rear mounting holes along the bottom of the roof box. The seal will help prevent water from entering the roof box. Remove the roof box from the vehicle.

- Using isopropyl alcohol on a shop towel, clean the four brackets B where the small pads will attach. Remove the adhesive backings from the small pads and attach them to the brackets B.

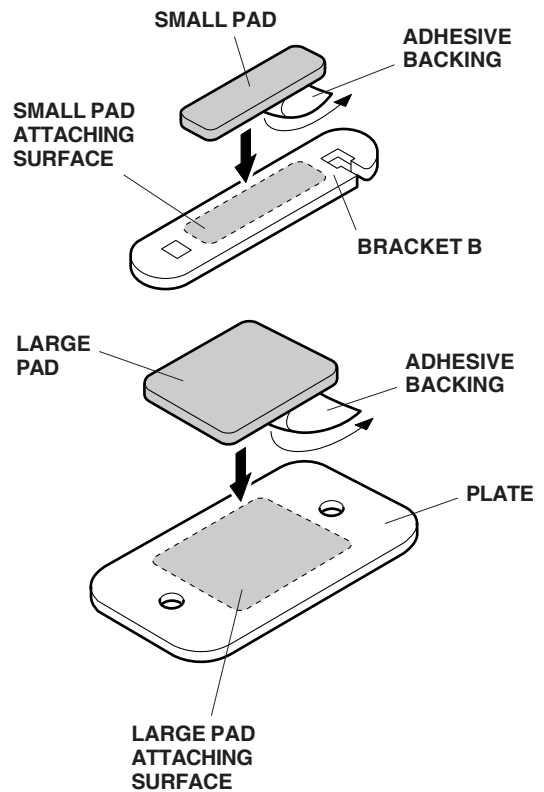

- Using isopropyl alcohol on a shop towel, clean the four plates where the large pads will attach. Remove the adhesive backings from the large pads and attach them to the plates.

- Under the roof box, insert a bolt through bracket B, through the plate and into the predrilled hole in the bottom of the roof box.

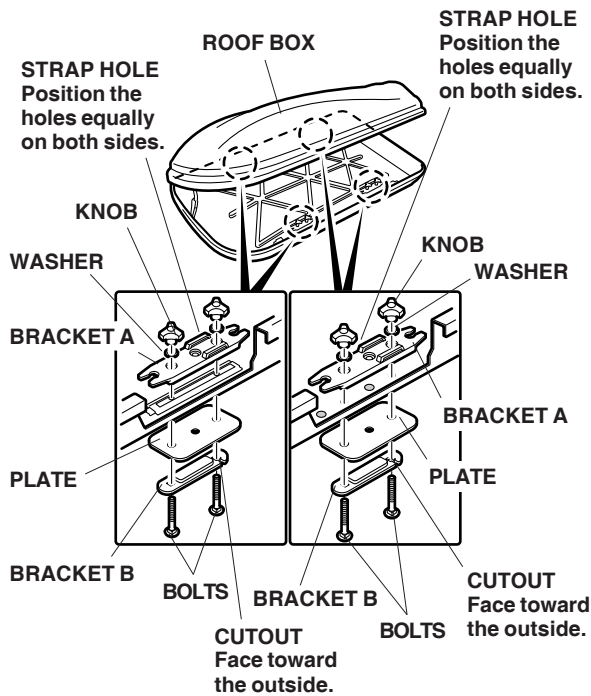

- Fit bracket A over the threads of the bolt where it goes through the roof box. Install a washer over the threads, and loosely install a knob. Install a second bolt the same way.
 - Adjust bracket A so that the right and left strap holes are positioned equally on both sides.
 - Install bracket B with the cutout facing the outside.

- With the help of an assistant, carefully place the box on the crossbars. Be aware of the hardware hanging from the bottom of the box.

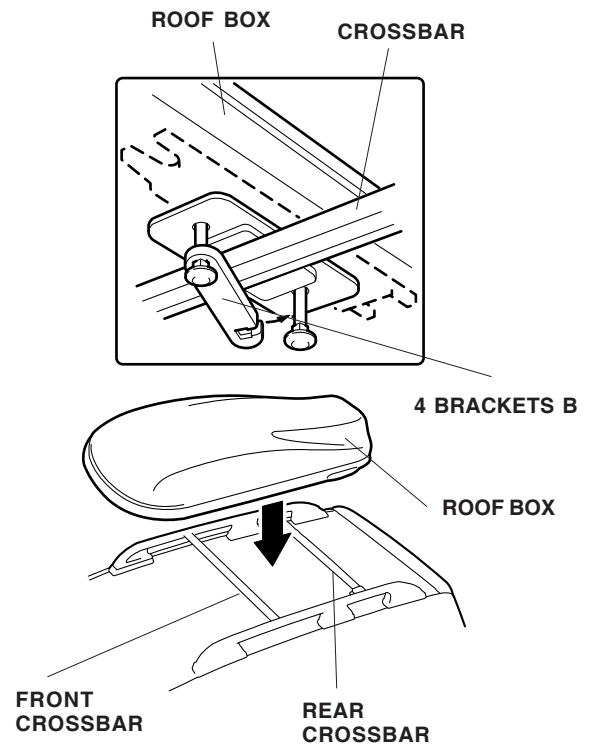

- Arrange the plate to fit between the box and the crossbar. Swing the slotted end of bracket B around the bolt, and tighten the knobs. Fasten the box this way at all four mounting points.
 - If necessary, adjust the distance between the crossbars to match the pattern of the predrilled holes in the roof box. The maximum possible distance between the crossbars should be used. Additional holes can be drilled in the bottom of the roof box without affecting its stability or load capacity. The minimum bar spread required is 21 5/8" for all racks.
 - The roof box should be centered on the crossbars and parallel to the direction of travel with its flat side facing the front.

10. Insert the straps through the eyelets on bracket A, and attach the straps together.

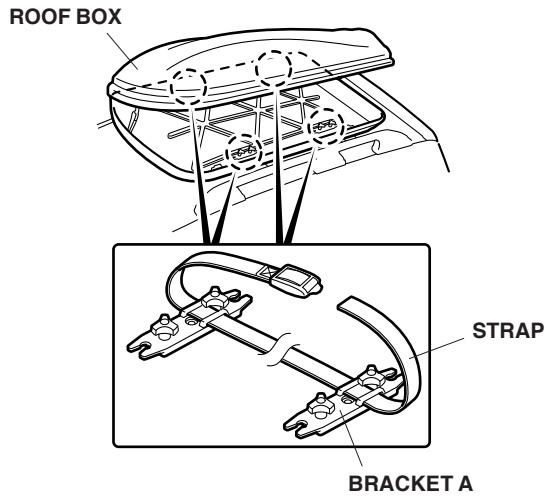

USE AND CARE

NOTE:

- This roof box can be opened on either side. However, the box can only be opened from one side at a time.
- Before opening the roof box from either side, be sure that the box is securely closed on the other side.

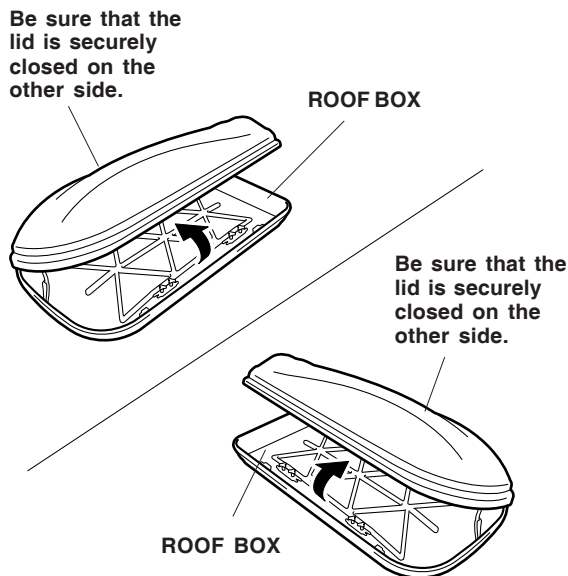

Unlocking/Locking the Roof Box

NOTE:

- The key is attached to the inside of the roof box.
- The locks works the same way from either side of the box.

Unlocking: Insert the key into the lock and turn it counterclockwise to unlock. Press the center button while lifting the roof box lid.

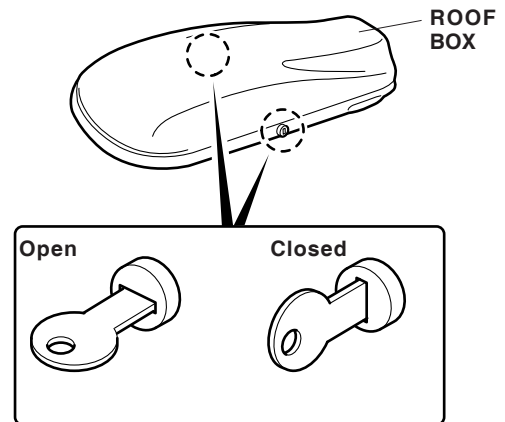

Locking: Press down on the lid. There should be an audible click. Be sure the lid is latched by attempting to lift the lid. Turn the key clockwise to lock the roof box. Remove the key while not in use. Make sure the straps do not dangle from the roof.

LOADING THE ROOF BOX

Load weight equally on both sides to minimize imbalance. Do not overload the roof box. The maximum allowable load is 110 lb (50 kg).

Loads must be secured with the straps to prevent them from sliding. Check the fasteners at regular intervals.