



# INSTALLATION INSTRUCTIONS

Accessory  
**FULL NOSE MASK**  
P/N 08P35-TK6-100A

Application  
**2010 FIT**  
(Sport Model)

Publications No.  
**All 47048**  
Issue Date  
**AUG 2011**

## PARTS LIST

Mask (hood section)

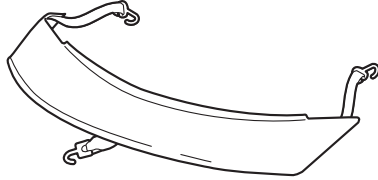

Mask (bumper section)

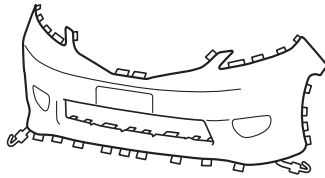

2 Snap-screws

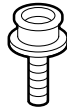

2 Washers



2 Spring nuts



Elastic cord

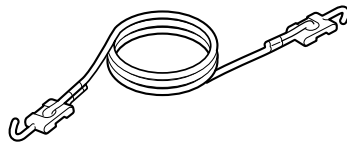

Storage bag

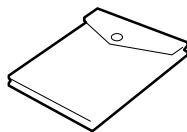

## TOOLS AND SUPPLIES REQUIRED

Stubby Phillips screwdriver

Flat-tip screwdriver

Shop towel

Scissors

## INSTALLATION

### NOTE:

- Make sure the vehicle and the nose mask are clean and completely dry before installation. If moisture under the mask is allowed to dry, it may cloud the paint. If the mask gets wet, remove it and allow it to air-dry completely.
- Make sure any repainted surfaces are cured.
- Wax the hood and nose of the vehicle with a high-quality paste wax.
- Install the nose mask securely. If the nose mask starts to flap or comes loose while driving, safely pull off the highway, stop the vehicle, and secure or remove the mask.

### Displaying the License Plate

If your state law requires the display of both license plates, cut out the piece of the bumper section that covers the front license plate:

- Face the inside of the mask toward you.
- Carefully cut the red overcast stitching with scissors and remove the license plate section.

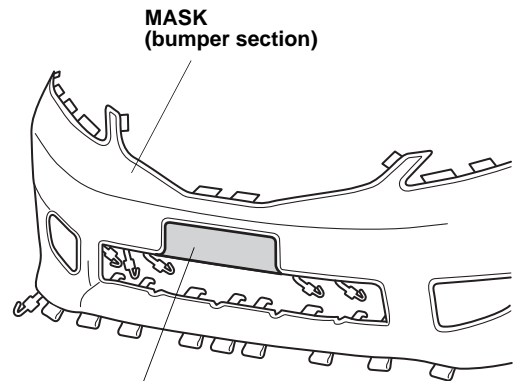

**OVERCAST STITCHING**  
Remove for license plate.

## Installing the Hood Section

1. Open the hood. Fit the corners of the hood section around the hood. Adjust the hood section so it fits smoothly over the edges. Attach the three "S" hooks to the hood.

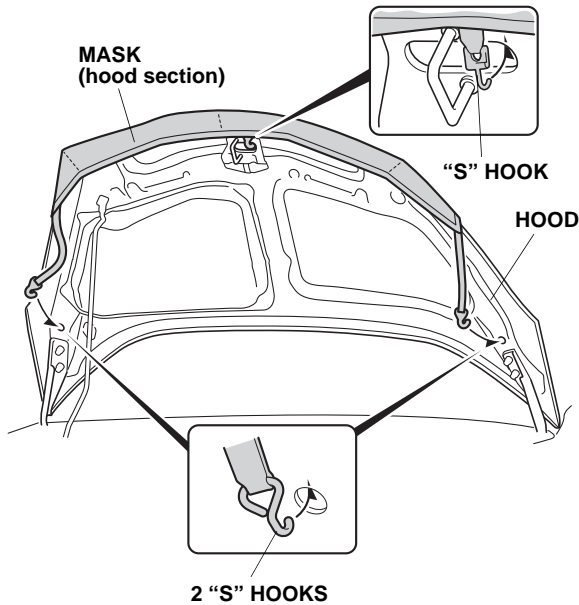

## Installing the Bumper Section

2. Turn the steering wheel all the way clockwise.
3. Remove and retain the expansion clip that fastens the inner fender. Clean the area around the hole.

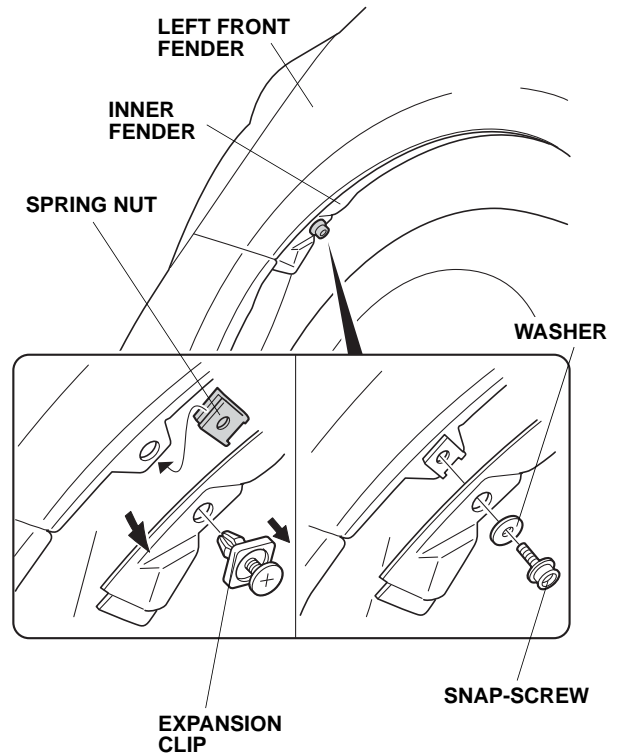

4. Pull back the inner fenderwell and install the spring nut over the hole in the fender.
5. Install a snap-screw with a washer as shown.
6. Turn the steering wheel all the way counterclockwise and repeat steps 3 through 5 to install a snap-screw on the other side of the vehicle.

7. Attach the pockets on the mask to the front bumper as shown.

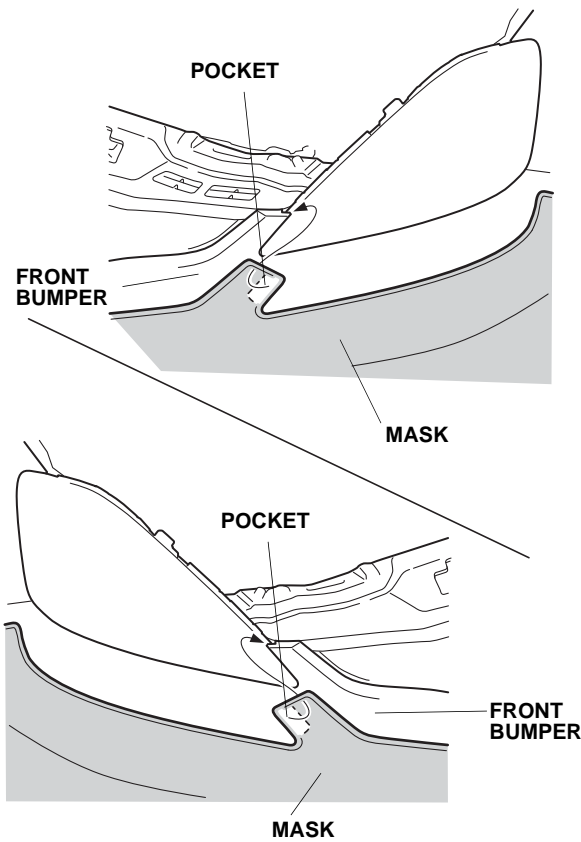

8. Insert four tabs into the opening between the front grille and the front bumper.

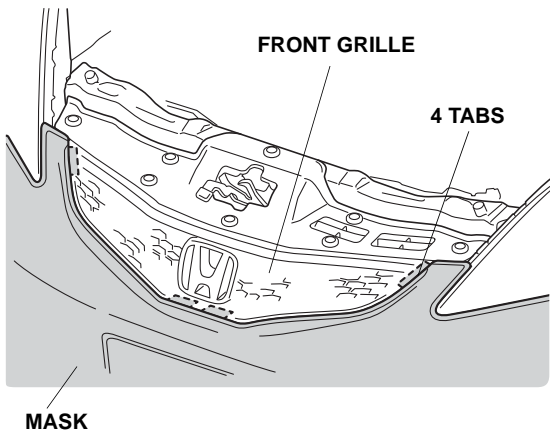

9. Attach the two hooks to the lower grille opening.

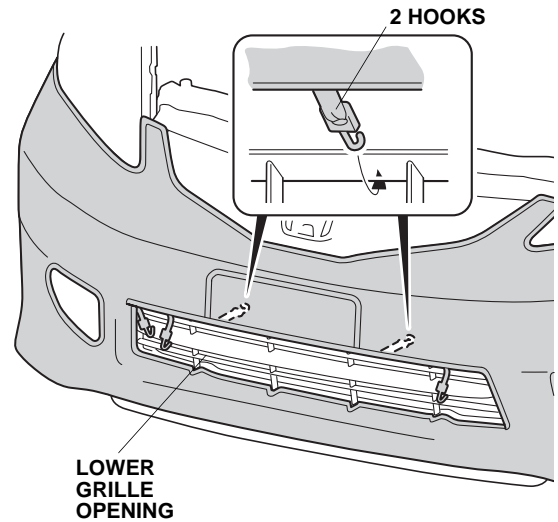

10. Install the four tabs into the opening between the left headlight and the bumper. Starting with the back tab, insert each tab between the headlight and the bumper and slide it backward.

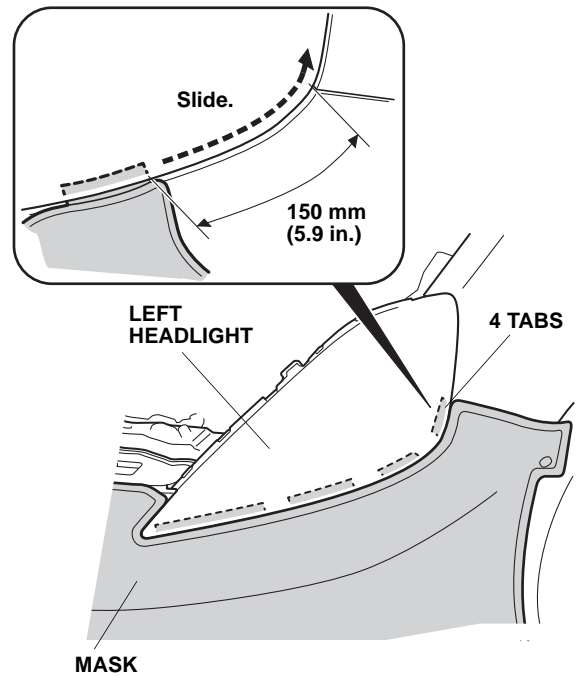

11. Repeat step 10 to install the mask on the right side of the vehicle.

- Pull the mask toward the wheelwell, smooth out any wrinkles, and snap the mask to the snap-screw. Attach the four plastic hooks to the fenderwell.

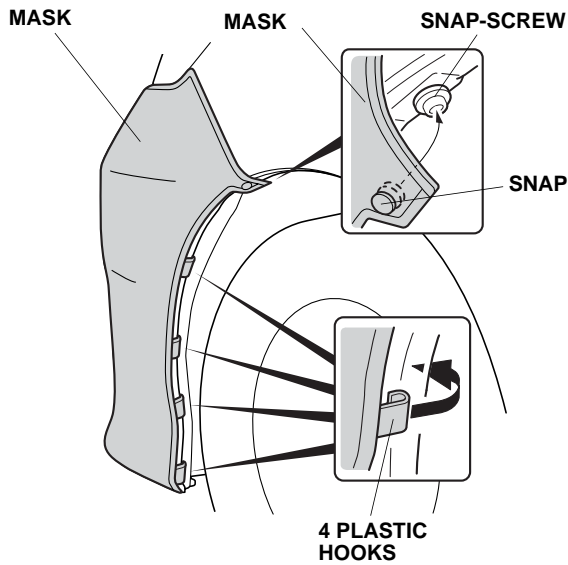

- Repeat step 12 to install the mask on the right side of the vehicle.
- Route the elastic cord through the nine loops on the bottom of the mask. Attach the four hooks to the bottom of the bumper.

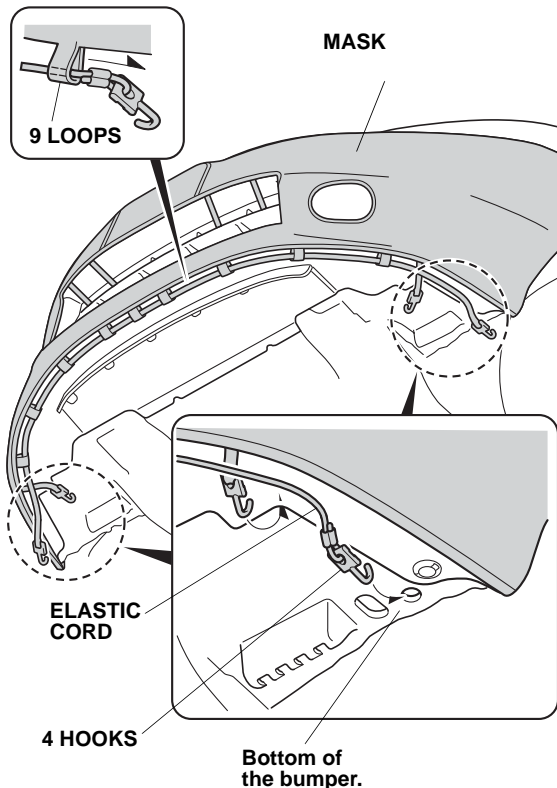

- Attach the four hooks to the lower grille opening. Attach the eight plastic hooks to the bottom edge of the lower grille.

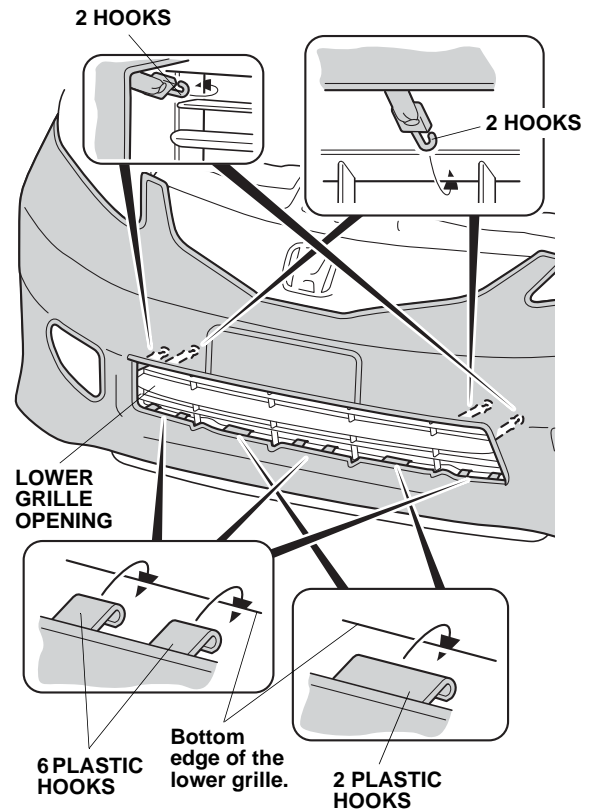

- Put these instructions and expansion clips into the storage bag for future use.

### CLEANING THE NOSE MASK

Use a sponge or cloth and a solution of mild liquid dishwashing soap and water to clean the vinyl and the flannel backing. Rinse the mask completely with clean water, and hang it to dry out of direct sunlight. Make sure the mask is completely dry before you reinstall it.