



# INSTALLATION INSTRUCTIONS

Accessory  
**SIDE STEP**  
P/N 08L33-SWA-100C(Black)  
P/N 08L33-SWA-100D(Chrome)

Application  
**2010 CR-V**

Publications No.  
**All 42616**  
Issue Date  
**AUG 2009**

## PARTS LIST

Right side step

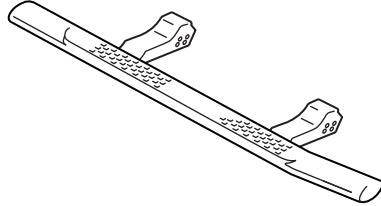

Left side step

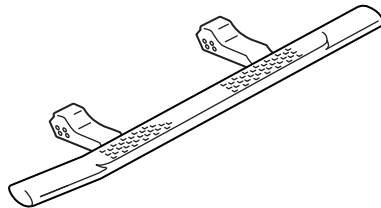

4 Brackets

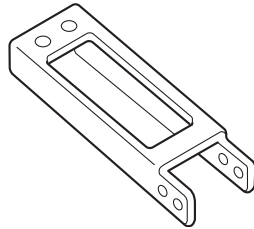

16 Flange nuts, 8 mm

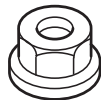

32 Flange bolts, 8 x 20 mm

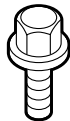

## TOOLS AND SUPPLIES REQUIRED

Clip remover  
Utility knife  
Torque wrench

## INSTALLATION

**Customer Information:** The information in this installation instruction is intended for use only by skilled technicians who have the proper tools, equipment, and training to correctly and safely add equipment to your vehicle. These procedures should not be attempted by "do-it-yourselfers."

### NOTE:

- Thoroughly clean the bottom of the body between the front and rear wheels.
- Be careful not to damage the body paint finish. To prevent damage, place a blanket under the side step board during the installation.
- These instructions show the left side running board being installed; the same procedure applies to installing the right side step.

1. Under the vehicle, remove the left undercover from the vehicle (four clips and three bolts).

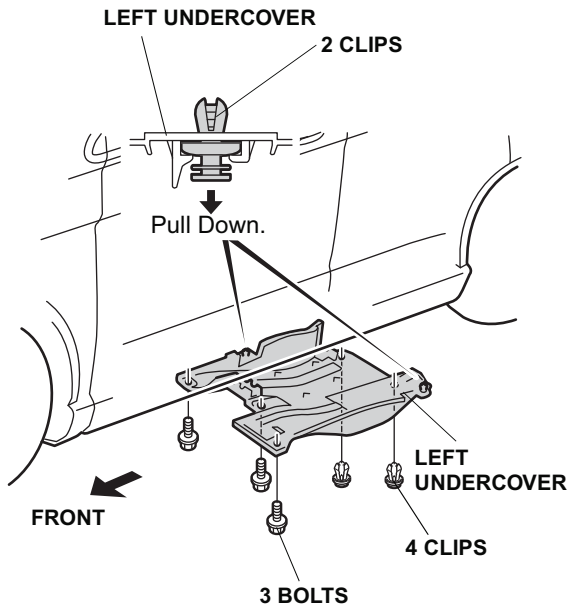

2. Remove the right undercover in the same manner.

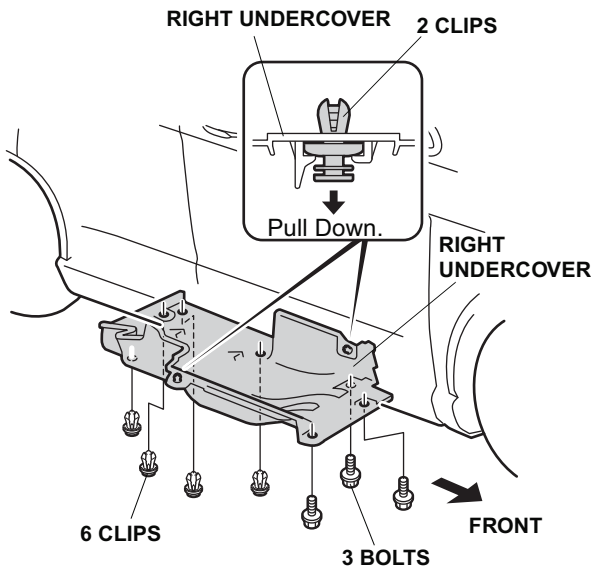

3. Cut out the left undercover along the dotted marks on the inside of the undercover. Remove any burrs at the edge of the cutout.

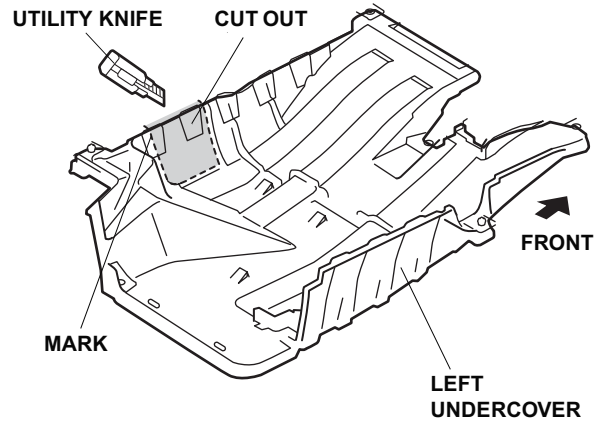

4. Cut out the right undercover the same way.

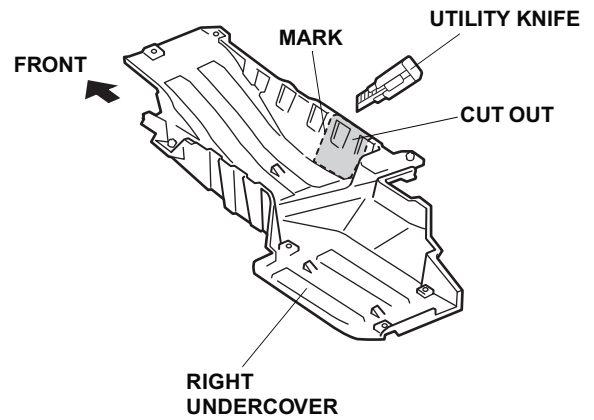

5. Position the brackets at their respective installation positions on the vehicle frame, and install them using two flange bolts for each bracket. Torque the flange bolts to 27 N·m (20 lb-ft).

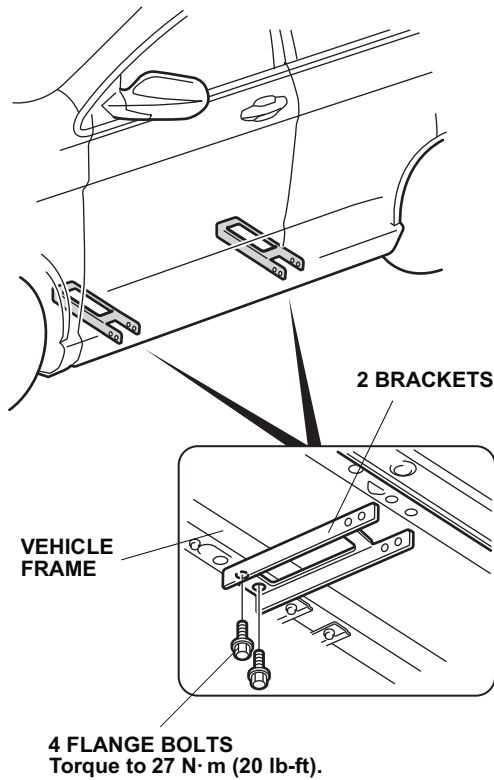

6. Mount the left side step on the left side brackets using four flange bolts and four flange nuts per bracket. Torque the flange bolts to 27 N·m (20 lb-ft).

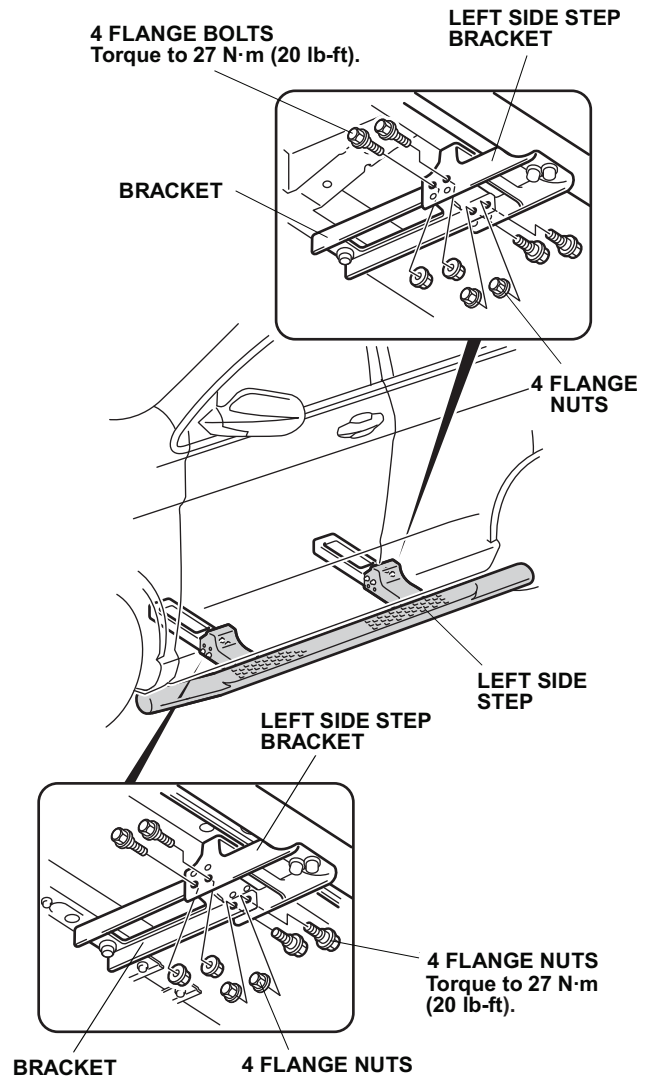

7. Install the left side step brackets to the vehicle frame using two flange bolts per bracket. Torque the flange bolts to 27 N·m (20 lb-ft). On chrome side steps, torque the four flange bolts at the lower part of the left side step to 27 N·m (20 lb-ft).

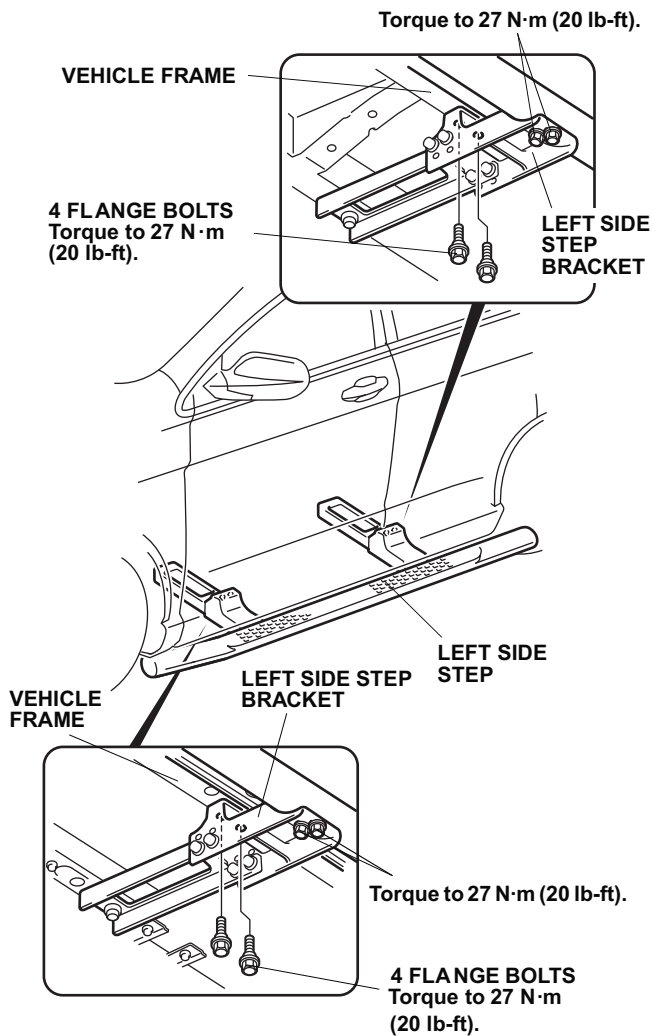

8. Check that all the flange bolts and nuts are torqued properly.
9. Repeat steps 5 thru 8 to install the right side step.
10. Reinstall all removed parts.