



# INSTALLATION INSTRUCTIONS

Accessory

ROOF BOX, SHORT  
P/N 08L20-TA1-100

Application

2009 RIDGELINE

Publications No.

All 40307

Issue Date

AUG 2008

Put this information in the glove box with the vehicle owner's manual.

## PARTS LIST

Roof box

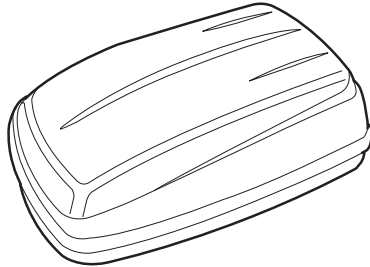

4 Brackets A

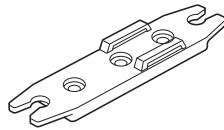

4 Brackets B

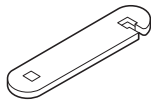

4 Plates

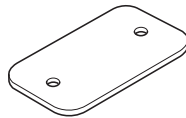

8 Knobs



8 Bolts



8 Washers



2 Straps



Adhesive seals

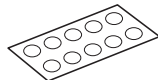

2 Keys



4 Large pads

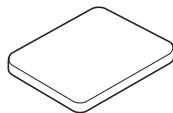

4 Small pads



## SUPPLIES REQUIRED

Isopropyl alcohol

Shop towel

## INSTALLATION

### NOTE:

- Be careful not to damage the roof and other finished surfaces of the body when installing the roof box.
- An optional roof rack (sold separately) is required to attach the roof box.

1. Open the roof box. Attach an adhesive seal over the unused mounting holes along the bottom of the box. The seals will help prevent water from entering the roof box.

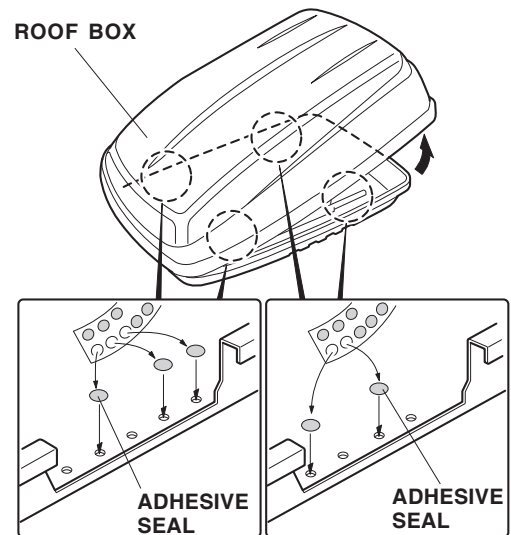

- Using isopropyl alcohol on a shop towel, clean the four brackets B where the small pads will attach. Remove the adhesive backing from the small pads, and attach them to brackets B.

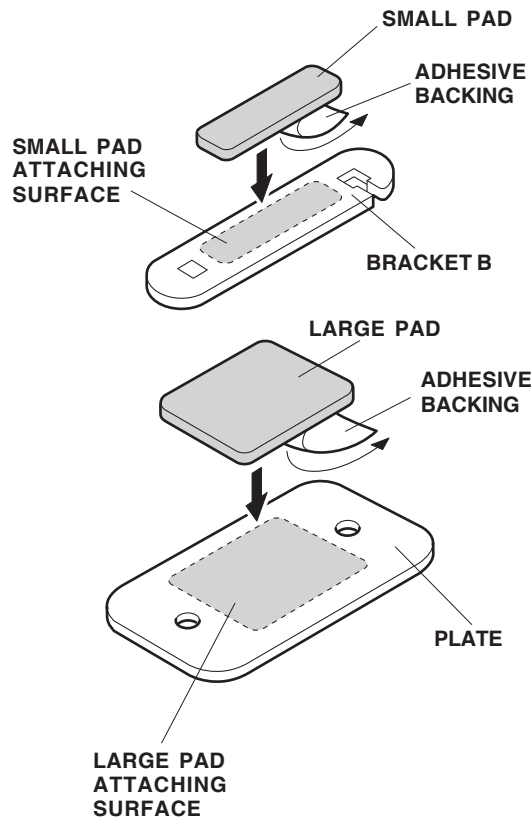

- Using isopropyl alcohol on a shop towel, clean the four plates where the large pads will attach. Remove the adhesive backing from the large pads and attach them to the plates.

- Under the roof box, insert a bolt through bracket B, through the plate and into the predrilled hole in the bottom of the roof box.

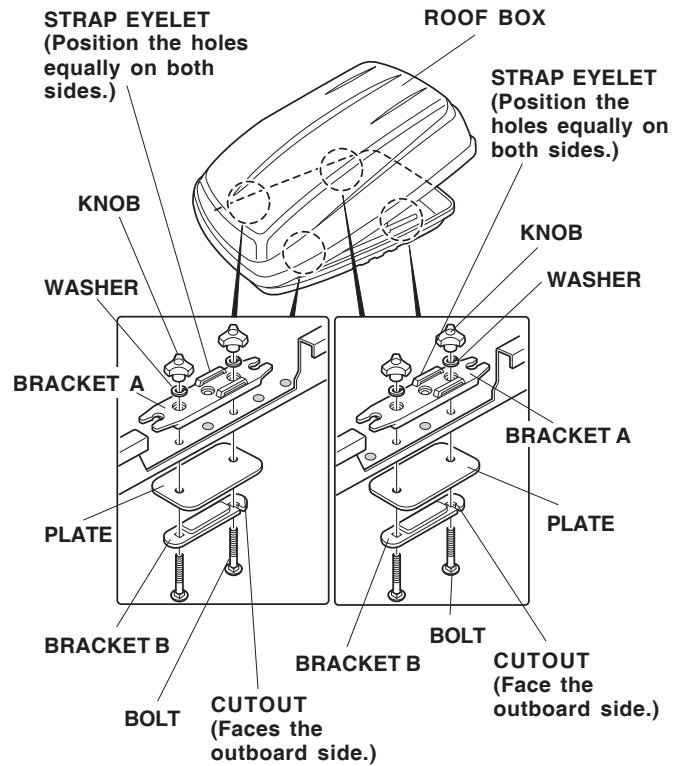

- Fit bracket A over the threads of the bolt where it protrudes through the roof box. Install a washer over the threads, and loosely install a knob. Install a second bolt the same way.

Install bracket B with the cutout facing the outboard side.

- Repeat steps 4 and 5 to install the brackets in the other three positions.

Install brackets A so the strap eyelets on the left and right sides of the box are directly across from each other.

7. With the help of an assistant, carefully place the box on the crossbars. Be aware of the hardware hanging from the bottom of the box.

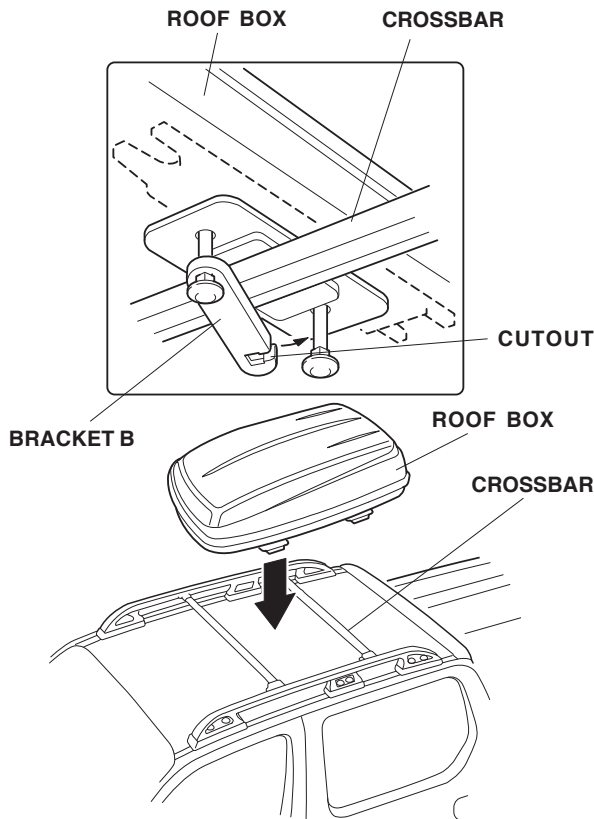

8. Swing the slotted end of bracket B around the bolt, and tighten the knobs. Secure the box this way at all four mounting points.
- If necessary, adjust the distance between the crossbars to line up with the pads on the plates. The distance between the crossbars should be the maximum possible. Additional holes can be drilled in the bottom of the roof box without affecting its stability or load capacity. The minimum bar spread required is 21 5/8 in. for all racks.
  - The roof box should be centered on the crossbars, and parallel to the direction of travel with its flat surface facing the front.

9. Insert the straps through the eyelets on bracket A, and fasten the straps.

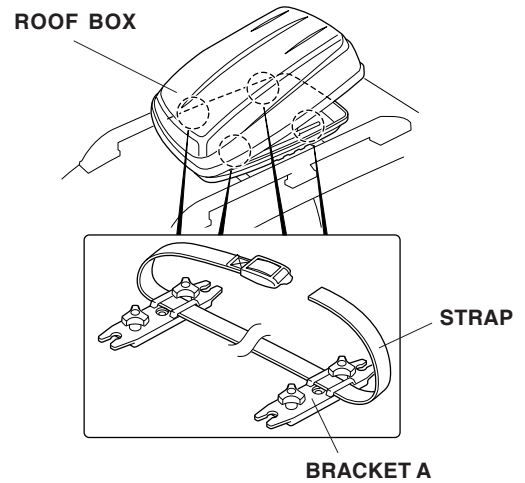

## USE AND CARE

### Unlocking/Locking the Roof Box

**Unlocking:** Locate the key attached to the inside of the roof box. Insert the key into the lock and turn it counterclockwise to unlock. Press the center button, then lift the lid of the roof box.

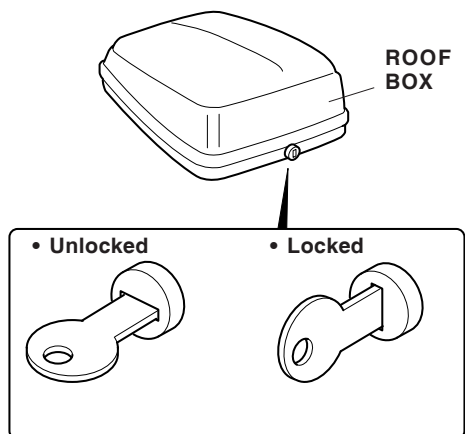

**Locking:** Press down on the lid. There should be an audible click. Be sure the lid is latched by attempting to lift the lid. Turn the key clockwise to lock the roof box. Remove the key while not in use. Be sure the straps are not outside of the roof box.

## LOADING THE ROOF BOX

Load weight equally on both sides to minimize imbalance. Do not overload the roof box, the maximum allowable load is 100 lb (45 kg).

Loads must be secured with the straps to prevent them from sliding. Check the fasteners at regular intervals.