



INSTALLATION INSTRUCTIONS

Accessory

TAILGATE CABANA
P/N 08Z04-SCV-101

Application

2009 ELEMENT

Publications No.

All 40543

Issue Date

OCT 2008

Put this information in the glove box with the vehicle owner's manual.

PARTS LIST

Tailgate Cabana
(with storage bag)

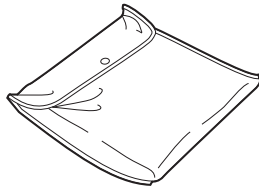

2 Shock cord poles

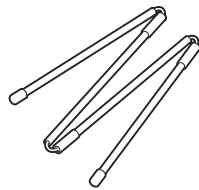

INSTALLATION

⚠ WARNING

Exhaust contains poisonous carbon monoxide gas that can build up to dangerous levels in enclosed areas. Breathing carbon monoxide can cause unconsciousness or death.

Never start or run the vehicle's engine when the tailgate cabana is installed.

NOTE:

- To avoid running the battery down, turn the interior lights off when the tailgate is open.
- The tailgate cabana is designed to provide shade and privacy while the vehicle is parked. It is not intended to be used in the rain, during high winds, or when the vehicle is moving.

1. Remove the tailgate cabana from its storage bag, and drape it over the top of the upper tailgate.

NOTE: If an upper tailgate deflector is installed, position the pockets to the rear of the deflector.

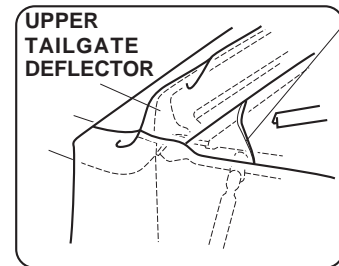
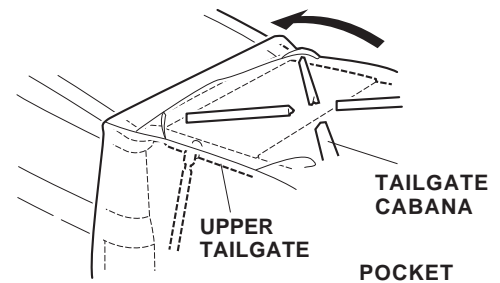

With upper tailgate deflector

2. Open the tailgate, wrap the cabana straps inside, and fasten the buckle. Tighten the strap.

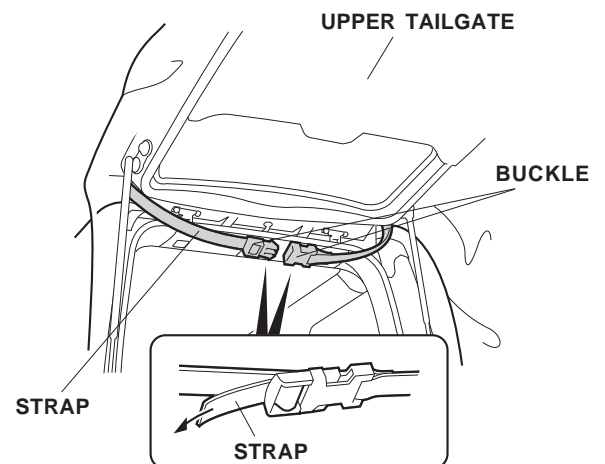

- Assemble the two shock cord poles to make two long poles.

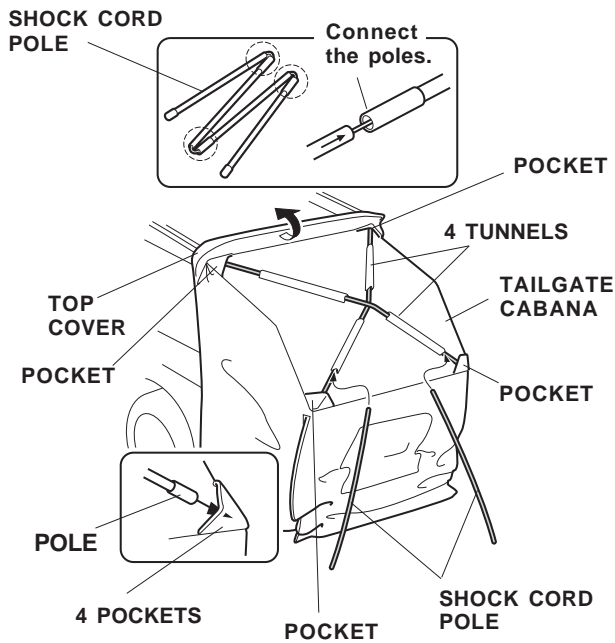

- Lower the tailgate and insert the shock cord poles through the tunnels of the cabana. Place the end of each shock cord pole into the pocket of the cabana.
- Place the top cover of the tailgate cabana forward over the roof.
- Open the tailgate. Attach the corner hooks of the cabana to the rear fender flange.

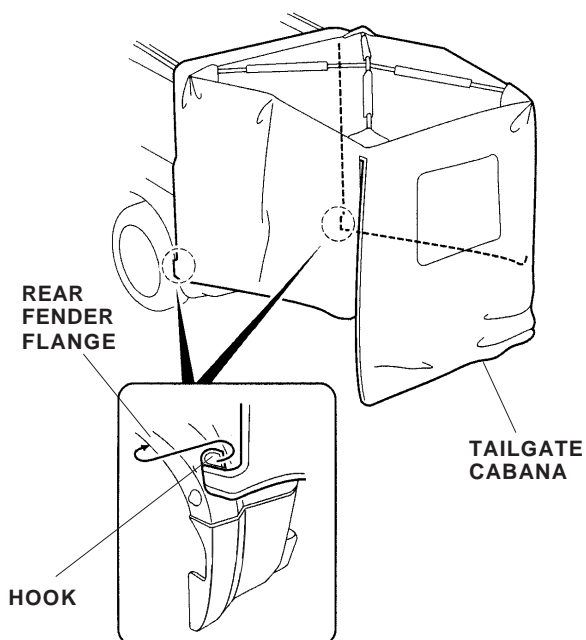

- Lower the zippers to close the cabana.

NOTE: With an upper tailgate deflector installed, the zippers may not close the last 1 to 3 inches.

