



INSTALLATION INSTRUCTIONS

Accessory
**TAILGATE CABANA
POLES**
P/N 08Z04-SCV-100A

Application
2009 ELEMENT

Publications No.
All 40544
Issue Date
OCT 2008

Put this information in the glove box with the vehicle owner's manual.

PARTS LIST

2 Tailgate cabana poles

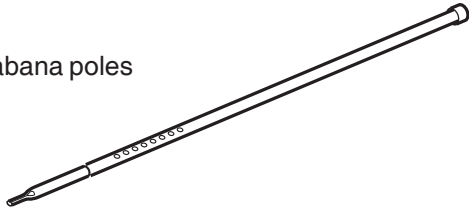

2 Nylon cords with adjusters



4 Stakes

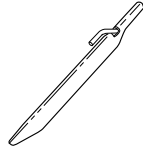

Storage bag

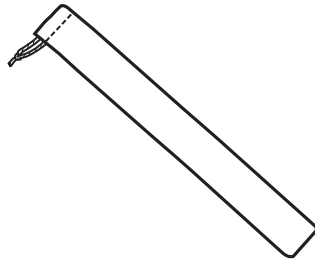

TOOLS AND SUPPLIES REQUIRED

Hammer

INSTALLATION

NOTE:

- Never start or run the vehicle's engine when the tailgate cabana is installed.
- To avoid running the battery down, turn the interior lights off when the tailgate is open.
- Have an assistant hold the tent poles during assembly to prevent any damage.

1. Unzip the tailgate cabana completely.

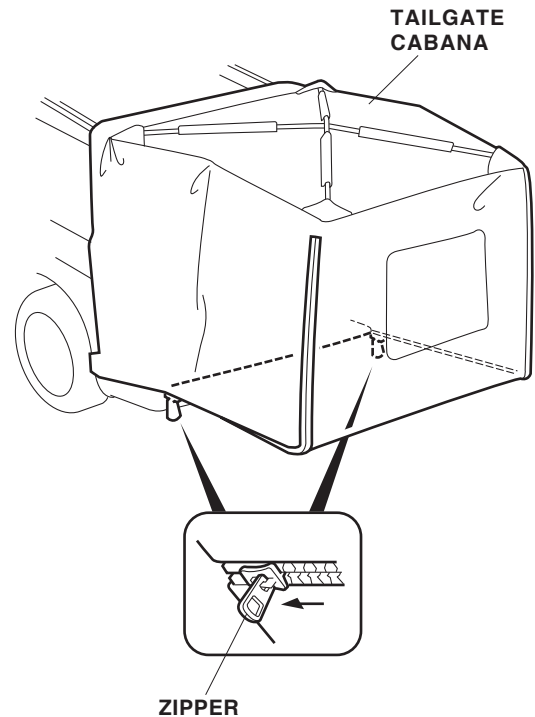

2. Get the nylon cords. Fold the cords in half, and make a loop at the end of each nylon cord opposite the adjusters.

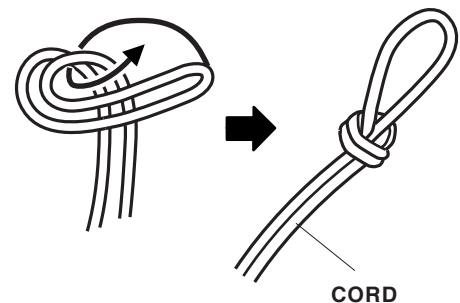

- Open the tailgate cabana, and install a pole into the ring in the cabana. Push in on the pin to adjust the pole height. Make sure the pin is locked in position.

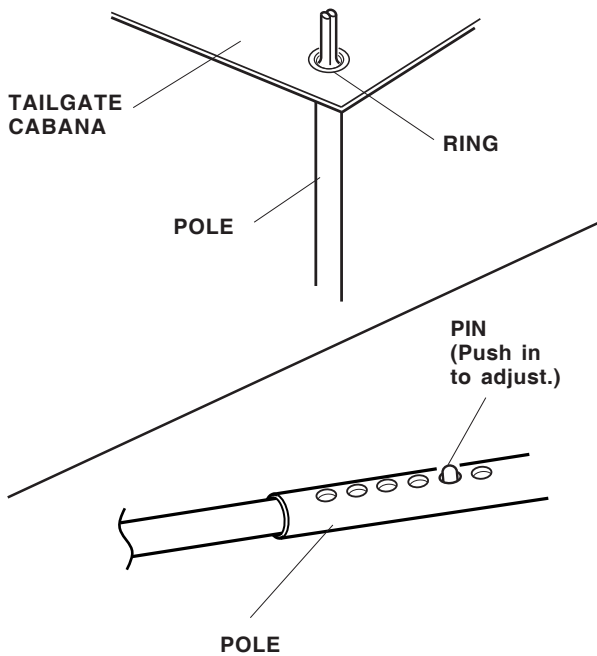

- With an assistant holding the pole, hook the loop in the cord around the the top of the cabana pole.

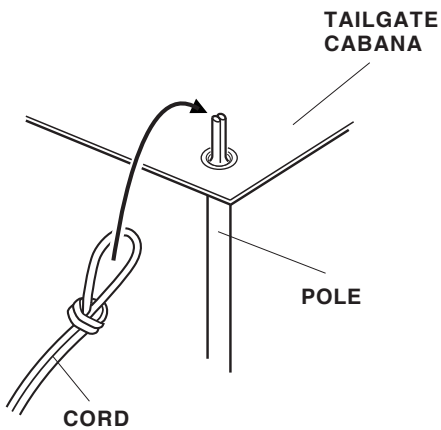

- Get two of the stakes. At a 90° angle from the pole, hammer one stake into the ground in front of the pole at a 45° angle. Install a second stake to the side of the pole using the same angles.

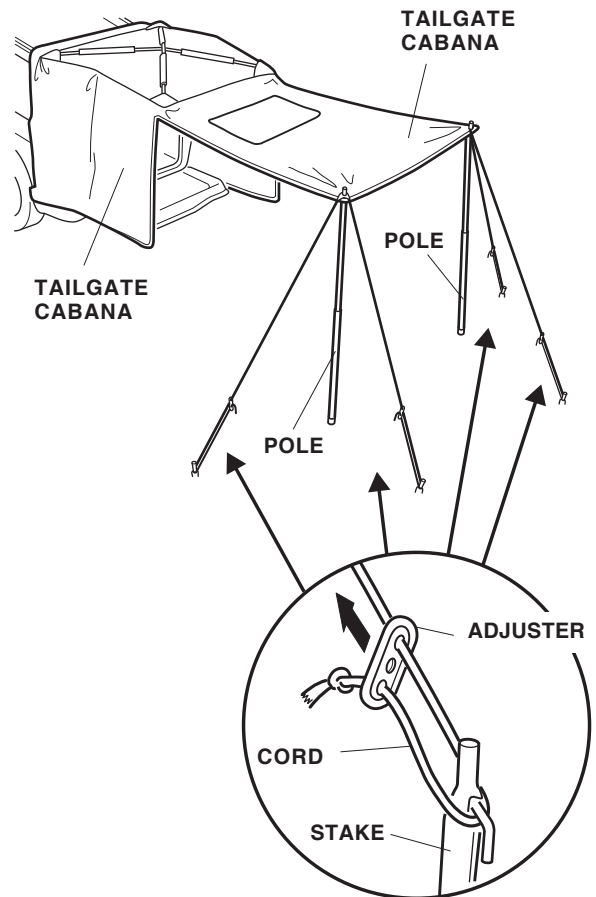
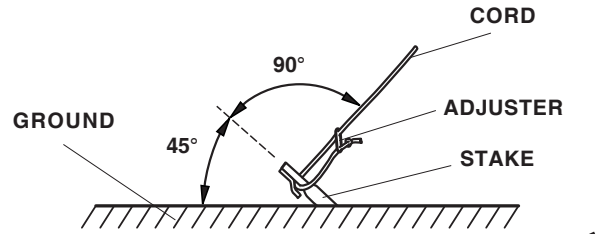

- Move the adjusters up the cord to achieve the proper tension to secure the tailgate cabana.
- Repeat steps 3 thru 6 to attach the other pole. Make sure the stakes are hammered securely into the ground.