



INSTALLATION INSTRUCTIONS

Accessory

ARMREST WITH STORAGE COMPARTMENT
P/N 08U89-SCV-112

Application

2009 ELEMENT
(WITH A/T ONLY)

Publications No.

All 40498

Issue Date

OCT 2008

PARTS LIST

Armrest box

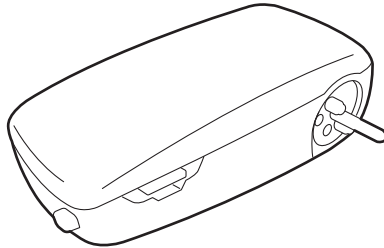

Base



2 Socket bolts



Owner's manual

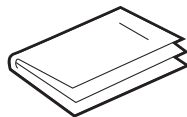

TOOLS AND SUPPLIES REQUIRED

Ratchet

10 mm and 17 mm Sockets

5 mm Hex wrench

Torque wrench

Utility knife

Tape measure

Felt-tip pen

INSTALLATION

NOTE: Be careful not to damage the seat-back when installing the armrest with storage compartment.

If the vehicle is equipped with an armrest, continue with step 1, otherwise go to step 5.

1. Zip open the existing armrest cover on the driver's seat, and pull back the cover as shown.

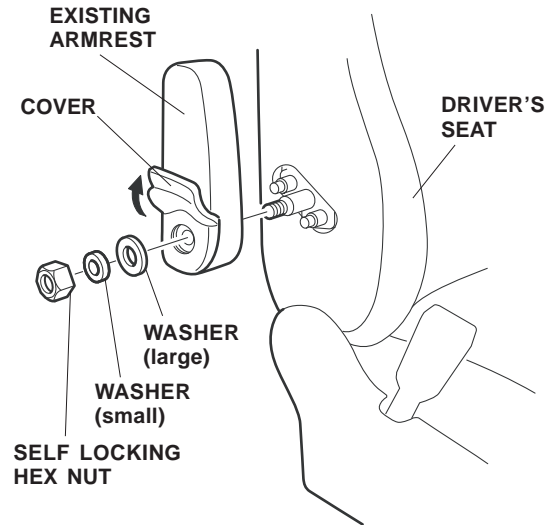

2. Remove the hex nut, small washer, and large washer that secures the existing armrest, and remove the armrest.

3. Release the velcro strap and unzip the seat-back cover, then fold back the seat-back cover and locate the preset in the foam.

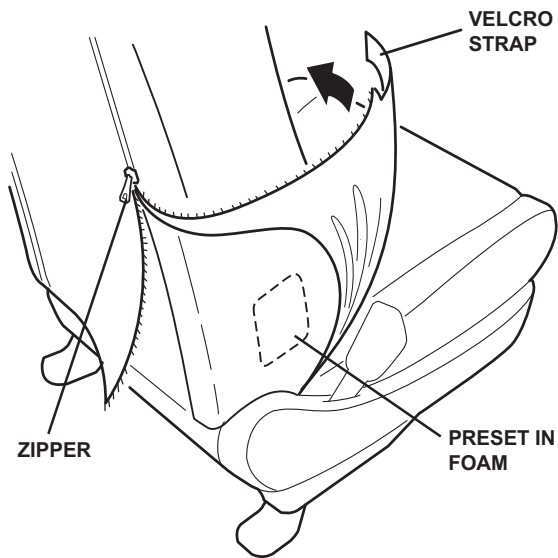

4. Using a utility knife, cut out the foam preset to expose the armrest bracket.

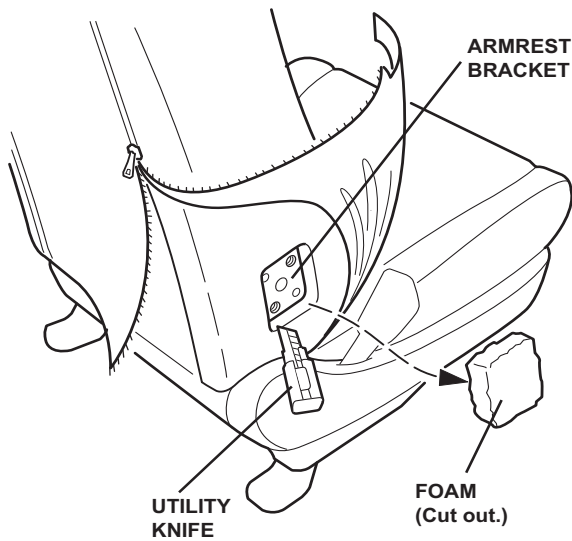

5. Using a felt-tip pen and tape measure, measure and mark the seat-back cover as shown. Push in on the mark, and confirm that the mark is centered over the hole in the seat base.

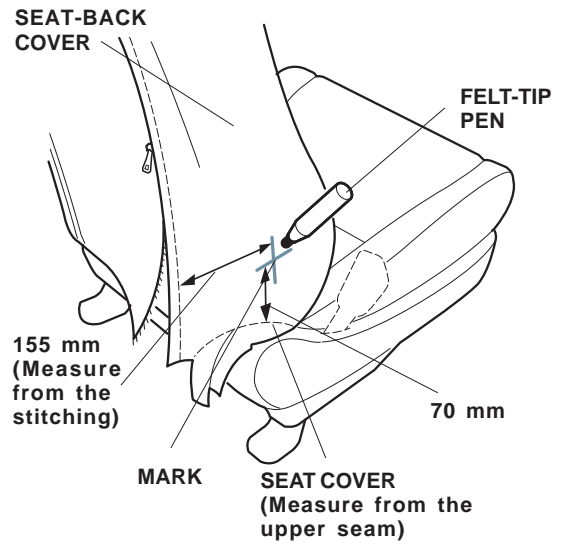

6. Using a utility knife, make two 65 mm (2 1/2 in.) cuts in the seat-back cover to expose the seat base.

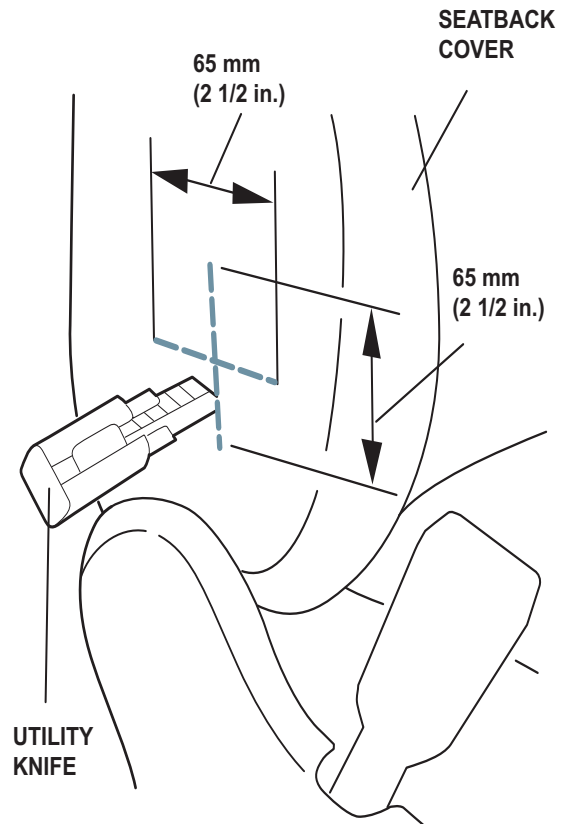

7. Get the new base from the kit, and position it on the seat's pin base. Install the two socket bolts. Torque the socket bolts to 10-12 N·m (7-9 lbf·ft).

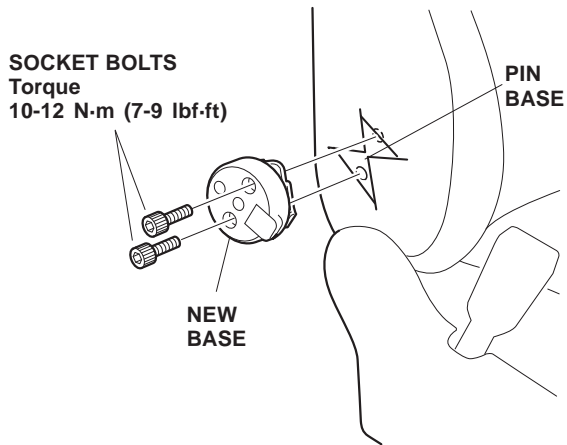

8. Insert the armrest into the holes in the base and push on it until it clicks into position. The white recessed portion of the push knob should be visible.

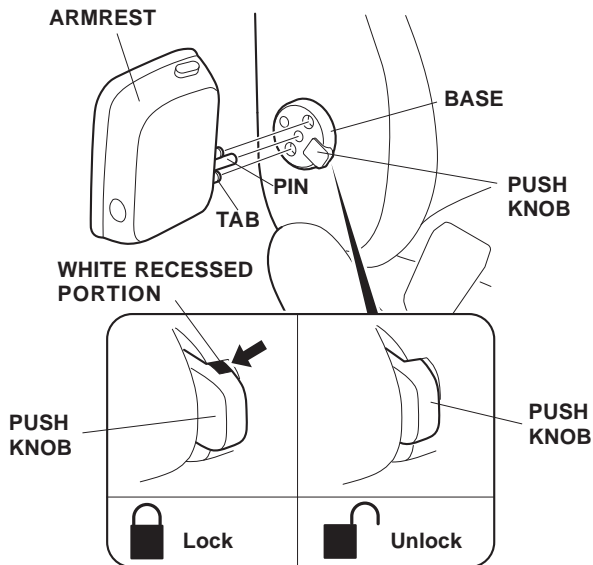

9. Check that the armrest operates properly by moving it up and down with your hand.
10. To release the armrest, press on the push knob and pull out on the armrest.
11. Put the armrest owner's manual in the glove box.