



INSTALLATION INSTRUCTIONS

Accessory

CIGARETTE LIGHTER
P/N 08U96-S9A-101

Application

2009 CIVIC
2- AND 4-DOOR

Publications No.

All 40111

Issue Date

AUG 2008

PARTS LIST

Cigarette lighter

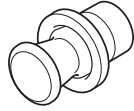

Socket

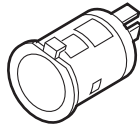

Ring



Fuse label

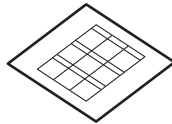

TOOLS AND SUPPLIES REQUIRED

Shop towel

Small flat-tip screwdriver

INSTALLATION

Customer Information: The information in this installation instruction is intended for use only by skilled technicians who have the proper tools, equipment, and training to correctly and safely add equipment to your vehicle. These procedures should not be attempted by "do-it-yourselfers."

1. Make sure you have the anti-theft code for the audio unit, then write down the radio station presets.
2. Disconnect the negative cable from the battery.

3. Cover the shift lever with a shop towel to protect it from damage.

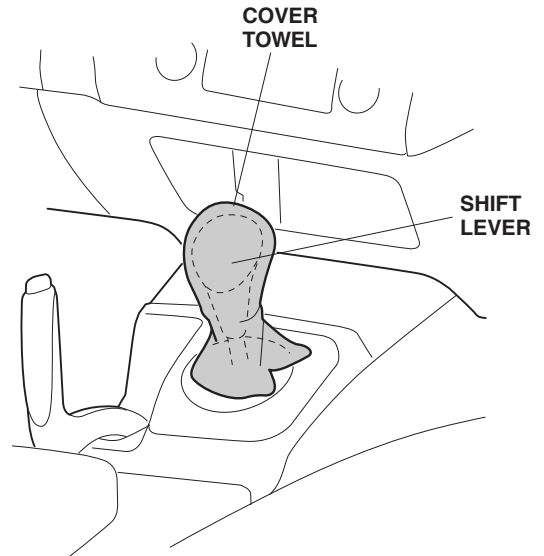

4. Shift to S or 2. Remove the lid from the dashboard center lower cover (four retaining tabs).

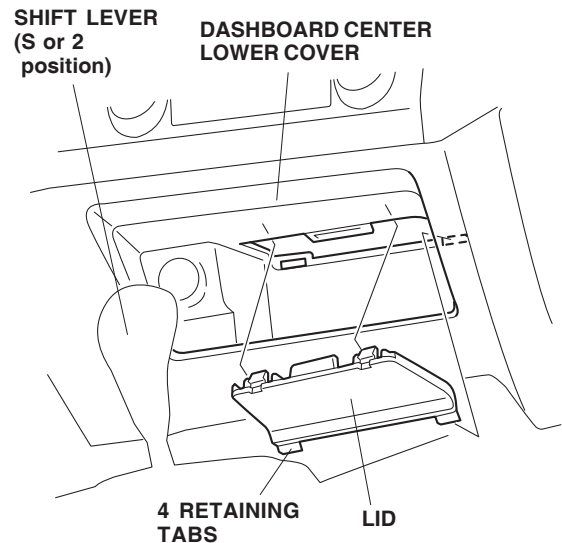

- Open the accessory socket cover. Using a shop towel around a small flat-tip screwdriver, gently pry on the accessory socket to pop it out. Disconnect the vehicle 2-pin connector from the accessory socket.

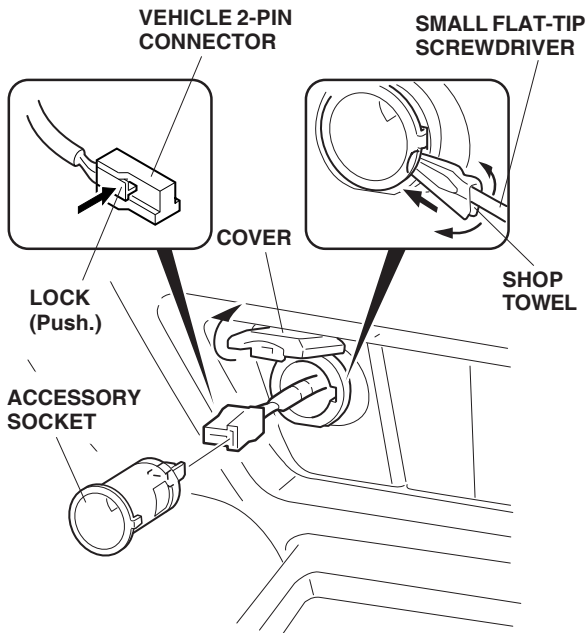

- Pull out the accessory socket case from the dashboard center lower cover.

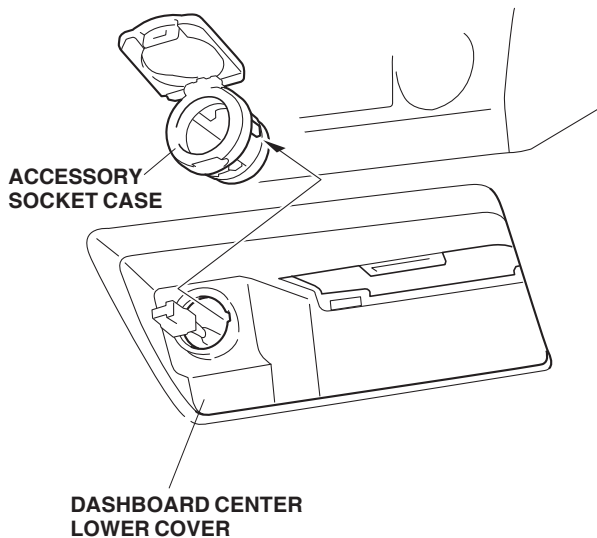

- Slide the ring into the hole in the dashboard center lower cover in the direction shown.

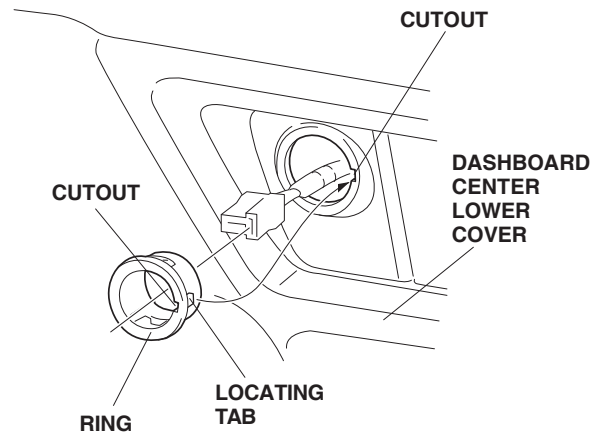

- Connect the vehicle 2-pin connector to the socket.

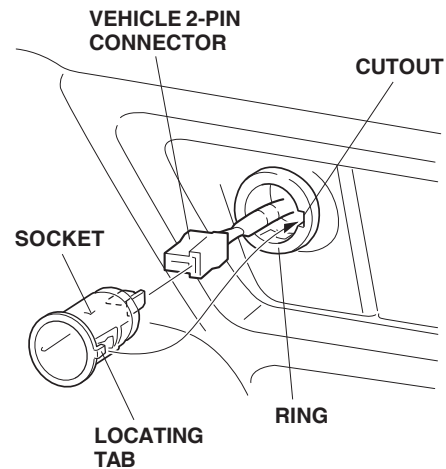

- Align the locating tab on the socket with the cutout in the ring, and slide the socket into the ring.

10. Push the cigarette lighter into the socket.

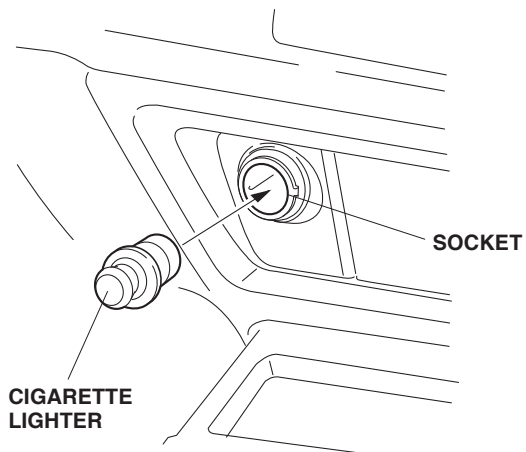

11. Attach the 15A fuse label to the No. 29 slot to the left kick panel.

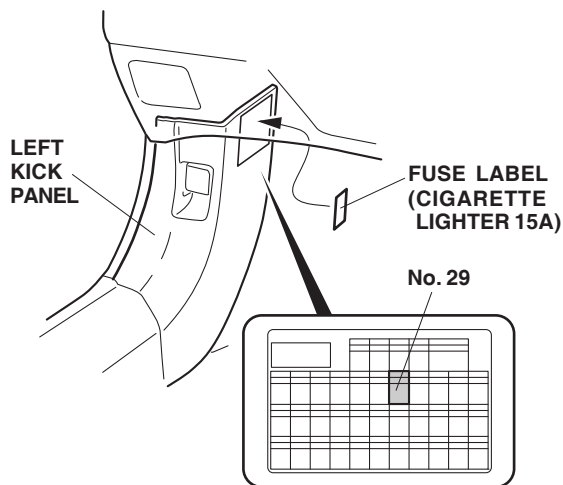

12. Reinstall the lid in the dashboard center lower cover.
13. Reconnect the negative cable to the battery.
14. Enter the customer's audio unit anti-theft code, and reset the radio station presets.
15. Reset the clock.
16. Test the cigarette lighter.
17. Initialize the auto up/down function of the front windows.