



INSTALLATION INSTRUCTIONS

Accessory

REAR UNDER SPOILER

Application

2009 CIVIC
4-DOOR Si

Publications No.

All 40261

Issue Date

SEP 2008

PARTS LIST

Rear under spoiler

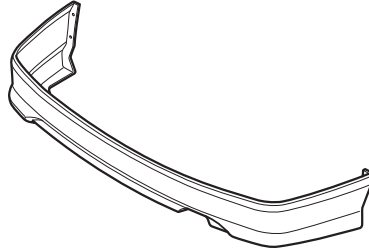

4 Square head bolts

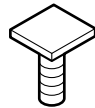

4 Flange nuts



4 Flange bolts



2 Black flange bolts

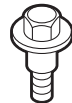

2 Clip nuts



4 Spacers



TOOLS REQUIRED

Phillips screwdriver

Flat-tip screwdriver

Ratchet

10 mm socket

Drill

3 mm and 10 mm Drill bits

Clip remover

Pushpin

Blanket

Masking tape

Isopropyl alcohol

Shop towel

Eye protection (face shield, safety goggles, etc.)

Hacksaw

INSTALLATION

Customer Information: The information in this installation instruction is intended for use only by skilled technicians who have the proper tools, equipment, and training to correctly and safely add equipment to your vehicle. These procedures should not be attempted by "do-it-yourselfers."

NOTE:

- Be careful not to damage the rear bumper and body paint finish.
- This rear under spoiler kit should be installed only if the ambient air temperature is 60°F (15°C) or above.
- To allow the adhesive to cure, do not wash the vehicle for 24 hours.

1. Remove the rear bumper:

- Remove the six self-tapping screws from the rear bumper (three on each side).

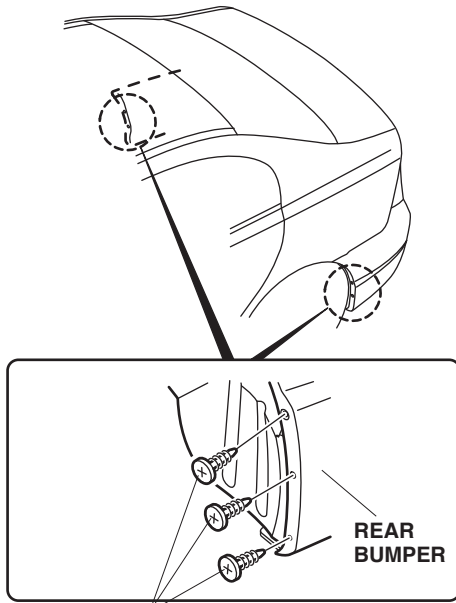

SELF-TAPPING SCREWS (Reuse.)

- Remove the two bolts, two clips, and two self-tapping screws. If equipped, unplug the backup sensor connectors.

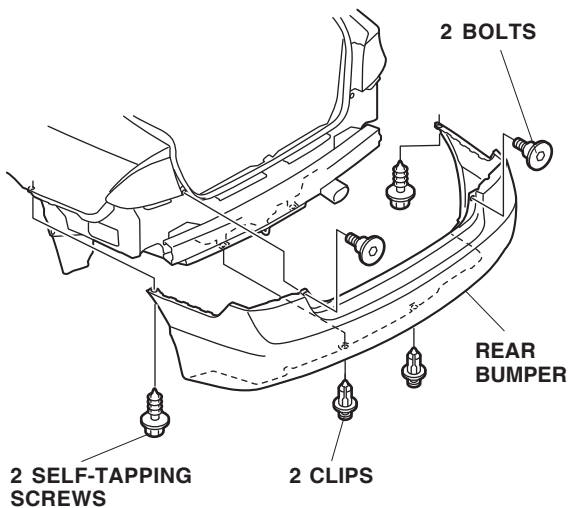

- With the help of an assistant, remove the rear bumper and place on a blanket.

2. On the inside of the bumper, locate the 10 preset marks. Using a pushpin, pierce a hole through the bumper at each preset mark.

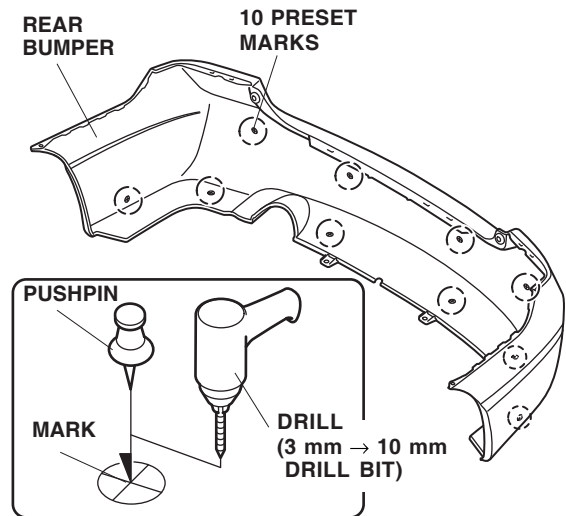

3. While wearing eye protection, drill a 10 mm hole through each pierced mark. First drill with a 3 mm drill bit, and finish with a 10 mm drill bit. Remove any burrs from the edges of the holes.

- On the inside of the rear bumper at the exhaust opening, locate the two preset marks. Using a pushpin, pierce the rear bumper at each mark.

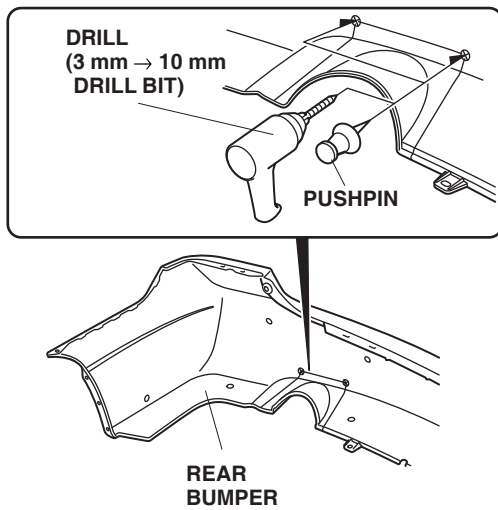

- While wearing eye protection, drill a 10 mm hole at each pierced mark on the rear bumper. First drill a 3 mm drill bit, and finish with a 10 mm drill bit.
- Using a hacksaw blade, cut out the rear bumper along the lines shown.

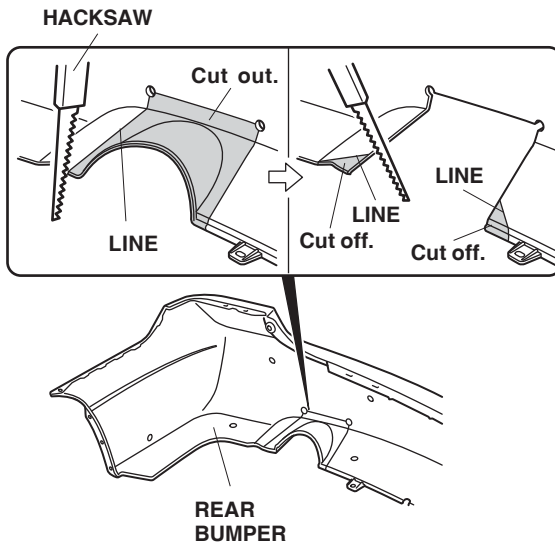

- Using isopropyl alcohol on a shop towel, clean the rear under spoiler where the spacers will attach.

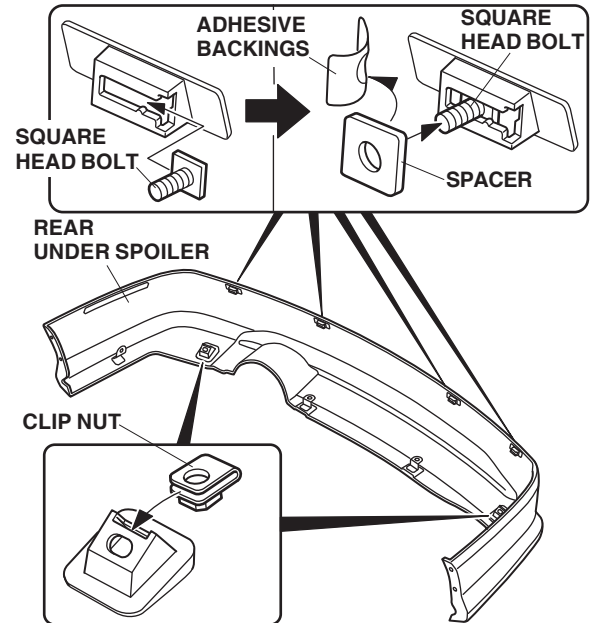

- Install one square head bolt into each of the four slots in the rear under spoiler. Remove the adhesive backing from the spacer, and attach one spacer over each square head bolt.
- Along the bottom of the rear under spoiler, install one clip nut into each slot.
- Peel back one inch from the end of the two adhesive backings shown, and attach them to the front of the rear under spoiler with masking tape.

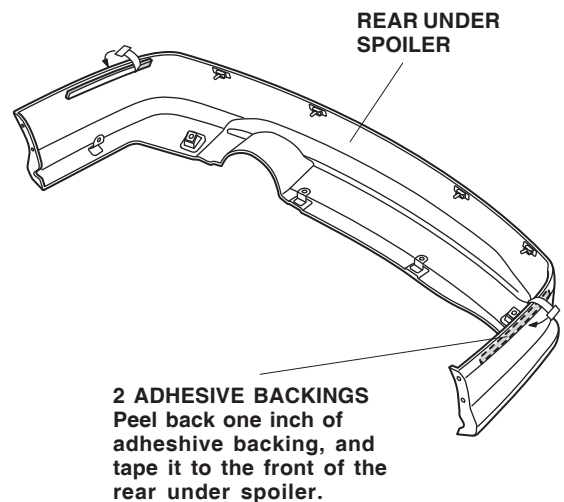

11. Using isopropyl alcohol on a shop towel, clean the rear bumper where the rear under spoiler will attach.

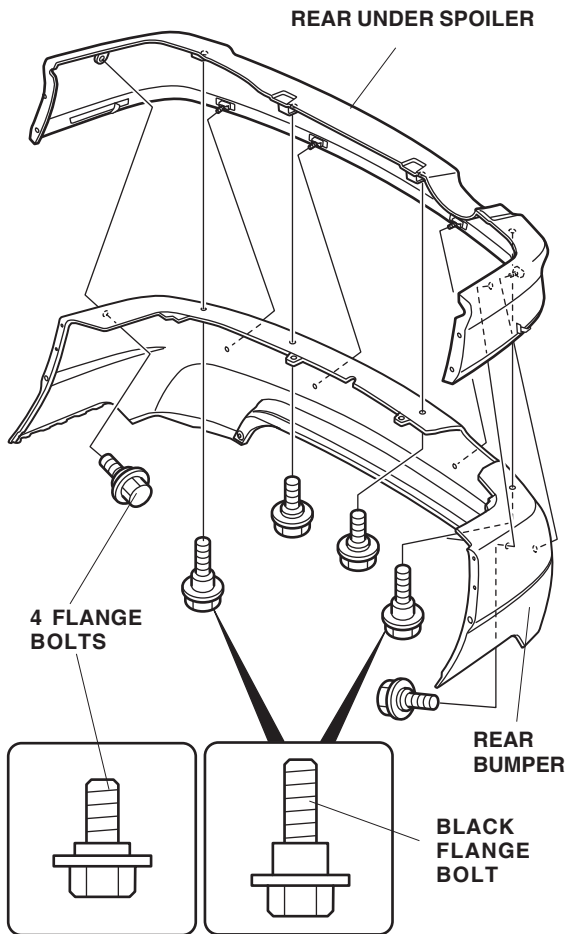

12. Position the rear under spoiler on the rear bumper, and install the six flange bolts. Make sure to install the two black flange bolts at the locations shown.
13. Install four flange nuts to the square head bolts you installed in step 8. Torque the flange nuts to 2 N·m (1.5 lb-ft).

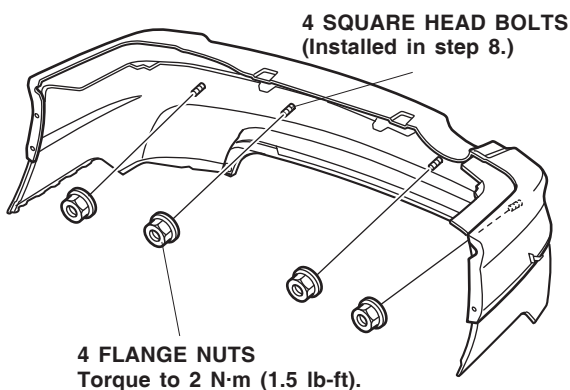

14. Reinstall the rear bumper with spoiler.

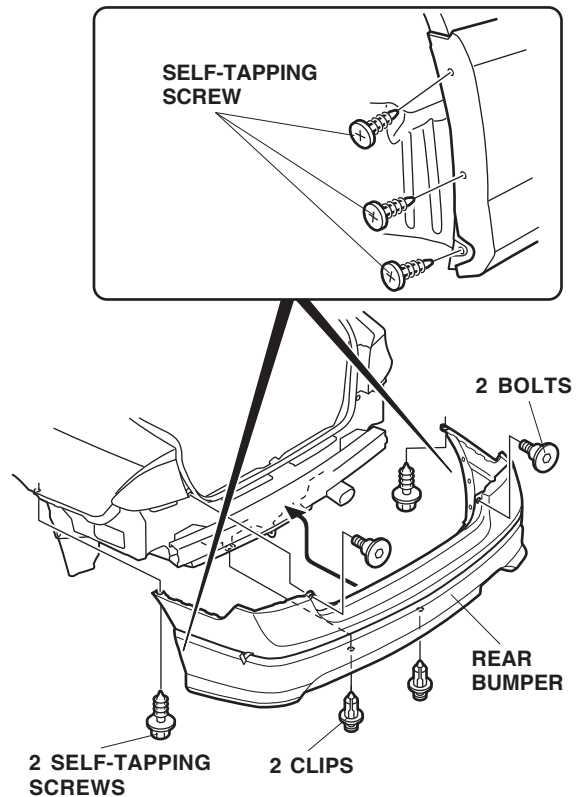

15. While applying light pressure to the rear under spoiler, slowly and carefully remove the adhesive backings. After removing, hold the rear under spoiler firmly against the rear bumper with the palm of your hand for 30 seconds.

