



# INSTALLATION INSTRUCTIONS

Accessory

MOONROOF VISOR  
P/N 08R01-SNA-100

Application

2009 CIVIC  
4-DOOR

Publications No.

All 40134

Issue Date

AUG 2008

Put this information in the glove box with the vehicle owner's manual.

## PARTS LIST

Moonroof visor

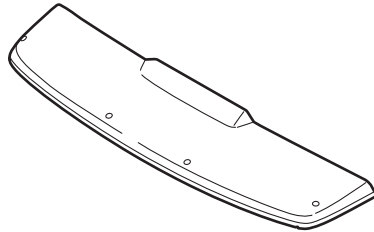

2 Front brackets

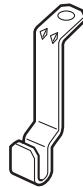

2 Side brackets

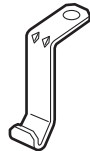

4 Nuts



4 Protective tapes



4 Screws



## TOOLS AND SUPPLIES REQUIRED

10 mm Combination wrench

#2 Phillips screwdriver

Masking tape

Isopropyl alcohol

Shop towels

Felt-tip pen

Tape measure

Torque wrench

## INSTALLATION

1. Clean the roof area to be covered, and wax the area with a high-quality paste wax.
2. Open the moonroof.
3. Roll up two shop towels, and insert them between the roof panel and air deflector to lower the air deflector. Take care not to damage the air deflector.

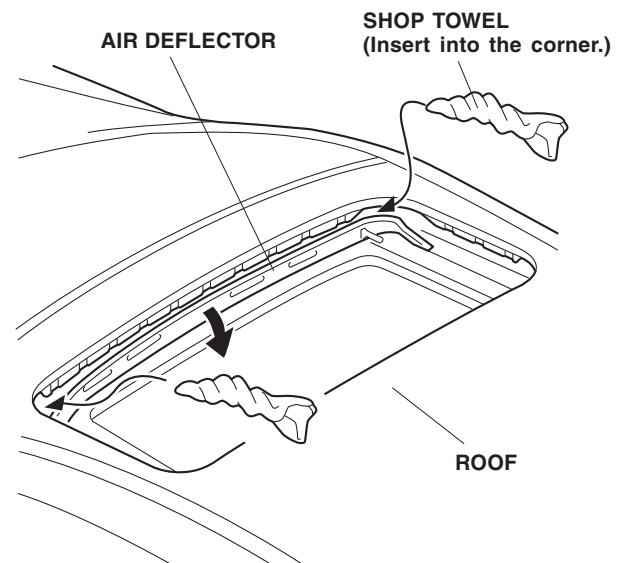

- Using isopropyl alcohol on a shop towel, clean the fourth indentation roof area and the inside edge of the moonroof opening where the protective tapes will be attached.

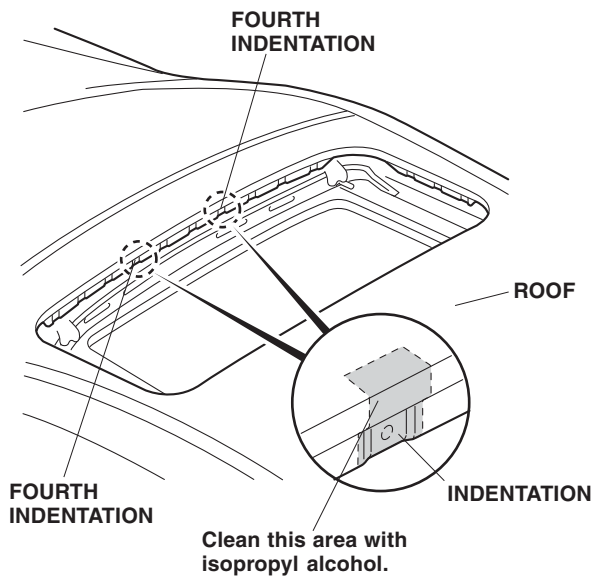

- Remove the adhesive backing from one of the protective tapes. Starting at the bottom edge of the tape, wrap 4 mm (0.2 in.) of the protective tape around the lip of the moonroof opening to cover one of the located indentations; continue upward with the tape around the top of the roof panel.

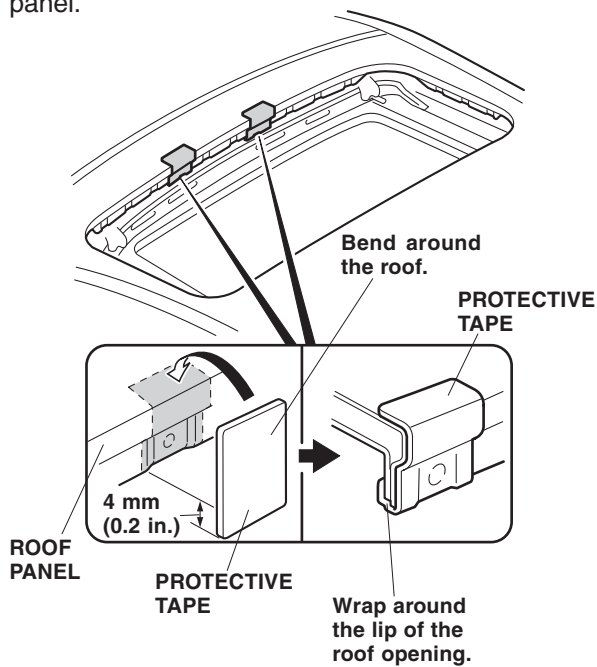

- Using the same procedure, attach the other protective tapes to the roof at the other located indentations.

- Locate the panel joint on the right side of the moonroof opening. Measure 98 mm (3.9 in.) to the front of the car, and make a mark on the roof. Repeat on the other side of the moonroof opening.

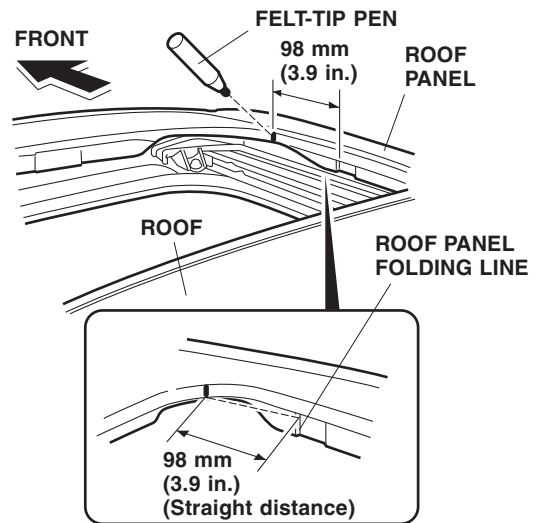

- Using isopropyl alcohol on a shop towel, clean the roof at each of the two marks you've made but don't wipe off the marks.
- Remove the adhesive backing from the two protective tapes, and attach one to the roof at each of the two marks you made. Wrap 4 mm (0.2 in.) of the protective tape around the lip of the moonroof opening.

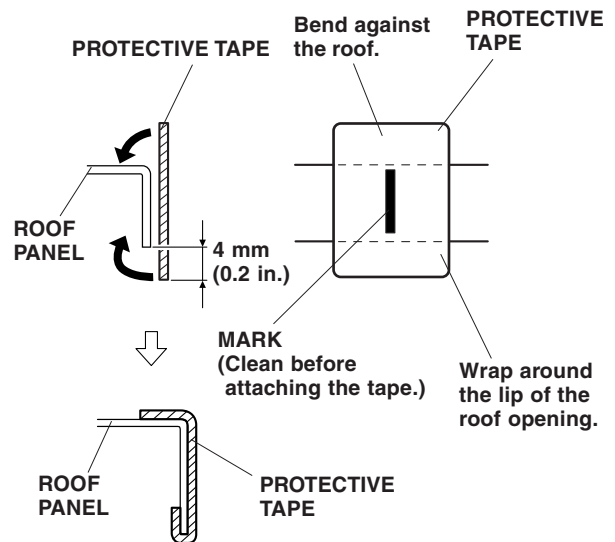

- Place the two side brackets into position over the protective tape and around the lip of the roof opening, and secure them into position with a piece of masking tape.

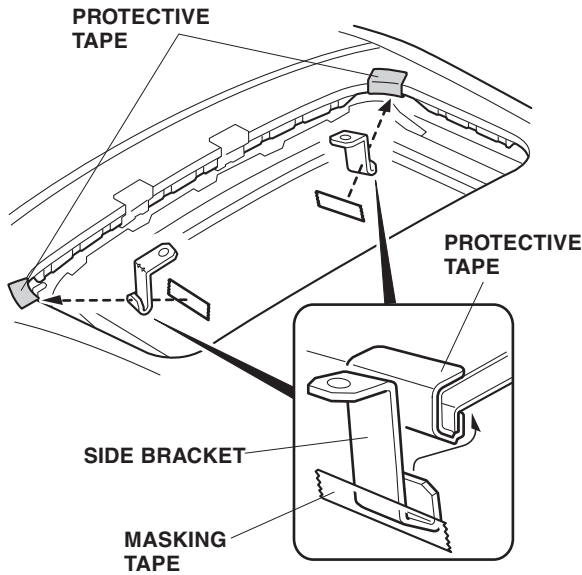

- Place the two front brackets into position over the protective tape and around the lip of the roof opening, and tape them into position with a piece of masking tape. Make sure to align the lower end of the front brackets with the indentation in the lip.

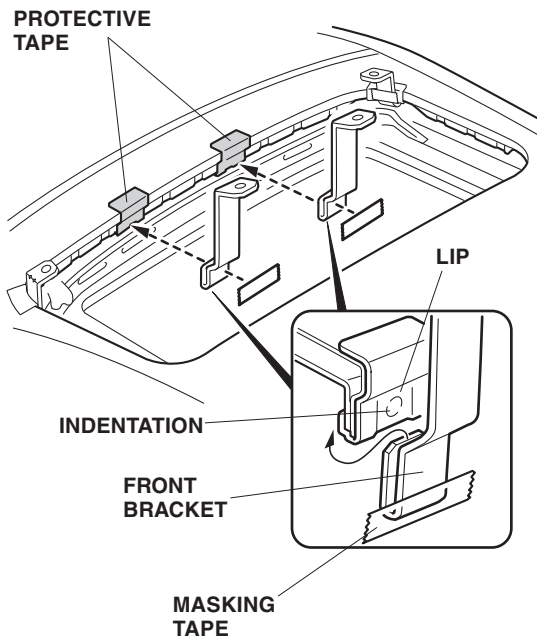

- Set the moonroof visor on the vehicle roof in front of the moonroof opening, and adjust its position so the holes in the visor are aligned with the front bracket holes. Install two screws and nuts loosely onto the front brackets.

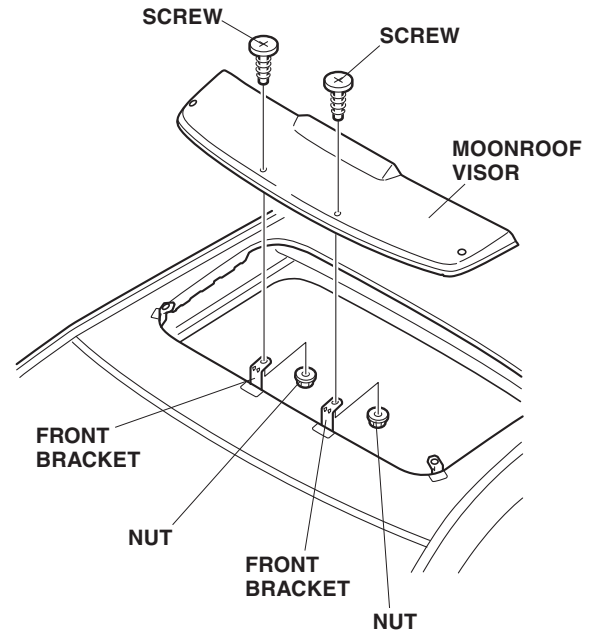

- Insert a screw through the two remaining holes on the top of the visor, then loosely install the nuts as shown.

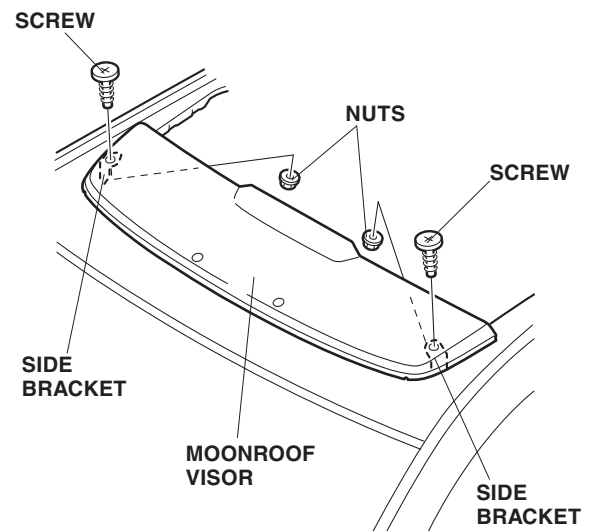

- Position the moonroof visor with equal spacing on all sides. Check that the rubber seal is not twisted or rolled under the visor.

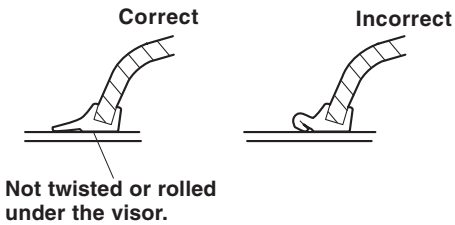
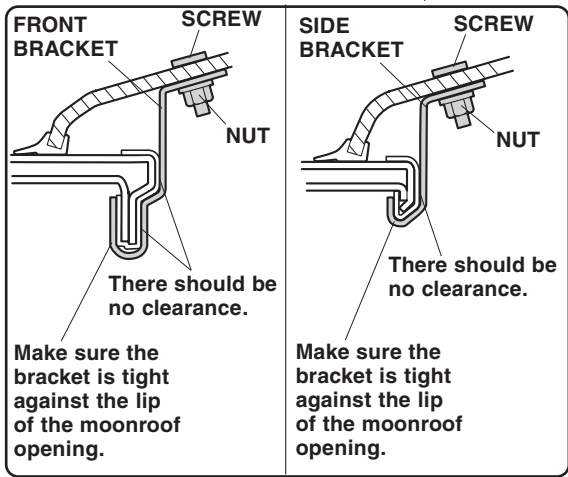
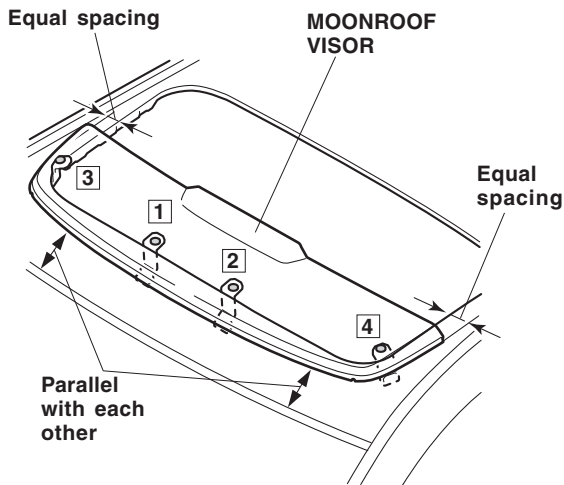

- Tighten the nuts and screws in the order shown, alternating between sides. To prevent damage to the moonroof visor and the resin nuts, do not overtighten the screws. Tightening torque: 2 N·m (0.2 kgf·m, 1.5 lb-ft)
- Remove the shop towels and masking tape.

## CARE OF THE MOONROOF VISOR

- To avoid damaging the surface, never use ammonia-based cleaners or solvents to clean the moonroof visor.
- Clean with a solution of mild dishwashing soap and water using a soft cloth or chamois.
- To remove fine scratches and restore the original luster, use Meguiar's Mirror Glaze plastic cleaner and polish or an equivalent high-quality plastic cleaner.