



INSTALLATION INSTRUCTIONS

Accessory

LUGGAGE BASKET
P/N 08L04-S9V-100

Application

2008 RIDGELINE

Publications No.

All 36599

Issue Date

MAY 2007

Put this information in the glove box with the vehicle owner's manual.

PARTS LIST

2 Frames A

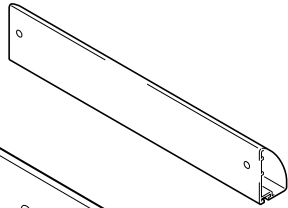

2 Frames B

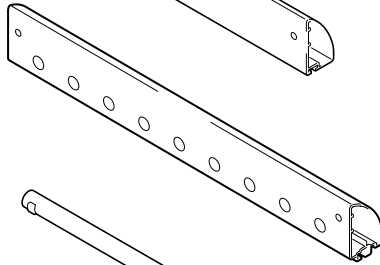

9 Pipes

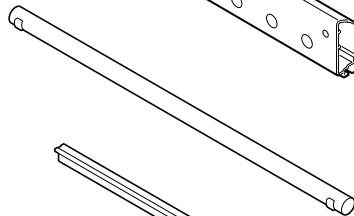

Flap



L Brackets

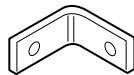

4 Bracket covers A



4 Bracket covers B



4 Brackets A

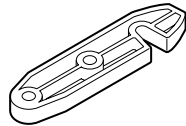

8 Bolts



8 Screws

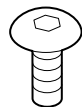

8 Self-tapping screws

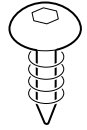

8 Nuts



8 Washers



Hex wrench

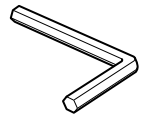

4 Brackets B

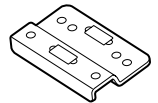

8 Square nuts



8 Socket bolts



TOOLS REQUIRED

Phillips screwdriver

10 mm Combination wrench

INSTALLATION

NOTE:

- Be careful not to damage the roof and other finished surfaces of the body when installing the roof basket.
- Be careful before entering automatic car washes. Compare the vehicle height limit of the automatic car wash and the height of the vehicle.
- The maximum load capacity for this product is 50 kg (110 lb); approximate product weight is 5 kg (12 lbs).
- An optional roof rack (sold separately) is required to install the roof basket.

1. Insert the nine pipes into frame B, by pressing down on the button on the end of each pipe, and pushing the end into the hole in frame B. Repeat on the other side.

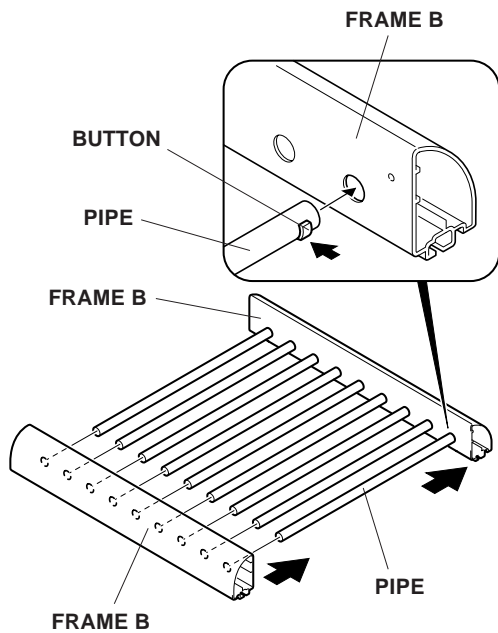

2. Slide one flap into the groove of one frame A. This frame will be the front of the basket.

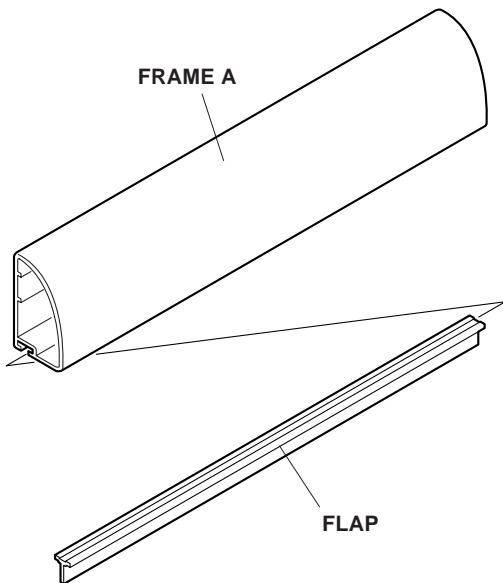

3. Attach one L bracket on each end of the frame A using one screw for each bracket.

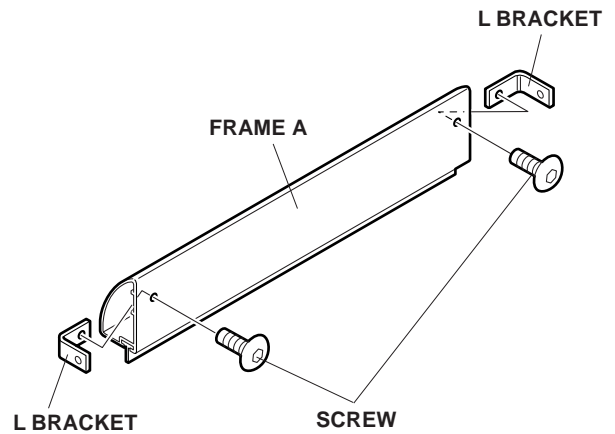

4. Install L brackets on the other frame A.
5. Attach frame A to frame B by sliding the L brackets into frame B and installing two screws.

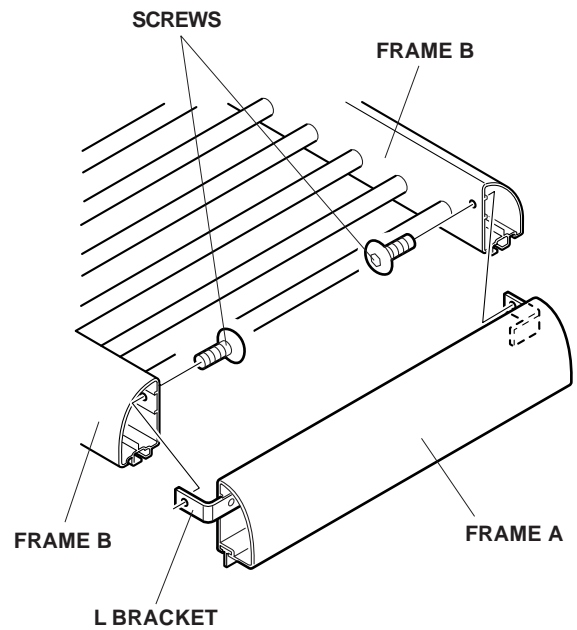

6. Install the remaining frame A to frame B the same way.

- Slide four square nuts into frame B through the groove shown. Repeat on the other frame B.

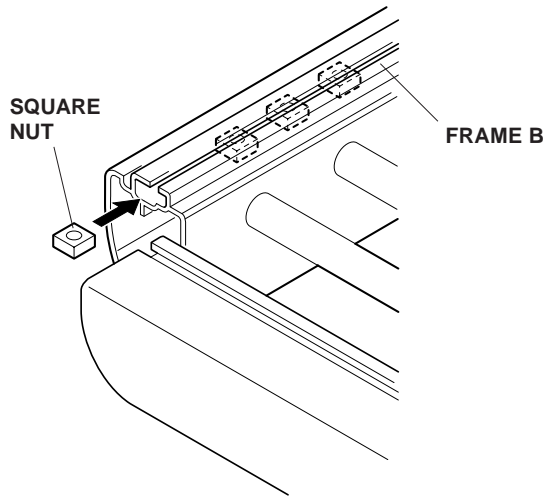

- Position four L bracket covers A over the corners of the frame, then install four L bracket covers B. Secure the covers with self-tapping screws.

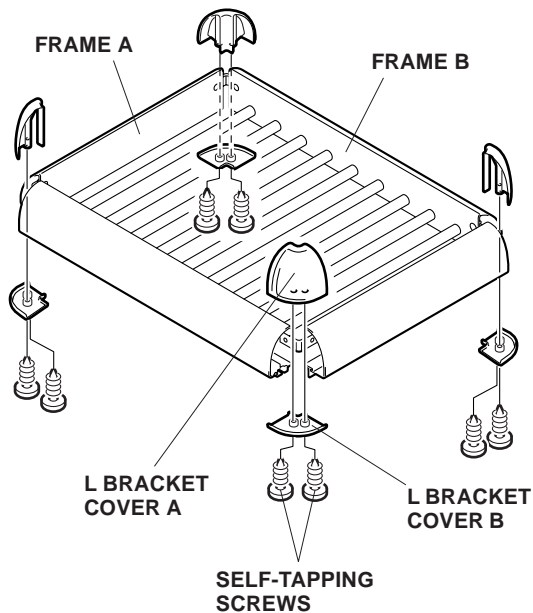

- Position four brackets B to frame B at the measurement shown, and install two socket bolts into the two square nuts for each bracket B.

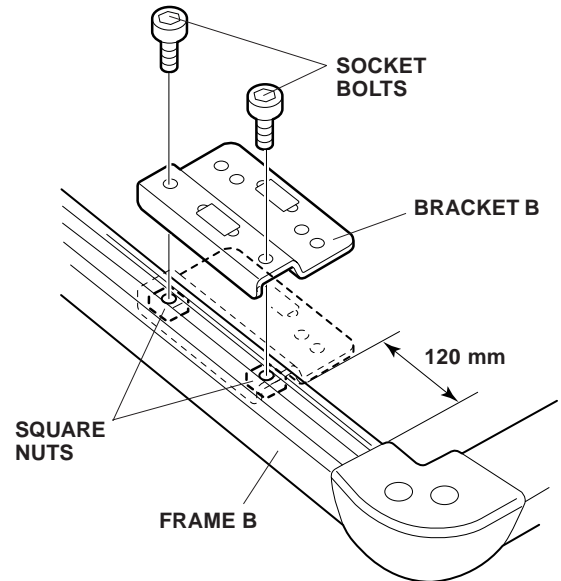

- Attach the brackets A to the four brackets B, using two bolts, two washers and two nuts for each bracket A. Do not tighten the bolts yet.

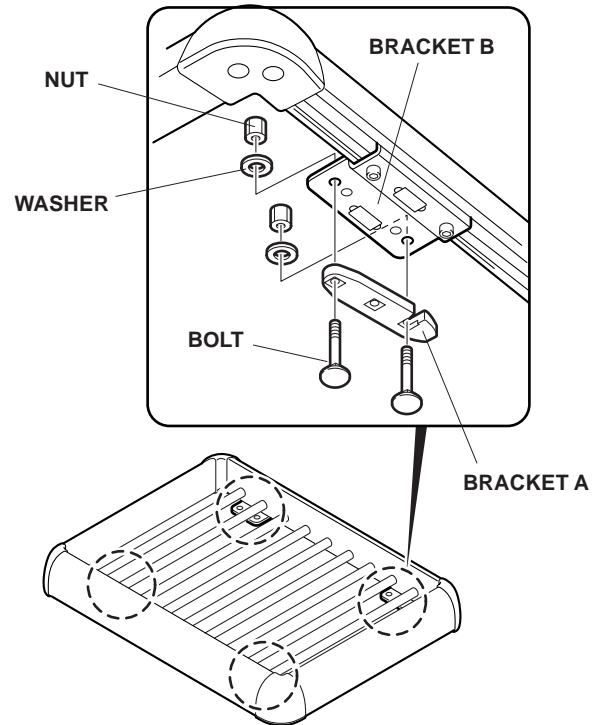

11. Position the roof basket on the roof rack, with the flap from frame A facing forward. Attach the basket to the cross bars by sliding bracket A around the crossbar and tightening the nuts. Tighten the nuts evenly.

