



INSTALLATION INSTRUCTIONS

Accessory
SECURITY SYSTEM

Application
2008 PILOT

Publications No.
All 37126
Issue Date
JUN 2007

PARTS LIST

Security System Kit (sold separately)
P/N 08E51-EP4-101

Security system control unit

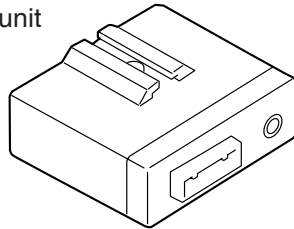

LED

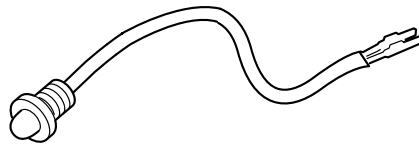

Push nut



2-pin connector (for LED)

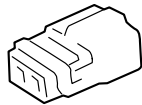

Microphone

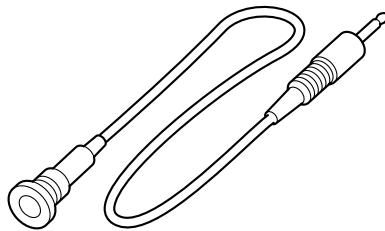

Window decal

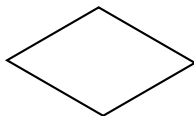

Accessory user's
Information Manual

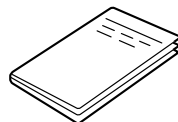

Attachment Kit (sold separately)
P/N 08E55-S9V-100A

Security system harness

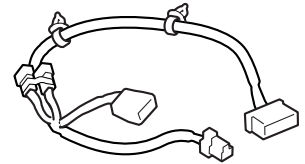

Control unit bracket

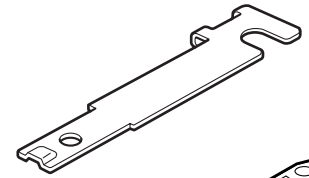

8 Wire ties

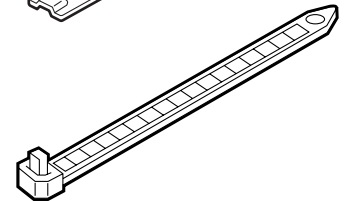

Wire tie with connector holder

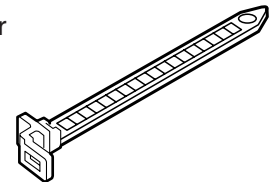

Holder bracket

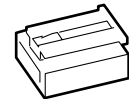

2 EPT sealers

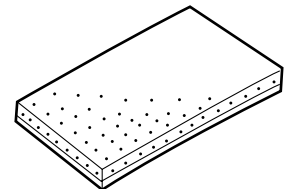

Cushion tape

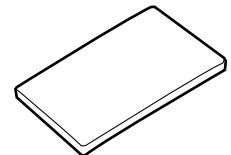

Flange bolt

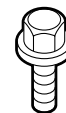

Small wire tie

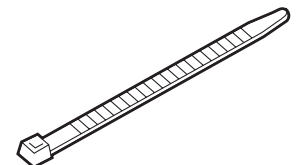

TOOLS AND SUPPLIES REQUIRED

Phillips screwdriver
Flat-tip screwdriver
8 mm and 10 mm Combination wrenches
Ratchet
10 mm Socket
Diagonal cutters
Punch
Felt-tip pen
Isopropyl alcohol
Shop towel
Drill
3 mm, 5.5 mm and 8 mm Drill bits
Tape measure
Eye protection (face shield, safety goggles, etc.)

Illustration of Security System installed on the Vehicle

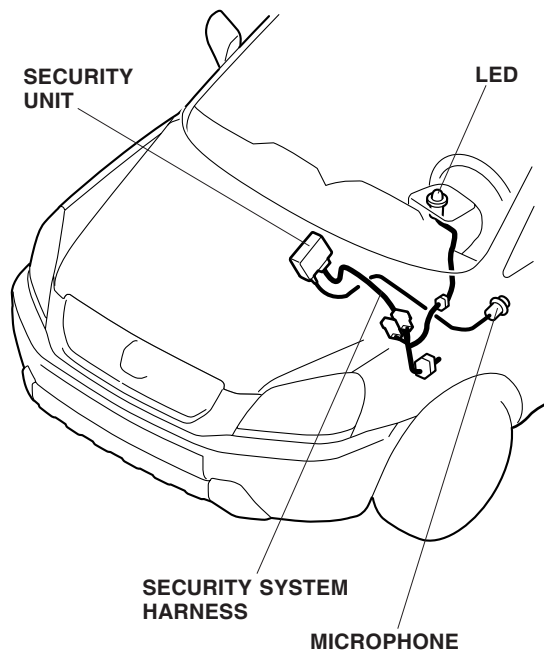

INSTALLATION

Customer Information: The information in this installation instruction is intended for use only by skilled technicians who have the proper tools, equipment, and training to correctly and safely add equipment to your vehicle. These procedures should not be attempted by “do-it-yourselfers.”

1. Make sure you have the anti-theft code for the radio, then write down the frequencies for the preset buttons.
2. Disconnect the negative cable from the battery.
3. Remove the driver's dashboard lower cover (one self-tapping screw, three clips, and two hooks).

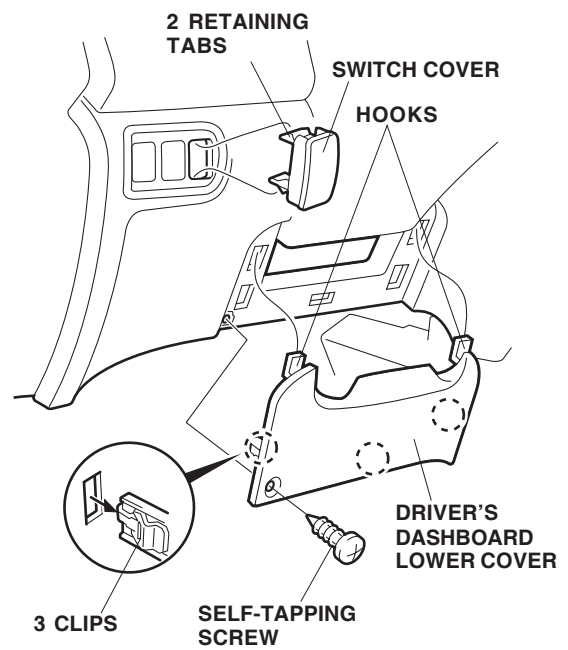

4. Remove the switch cover (two retaining tabs).

5. Lower the steering wheel using the tilt lever, then remove the upper and lower steering column covers (two washer-self-tapping screws and one screw).

- Carefully push in the seven retaining tabs to release the tabs and remove the lower steering column cover.
- Insert the ignition key in the shift lock release hole, and move the shift lever to the "N" position while pressing down on the key.
- Remove the key, then lift the upper steering column cover. Pull the cover out toward you, and remove it by lowering the shift lever to the "1" position.

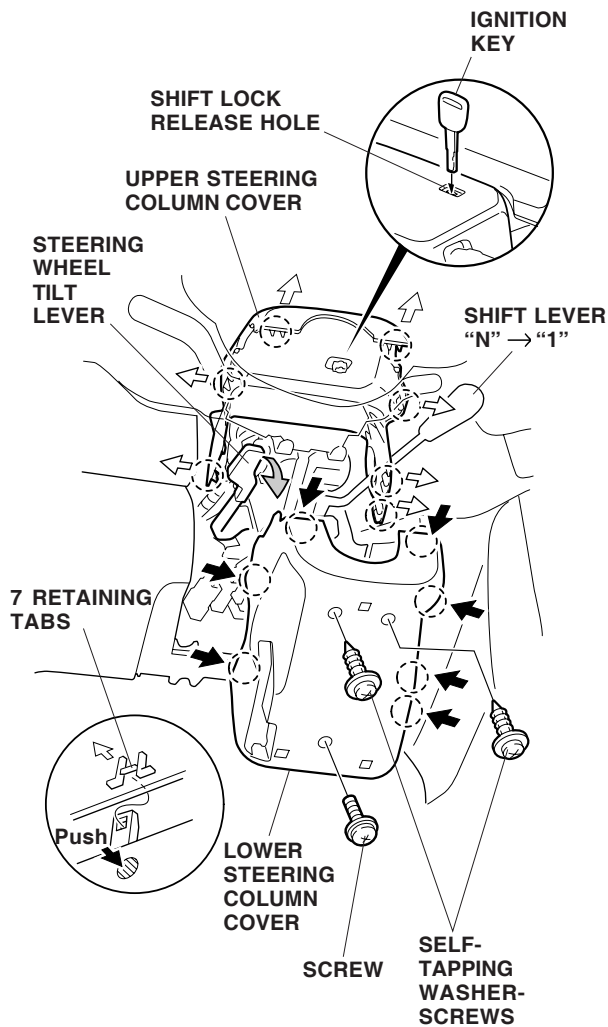

6. Remove the bolt from the steering hanger beam and remove the TPMS unit.

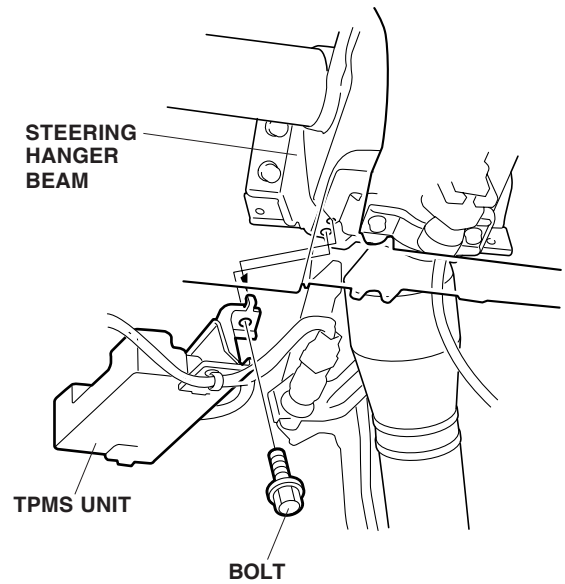

7. Slide the control unit bracket onto the security system control unit. Do not push on the connector area.

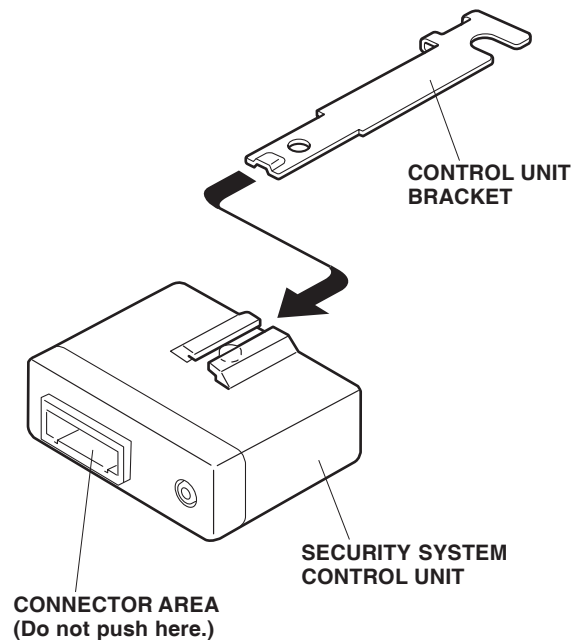

- Loosely install the flange bolt to the vehicle bracket at the right side of the steering shaft.

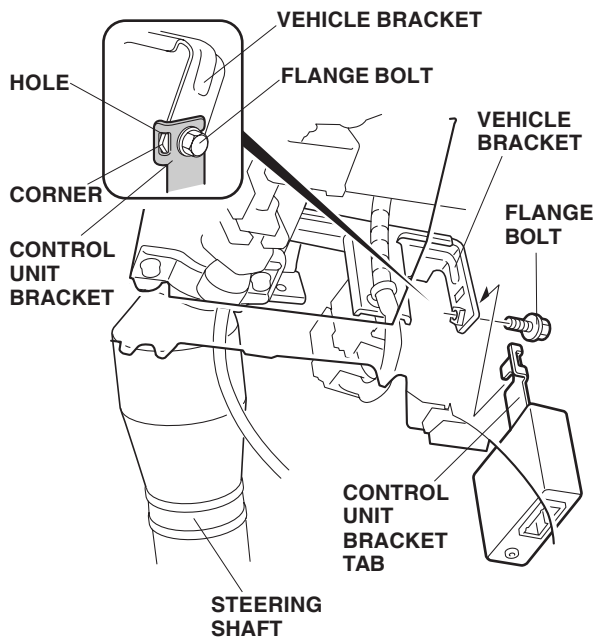

- Insert the control unit bracket onto the flange bolt. Align the tab from control unit bracket to the corner of the vehicle bracket, and tighten the flange bolt.
- Install the two wire ties with clip from the security system harness to the holes in the steering hanger beam.
- Plug the security system harness 22-pin connector into the security unit.

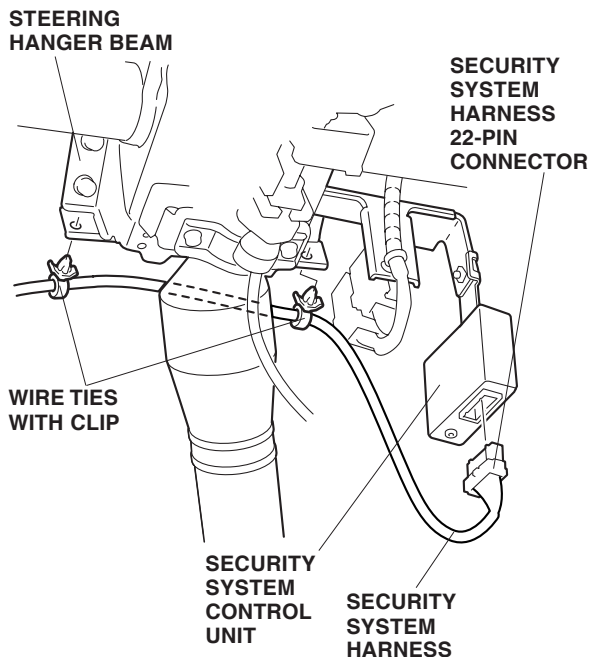

- Reinstall the TPMS unit removed in step 6.

- Below the steering hanger beam, locate the 14-pin connector blue-taped to the vehicle harness, and remove the blue tape to free the connector. Plug the security system harness 14-pin connector into the 14-pin connector you just freed.
- Secure the security system harness to the vehicle harness with the two wire ties.

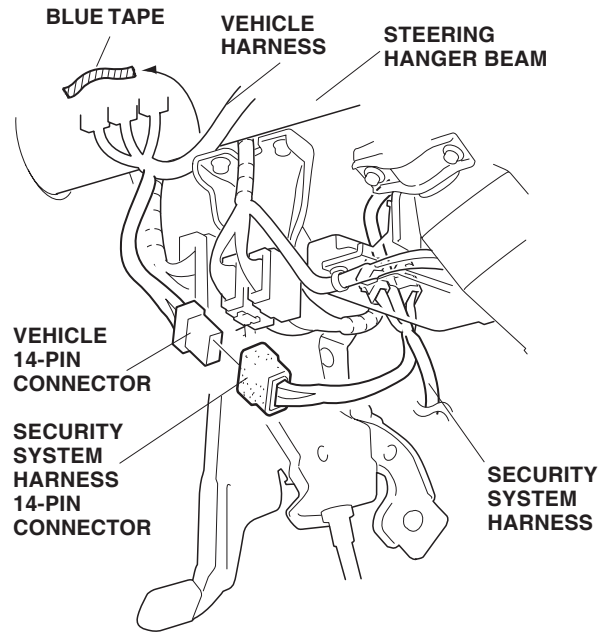

Installing the LED

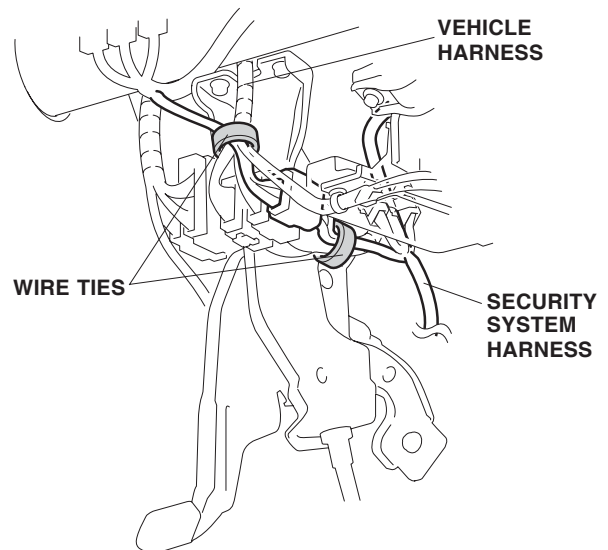

15. On the inside of the upper steering column cover, measure and mark the upper steering column cover.
16. While wearing eye protection, center-punch the mark; then drill a 5.5 mm hole through the upper steering column cover. Remove all burrs with a round file.

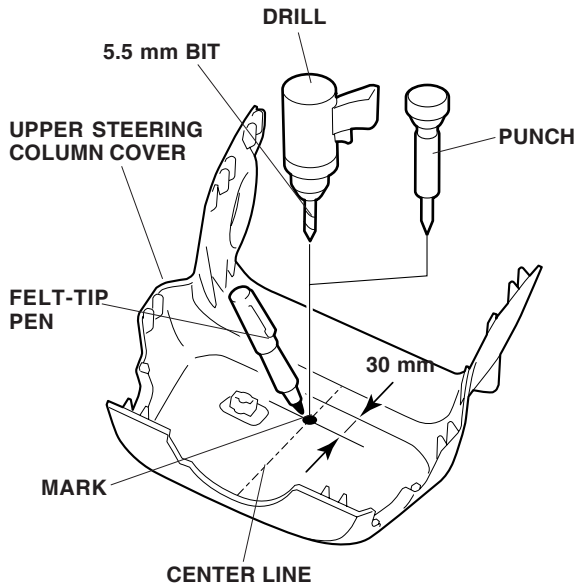

17. Route the terminal ends of the LED through the hole you just drilled, and secure the LED with the push nut. Install the push nut securely.
18. Using isopropyl alcohol, thoroughly clean the back of the upper steering column cover in the area shown. Secure the LED harness to the upper steering column cover with a cushion tape.

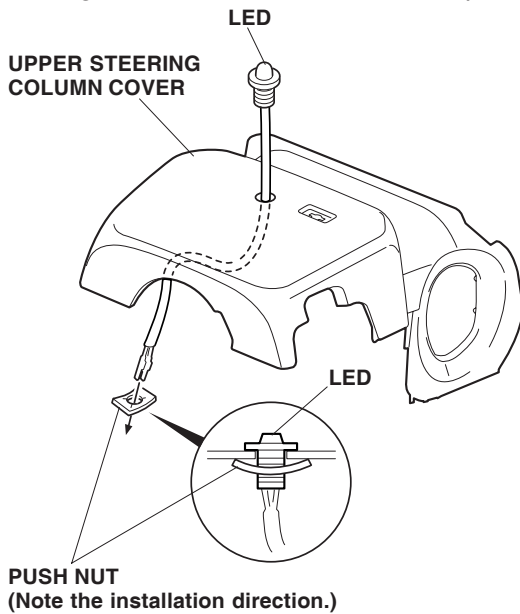

19. Get the 2-pin connector included in the kit. Firmly push the LED terminals into the 2-pin connector until they click into position, then lower the lock.

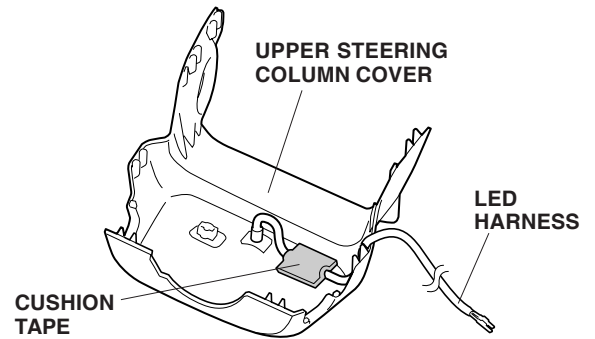

NOTE:

It is important to insert the red and white wires as shown for the LED to function.

20. Reinstall the upper steering column cover, then secure the LED harness to the vehicle harness with the wire tie.

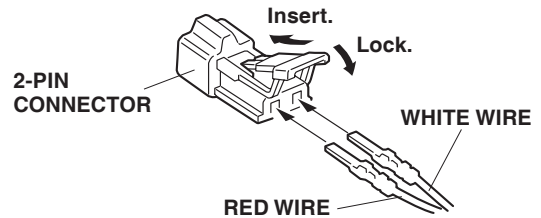

21. Route the security system harness 2-pin connector along the vehicle harness and plug it to the LED harness 2-pin connector.

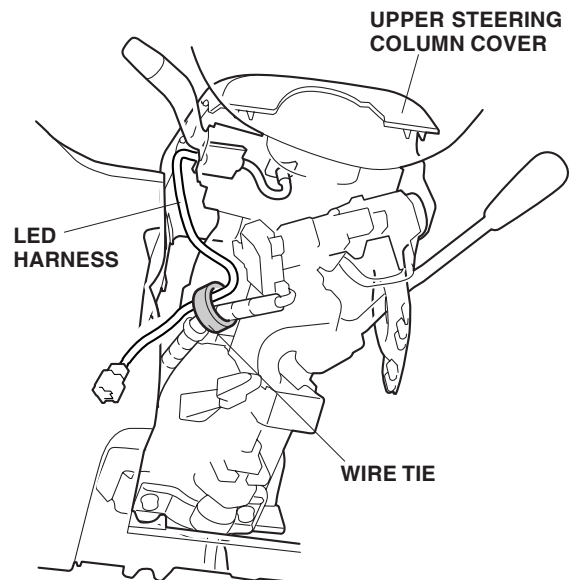

- Insert the holder bracket onto the LED harness 2-pin connector and insert the wire tie with connector holder into the holder bracket.

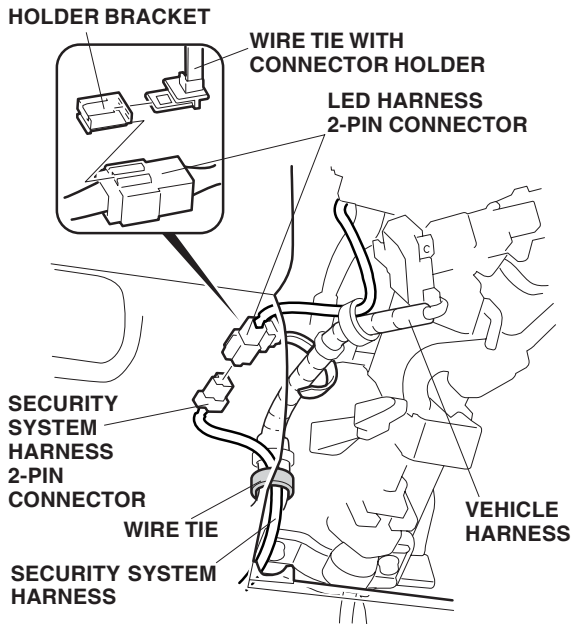

- Secure the LED harness and the security system harness to the vehicle harness with the wire tie with connector holder and the wire tie.
- Reinstall the lower steering column cover.

Installing the Microphone

- Measure and mark the center of the switch cover removed in step 4.

- While wearing eye protection, center-punch the mark; then drill an 8 mm hole through the center-punched mark. First drill a pilot hole with a 3 mm

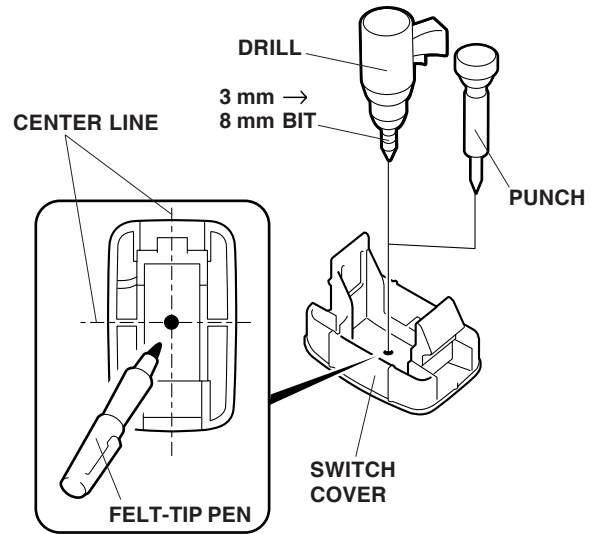

bit, then finish with an 8 mm bit. Remove all burrs.

- Route the microphone jack through the hole in the switch cover and seat the microphone in the switch cover.
- Cut two EPT sealers in half. Wrap three of the pieces around the microphone harness at the locations shown.

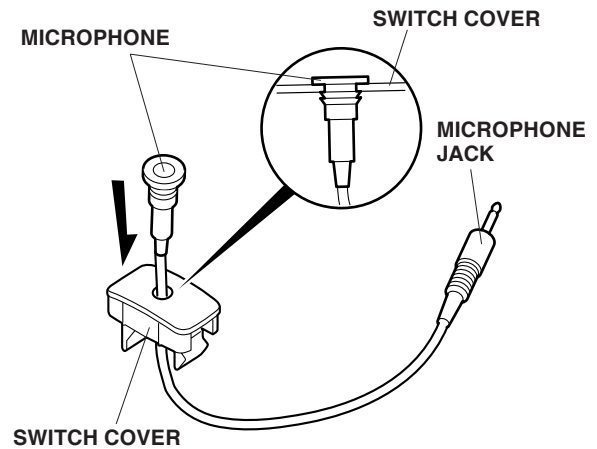

29. Secure the microphone harness to the switch cover with the small wire tie. Reinstall the switch cover.

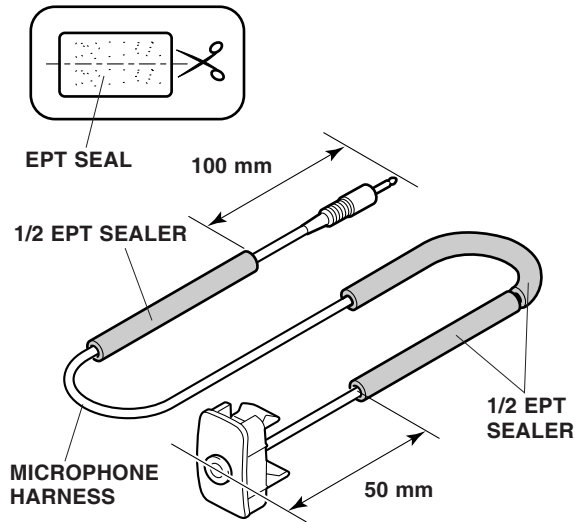

Position the tab from the wire tie in the center of the switch cover.

30. Route the microphone jack along the instrument panel, and plug it to the security system control unit.

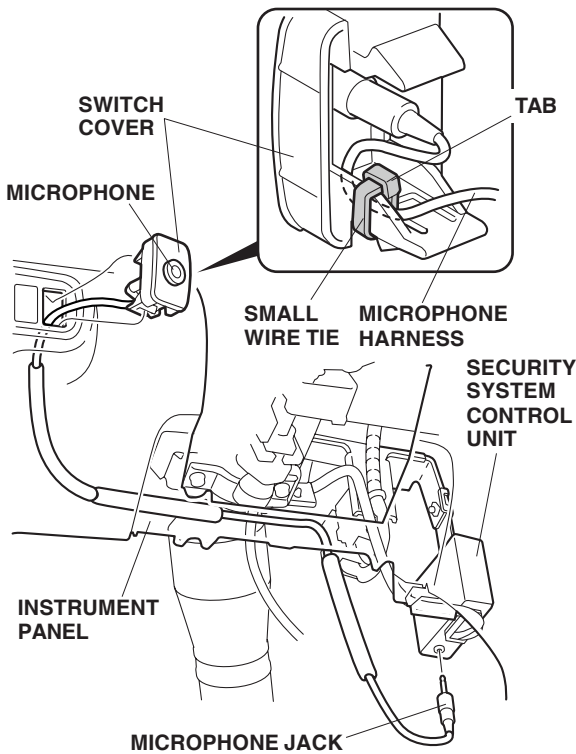

31. Secure the security system harness to the vehicle harness with one wire tie.
32. Secure the microphone harness to the security

system harness with one wire tie so that no tension is applied to the microphone jack.

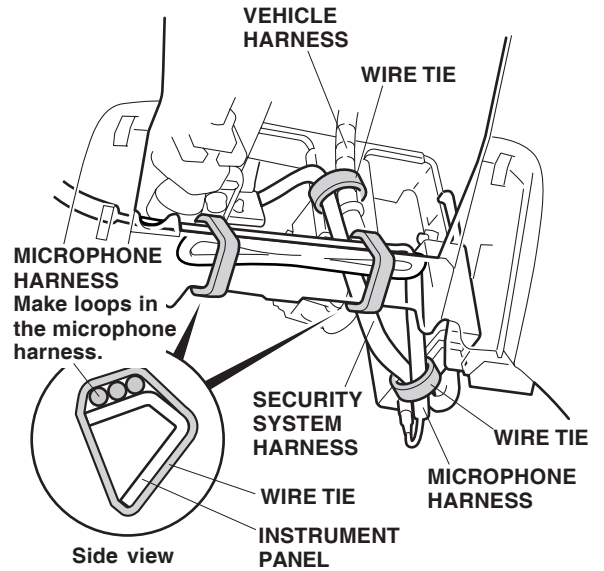

33. Loop in the excess microphone harness and secure the microphone harness to the instrument panel with two wire ties.
 34. Check that all wire harnesses and cables are routed properly and all connectors are plugged in.
 35. Reconnect the negative cable to the battery.
 36. Enter the customer's radio anti-theft code, if applicable, and reset the radio station presets.
 37. Set the clock.
 38. Check operation of the security system according to the Owner's Manual supplied.
- NOTE: Whenever the battery is disconnected, the driver's window AUTO function is disabled.
39. Start the engine. Push down on the driver's window switch until the window is fully open.
 40. Pull up on the driver's window switch to close the window completely, then hold the switch for 2 seconds.
 41. Lower and raise the driver's window to check operation of the driver's window AUTO function.