



# INSTALLATION INSTRUCTIONS

Accessory

LUGGAGE BASKET  
P/N 08L04-S9V-100

Application

2007 CR-V

Publications No.

All 33714

Issue Date

SEP 2006

Put this information in the glove box with the vehicle owner's manual.

## PARTS LIST

2 Frames A

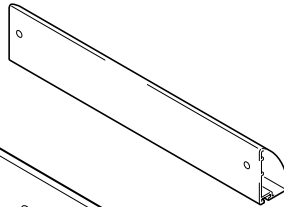

2 Frames B

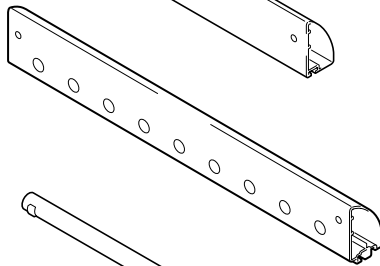

9 Pipes



Flap



4 L Brackets

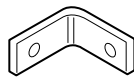

4 Bracket covers A

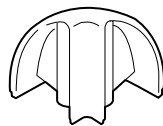

4 Bracket covers B



4 Brackets A

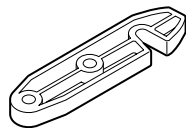

8 Bolts



8 Screws

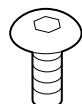

8 Self-tapping screws

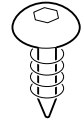

8 Nuts



8 Washers



Hex wrench

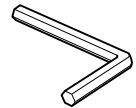

4 Brackets B

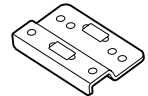

8 Square nuts



8 Socket bolts



8 Rubber pads

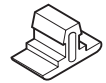

## TOOLS REQUIRED

Phillips screwdriver

10 mm Combination wrench

## INSTALLATION

### NOTE:

- Be careful not to damage the roof and finished surfaces of the body when installing the luggage basket.
- Be careful before entering automatic car washes. Check the vehicle height limit of the automatic car wash and the height of the vehicle.
- The maximum load capacity for this product is 110 lb (50 kg); approximate product weight is 12 lb (5 kg).
- Do not allow the combined weight of the accessory and cargo to exceed the carrying capacity of the roof rack.
- A Honda roof rack or cross bars are required to install the luggage basket.

1. Insert the nine pipes into frame B. Press down on the button on the end of each pipe, and push the end into the hole in frame B. Repeat on the other side.

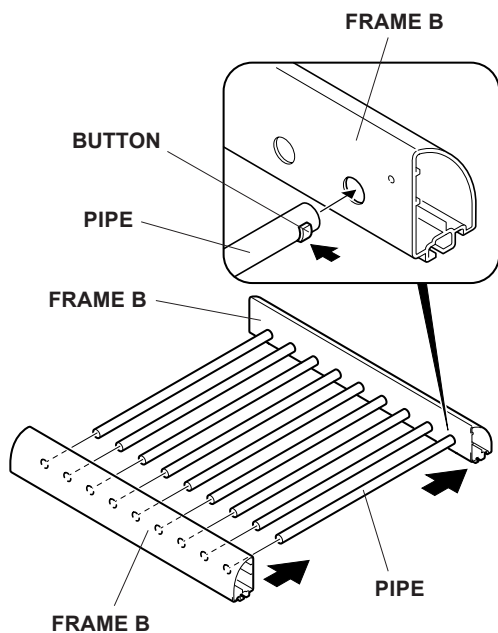

2. Slide one flap into the groove of one frame A. This will be the front of the basket.

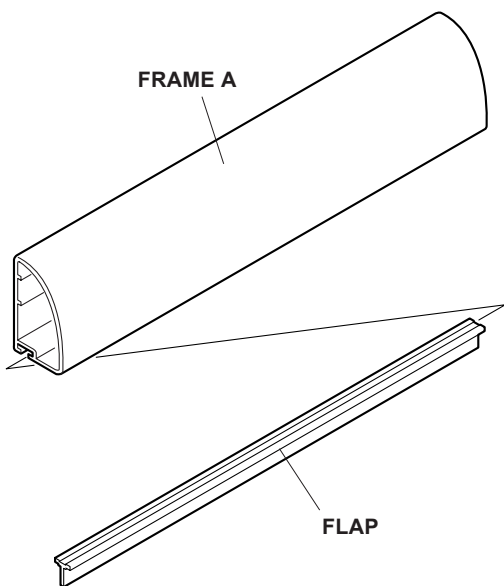

3. Attach one L bracket on each end of the frame A using one screw for each bracket.

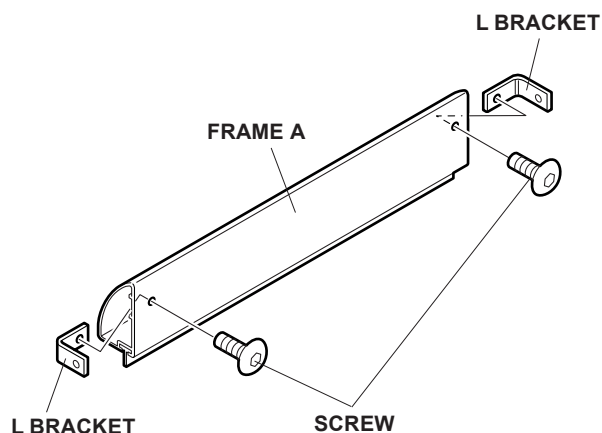

4. Install L brackets on the other frame A.
5. Attach frame A to frame B by sliding the L brackets into each frame B and installing one screw in each bracket.

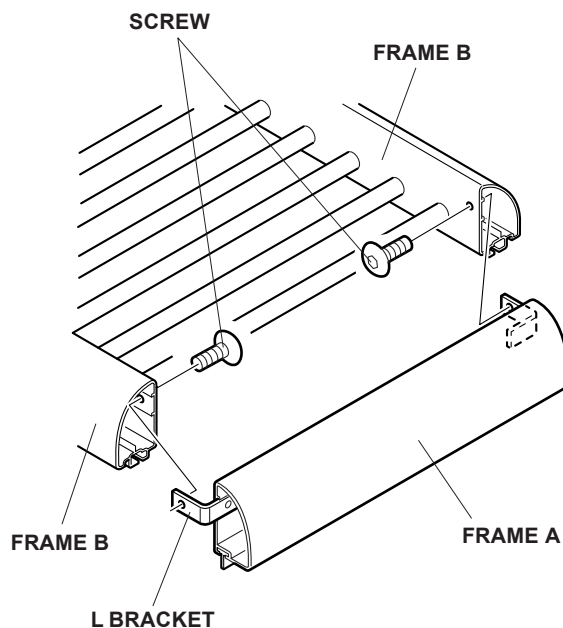

6. Attach the remaining frame A to frame B the same way.

- Slide four square nuts into each frame B through the groove shown.

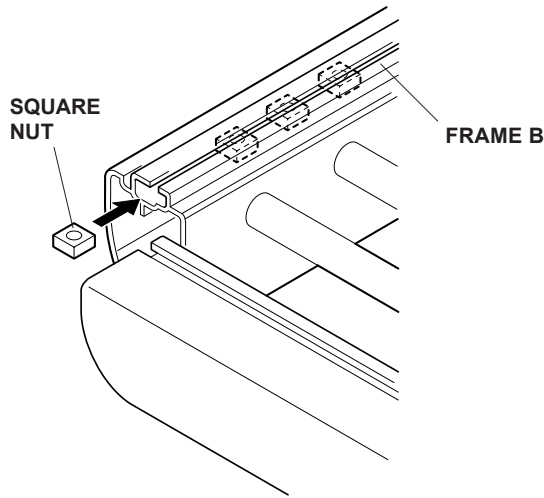

- Position four bracket covers A over the ends of the frames A and B, then install four bracket covers B and install self-tapping screws to secure the covers.

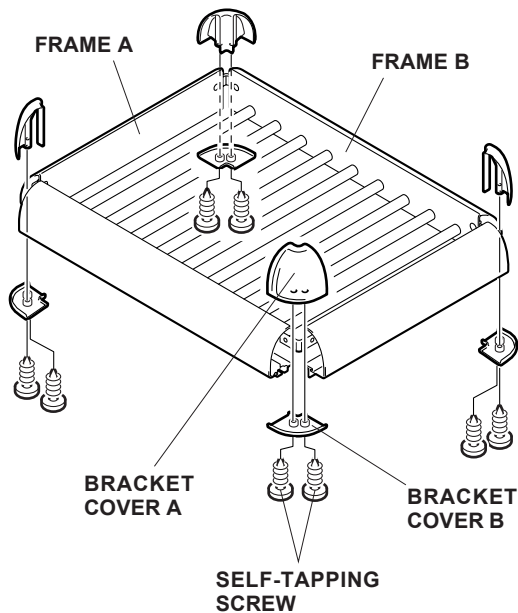

- Position four brackets B to frame B at the measurement shown, and install two socket bolts into the two square nuts for each bracket B. Install the rubber pads into brackets B as shown.

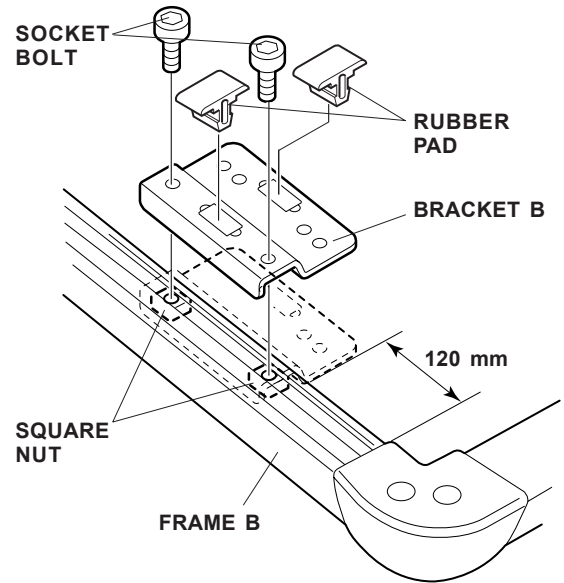

- Attach one bracket A to each of four brackets B, using two bolts, two washers and two nuts for each bracket A. Do not tighten the bolts yet.

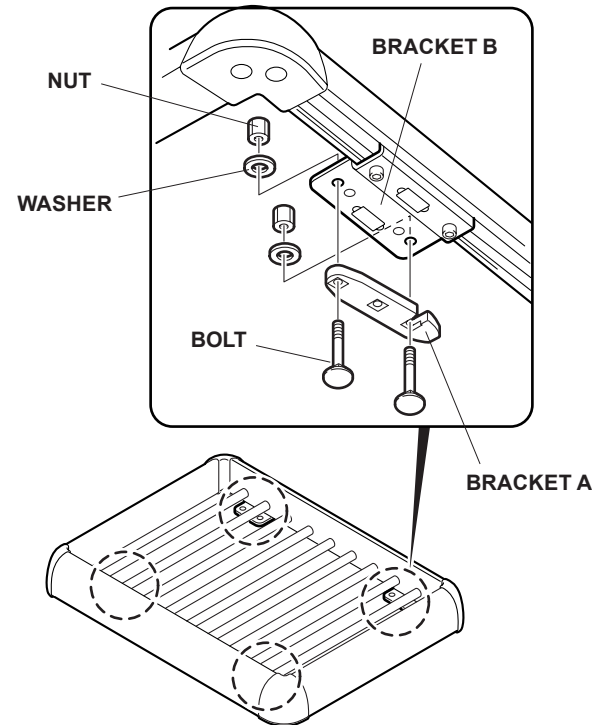

11. Position the luggage basket on the roof rack, with the flap from frame A facing forward. Attach the basket to the cross bars by sliding bracket A around the crossbar and tightening the nuts. Tighten the nuts evenly.

