



INSTALLATION INSTRUCTIONS

Accessory

FRONT UNDER SPOILER

Application

2006 S2000

Publications No.

All 31062

Issue Date

OCT 2005

PARTS LIST

Front under spoiler

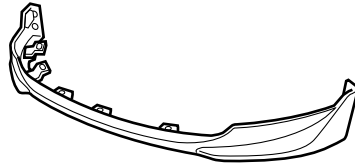

4 Fender bolts

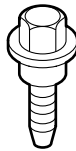

3 Stepped bolts

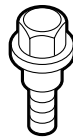

4 Self-tapping screws



5 Flange nuts



2 Clip nuts



4 Spring nuts



TOOLS AND SUPPLIES REQUIRED

Phillips screwdriver

Flat-tip screwdriver

Ratchet

10 mm Socket

Isopropyl alcohol

Clean towel

Masking tape

INSTALLATION

NOTE:

- Be careful not to damage the front bumper and body paint.
 - Install the front under spoiler only if the ambient air temperature is 60°F (15°C) or above.
 - To allow the adhesive to cure, do not wash the vehicle for 24 hours.
1. Remove the three clips from the under cover. Push up the under cover, and slide the two clip nuts onto the front bumper through the cutouts, as shown.

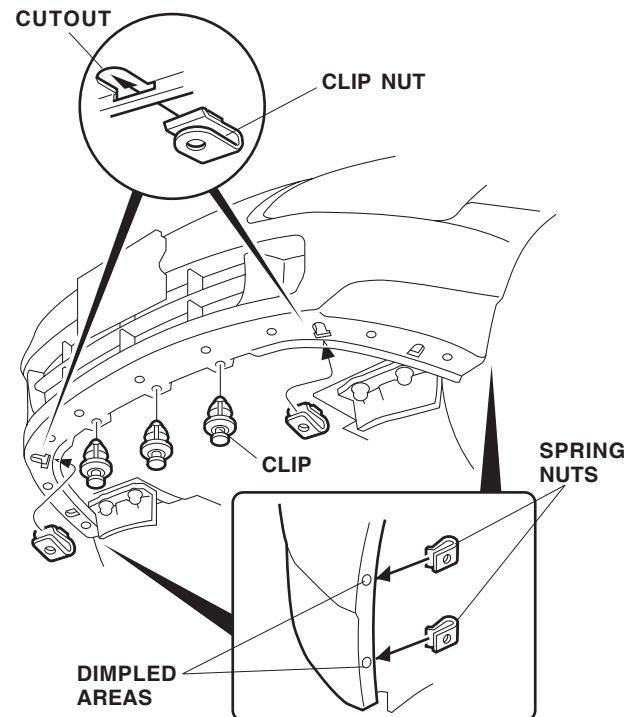

2. Slide the two spring nuts over the dimpled areas of the front bumper on each side.

- On the back of the front under spoiler, attach a piece of masking tape to the end of each of the five adhesive backings without tabs as indicated. Peel back 2 to 3 inches (50 to 75 mm) from the ends of the adhesive tapes, and attach them to the front of the under spoiler with masking tape.

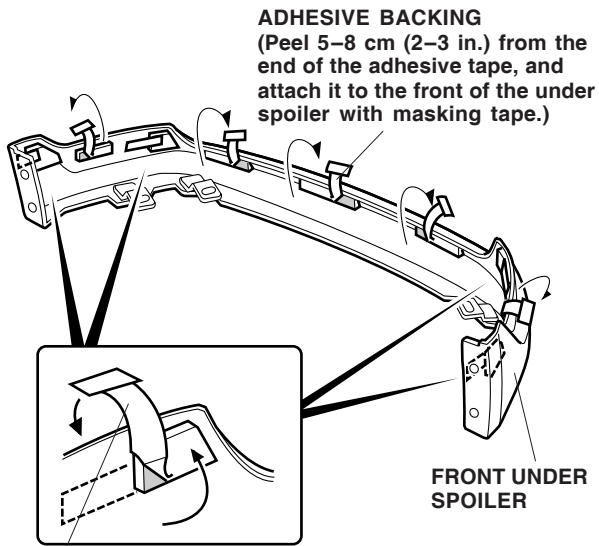

TAB
(Attach masking tape to the end, and peel the adhesive backing from the end of the adhesive tape a little by pulling the masking tape in the direction shown.)

- Pull the masking tape in the direction shown to peel the remaining adhesive backing from the four adhesive tapes a little, and attach them to the front of the under spoiler with masking tape.
- Using isopropyl alcohol on a clean towel, clean the front bumper where the adhesive tapes on the front under spoiler will attach.

- Position the front under spoiler on the front bumper, and temporarily install the four fender bolts, three stepped bolts, five flange nuts, and four self-tapping screws. Check that the molding on the front under spoiler is not tucked under the front under spoiler.

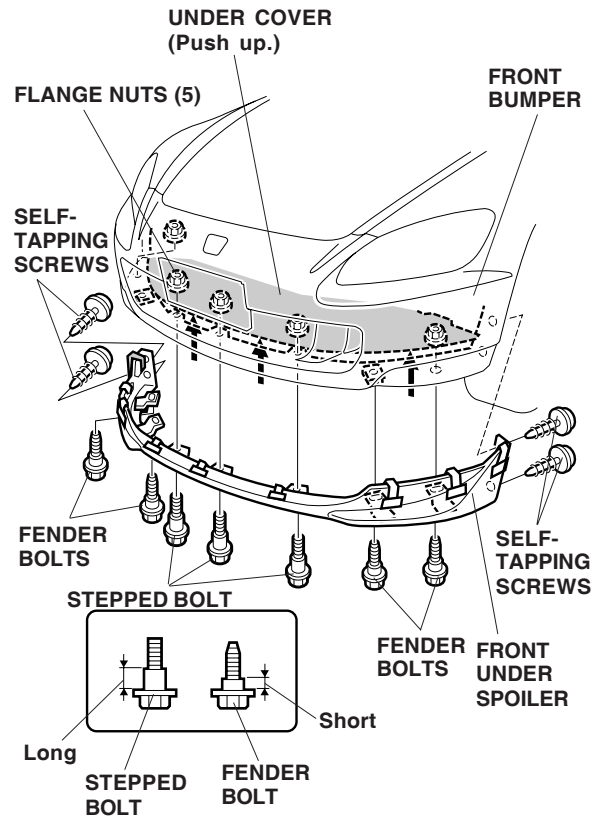

7. While holding pressure up on the front under spoiler, carefully remove the nine adhesive backings in the order shown:
 - When removing the adhesive backings, pull the front under spoiler out toward you to allow clearance between the front under spoiler and the front bumper.
 - After removing the adhesive backings, hold the front under spoiler firmly against the front bumper with the palm of your hand for 30 seconds, particularly at the edges.

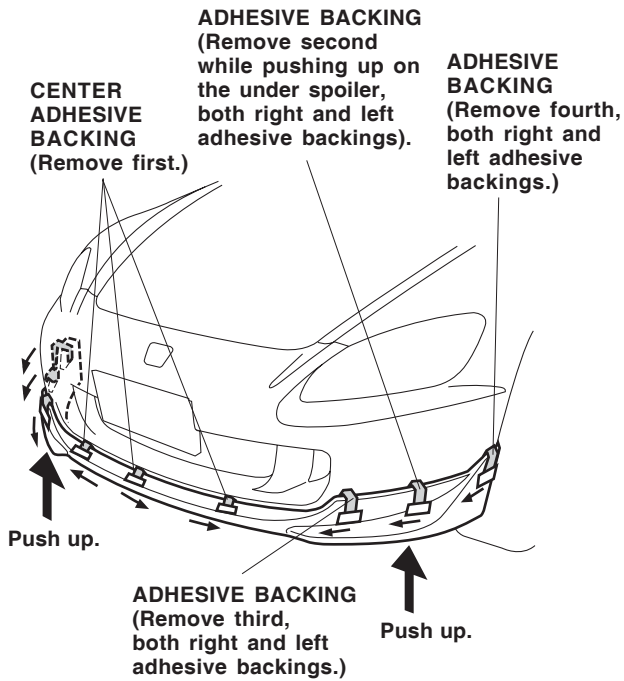

8. Tighten the fender bolts, stepped bolts, flange nuts, and self-tapping screws temporarily installed in step 6.
9. Reinstall the clips removed in step 1.