



INSTALLATION INSTRUCTIONS

Accessory

CARGO LINER
P/N 08P42-S9V-100

Application

2006 PILOT

Publications No.

All 30662

Issue Date

SEP 2005

Put this information in the glove box with the vehicle owner's manual.

PARTS LIST

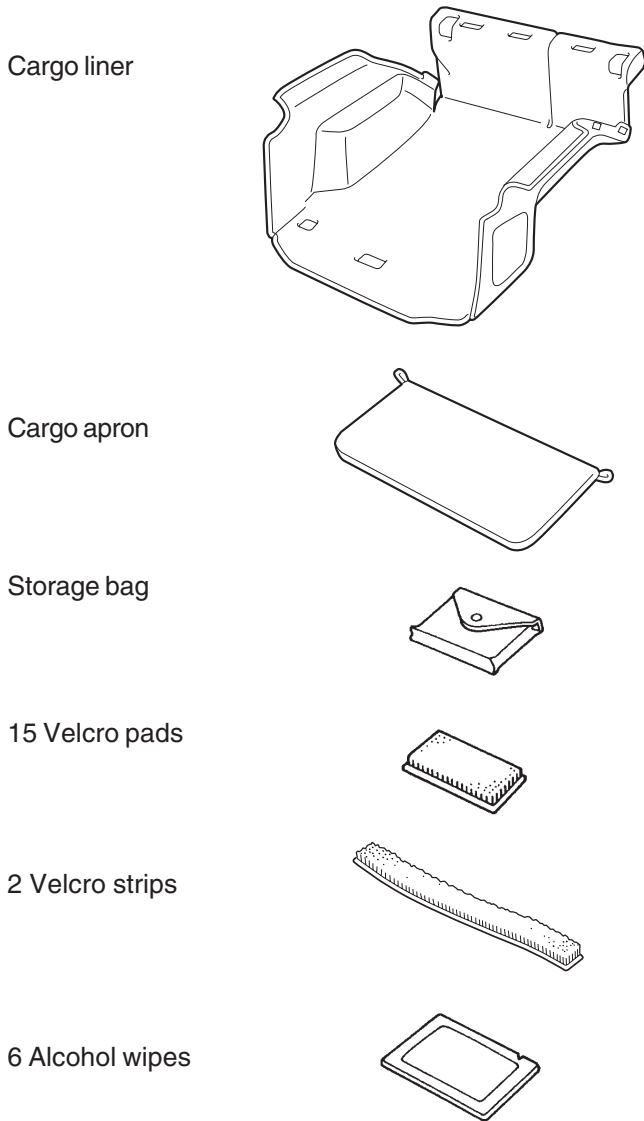

TOOL REQUIRED

Small flat-tip screwdriver

INSTALLATION

NOTE: Before closing the tailgate, remove the cargo apron from the cargo liner, or place it in the storage position.

Installing the Cargo Liner

1. Attach the two Velcro strips and the 15 Velcro pads to the cargo liner in the areas shown.

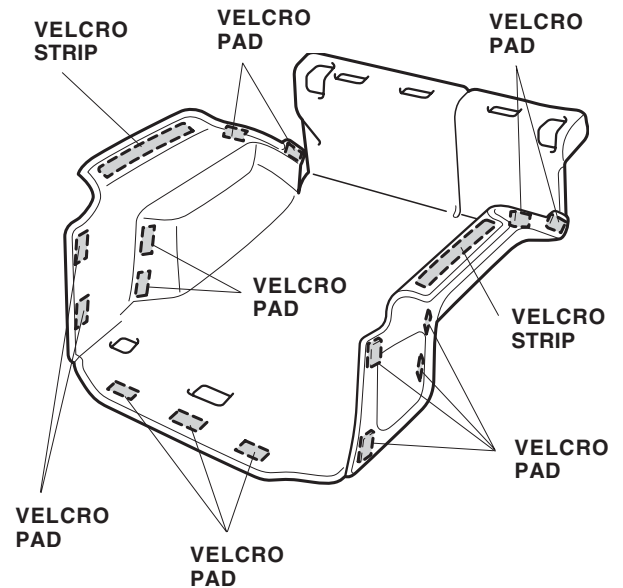

2. Using a small flat-tip screwdriver, or the ignition key, release the seat belt lower hook from each third row seat. Attach the seat belt clips to the seat belts.

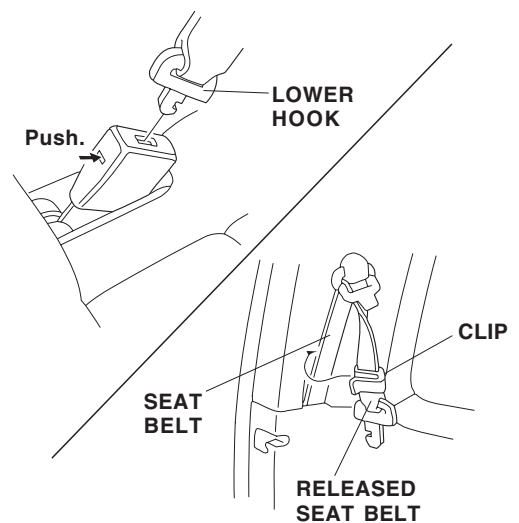

- Remove the headrests from the third row seats; push the release buttons and pull the headrests out.

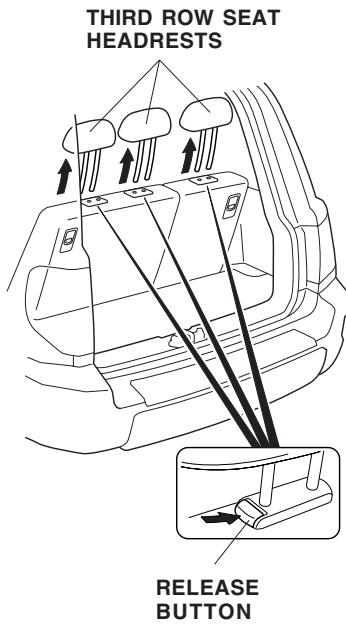

- Store the headrests in the storage compartment under the cargo floor. Insert the posts of the headrests into the holes in the front of the storage compartment.

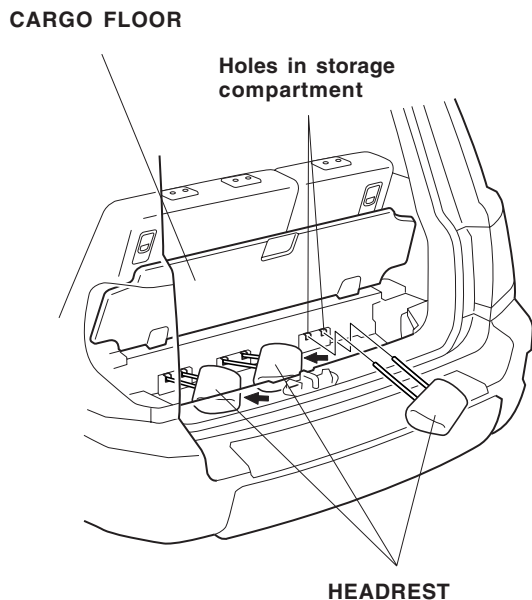

- Fold down both of the third row seats.

- Remove the headrests from the second row seats; push the release buttons and lift the headrests out.

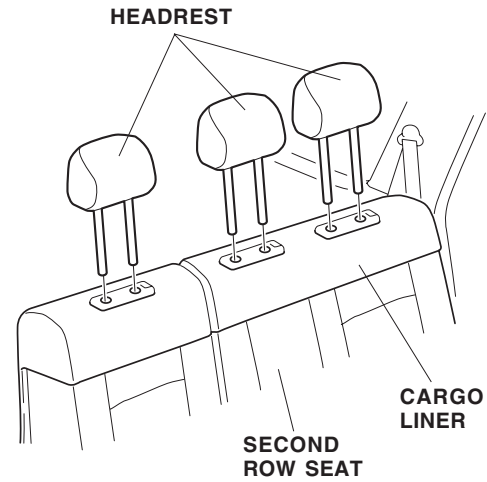

- Install the cargo liner over the second row seat, then reinstall the headrests.

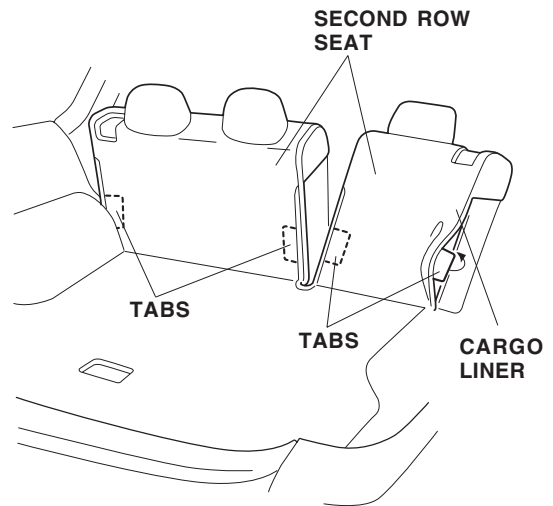

- With the second row seat partially folded down, install the four tabs into the sides of the second row seats.
- Fold down both of the second row seats.

10. Insert the two tabs (one on each side) attached to the cargo liner into the seam between the third row seats and the floor.

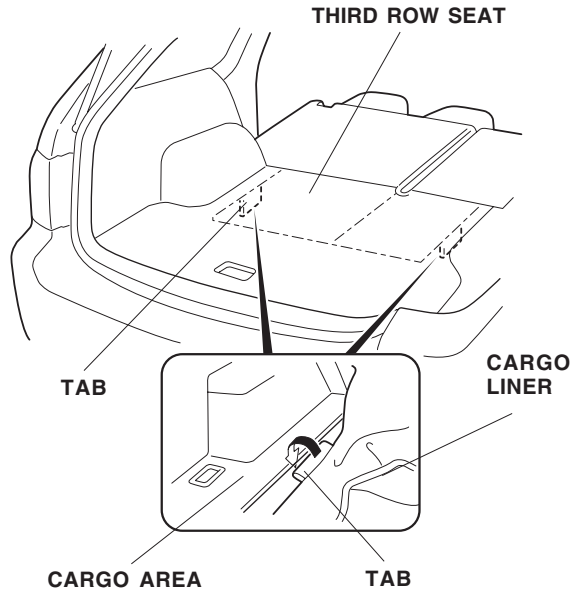

11. Open the cargo area floor lid, and fit the pocket of the cargo liner around the floor lid. Using one alcohol wipe, clean the area where the Velcro pads will attach.

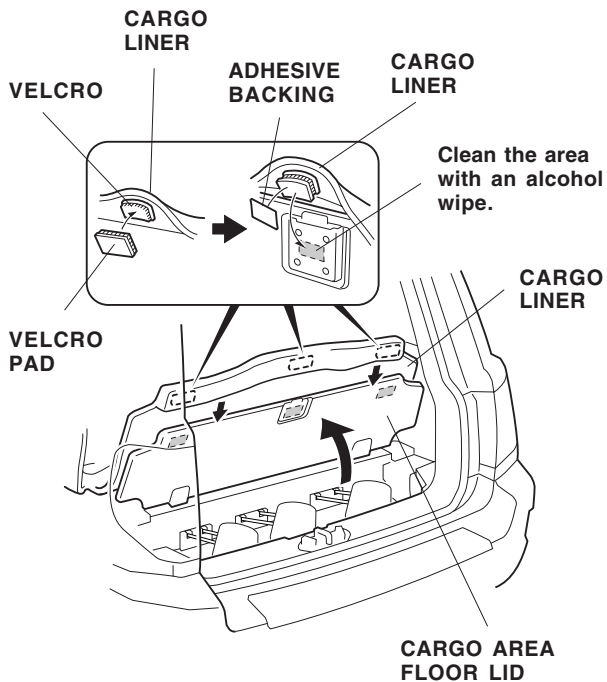

12. Remove the adhesive backing from each Velcro pad, and attach the Velcro pads to the storage compartment cover. Press the Velcro pads firmly against the cover with the palm of your hand.

13. Along the front edge of the right rear fenderwell, locate the Velcro pads attached to the cargo liner. Pull the liner snug, and locate the area on the right rear side trim panel where the Velcro pads will be attached. Using one alcohol wipe, clean the area where the Velcro pads will attach.

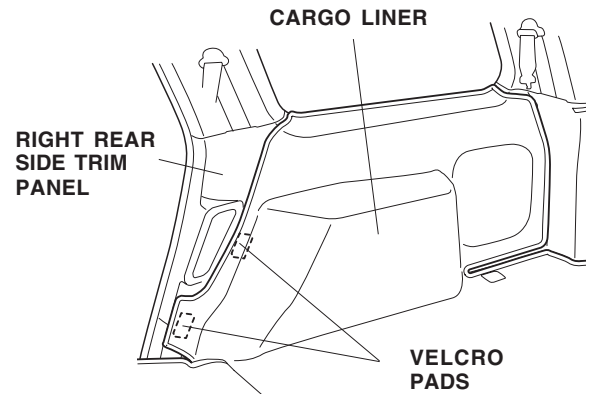

14. Remove the adhesive backing from each Velcro pad. Press the Velcro pads firmly against the right rear side trim panel with the palm of your hand.
15. Along the top of the right rear side trim panel near the quarter glass, fit the liner into place. Locate the Velcro strip attached to the cargo liner, and note its location along the trim panel. Using one alcohol wipe, clean the area where the Velcro strip will attach.

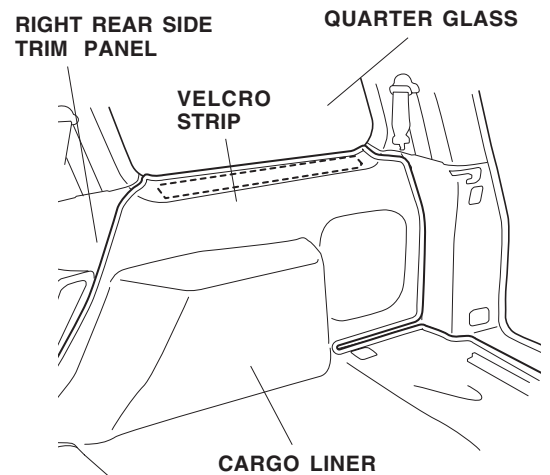

16. Remove the adhesive backing from the Velcro strip, fold the cargo liner over, and attach the strip to the right rear side trim panel. Press the Velcro strip firmly against the trim panel with the palm of your hand.

- At the right rear corner, locate the two Velcro pads attached to the cargo liner, and note their location on the right rear side trim panel. Using one alcohol wipe, clean the area where the Velcro pads will attach.

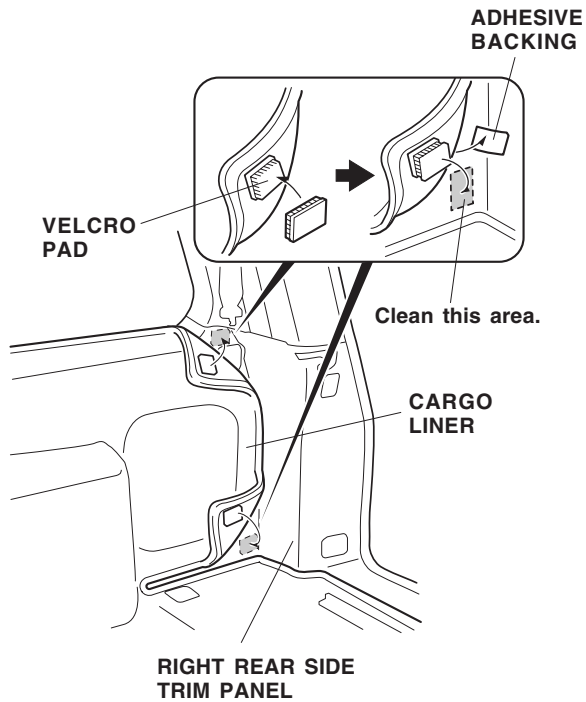

- Remove the adhesive backing from each Velcro pad, fold the cargo liner over, and attach the Velcro pads to the right rear side trim panel. Press the Velcro pads firmly against the trim panel with the palm of your hand.
- Repeat steps 13 through 18 to install the cargo liner to the left rear side trim panel.

Installing the Cargo Apron

- Attach the Velcro strip on the cargo apron to the Velcro strip on the cargo liner.

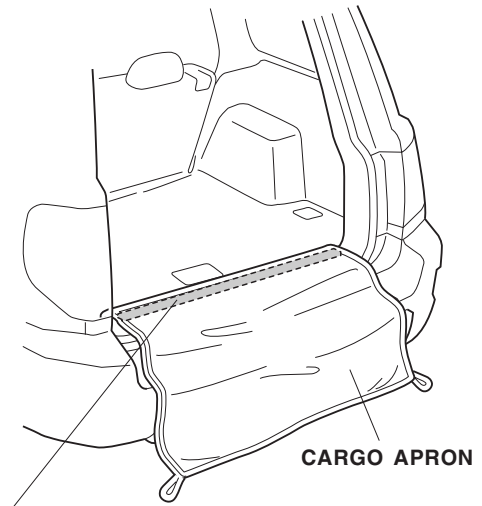

VELCRO STRIP
Align the Velcro strip on the cargo apron with the Velcro strip on the cargo liner.

- Attach the loops of the cargo apron to the vehicle hooks in the cargo area.

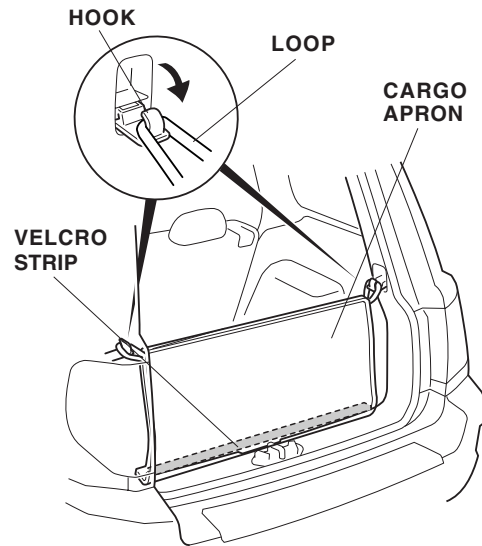

CLEANING THE CARGO LINER

To clean the cargo liner, wipe with a solution of mild detergent and water on a soft cloth or sponge, then wipe dry with a clean cloth or sponge.