



INSTALLATION INSTRUCTIONS

Accessory
BICYCLE ATTACHMENT ROOF MOUNT

Application
2006 ODYSSEY

Publications No.
All 30401
Issue Date
AUG 2005

Put this information in the glove box with the vehicle owner's manual.

PARTS LIST

Bike Attachment
P/N 08L07-TA1-101

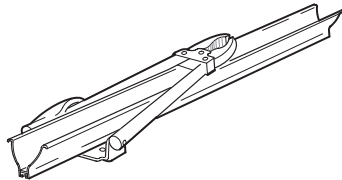

2 Wheel straps



2 End caps



Allen wrench, 5 mm

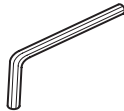

2 Keys



Instruction sheet



Hardware Kit
P/N 08L07-S0X-100

3 T-bolts



TOOLS REQUIRED

T-25 Torx driver
#3 Phillips screwdriver
Torque wrench

1. Remove the three mounting levers and T-bolts from the bike attachment, and set them aside to be installed later.

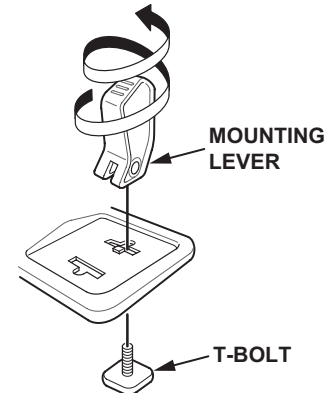

Installing the Bike Attachment

2. Remove the rubber moldings from the front and rear roof rack crossbars. Retain the rubber moldings to reinstall if the bike attachment is removed.

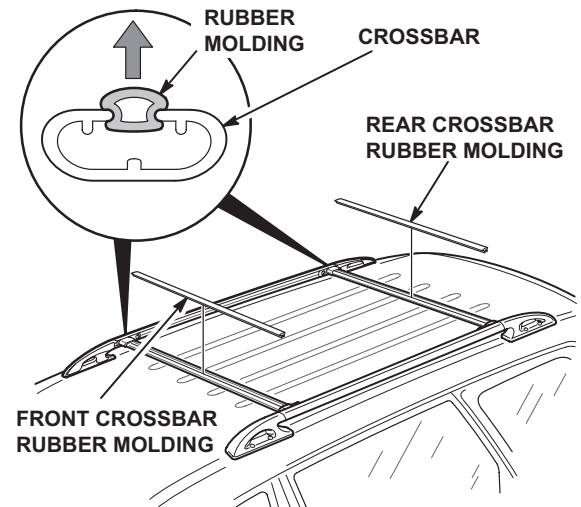

- Remove the roof rack assembly from the roof (eight Phillips screws). Leave the adapter blocks in their original positions.

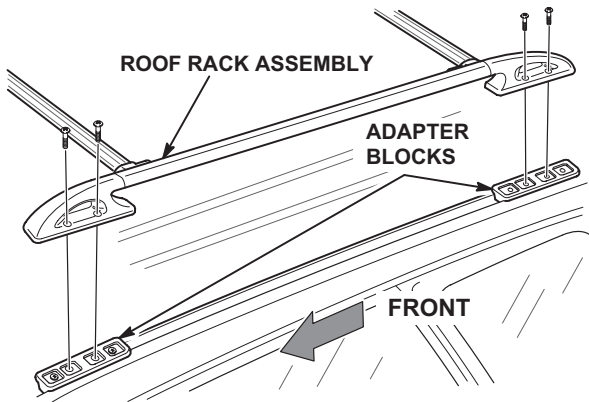

- Using a T-25 Torx driver, remove the Torx screw from each roof rack crossbar (front and rear) on one side of the roof rack, then remove the side rail from the roof rack.

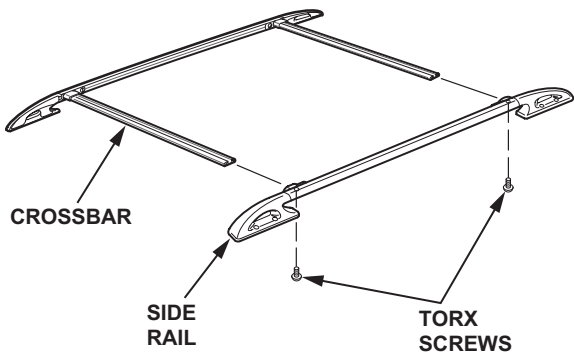

- Install the appropriate number of T-bolts into the channel of the crossbar (two T-bolts for the front of the bike attachment, and one T-bolt for the rear). On the EX model, use the T-bolts included in the hardware kit.

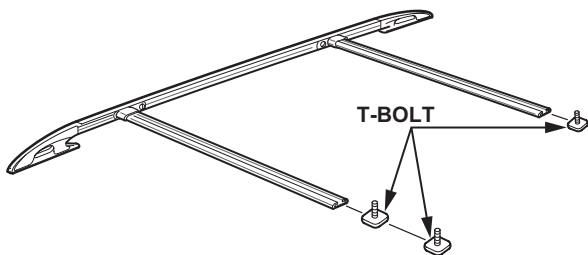

- Reinstall the side rail on the roof rack with the Torx screws removed in step 4. Tighten the screws securely.
- Reinstall the roof rack, and tighten the eight screws securely. Torque the Phillips screws to 7 to 11 N·m (5 to 8 ft-lb).
- Position the bike attachment over the T-bolts you installed on the roof rack, and install the mounting levers removed in step 1. Do not tighten or lock the mounting levers at this time.

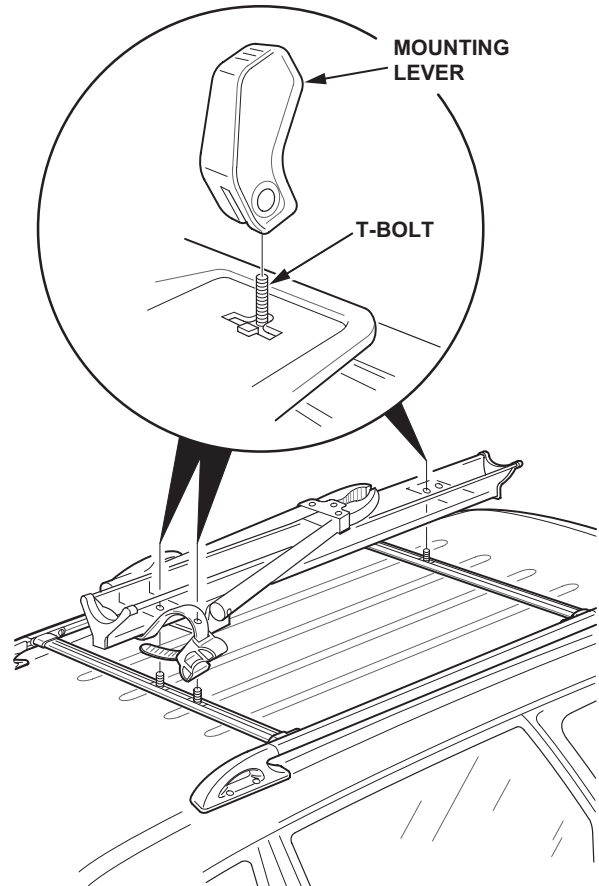

- Position the bike attachment on the front and rear crossbars. Turn and adjust the mounting lever to lock the bike attachment to the roof rack. Check for firm pressure while you push down on the mounting lever to lock it into place.

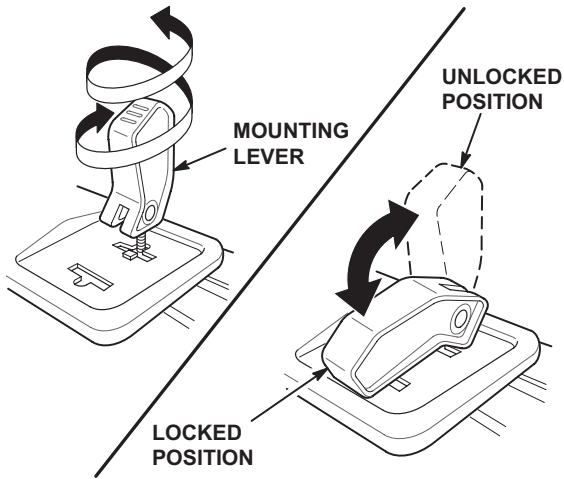

- If the mounting lever pressure is too tight (the lever will not lock into place), lift up on the lever and turn it counterclockwise.
- If the mounting lever pressure is too loose (the lever locks into place, but the bike attachment is loose on the crossbars), lift up on the lever and turn it clockwise.

- If needed, use the 5 mm Allen wrench (supplied) to check and tighten the clamping jaw mounting hardware.

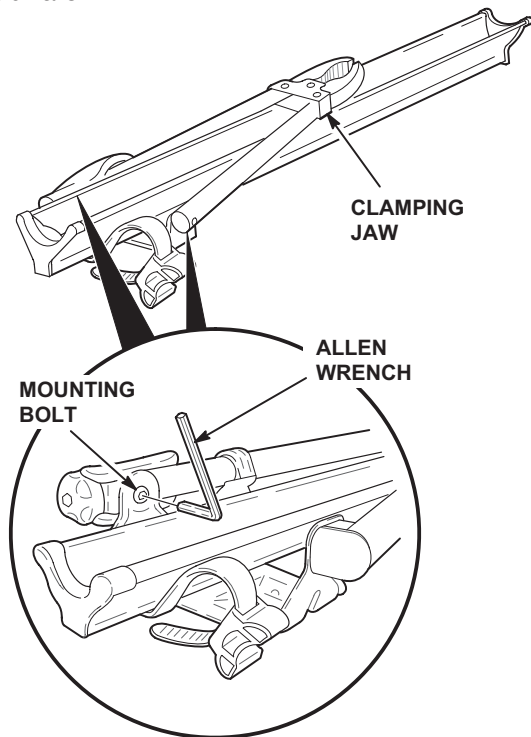

- Slide the security retainer in place, then close the locking clamp lever. To deter theft of the bike attachment, lock the locking clamp lever with the key.

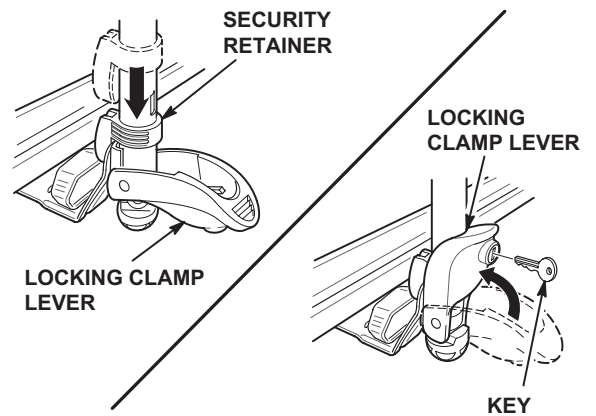

- Put these instructions and the Bicycle Installation Instructions in the glove box for future reference.
- Put the Allen wrench and the keys in the glove box for future use.
- Put the rubber moldings removed in step 2 in a plastic bag, and put the bag in the vehicle for the customer.