



INSTALLATION INSTRUCTIONS

Accessory

**HALF NOSE MASK
P/N 08P35-SVA-100A**

Application

2006 CIVIC SI

Publications No.

All 31392

Issue Date

NOV 2005

Put this information in the glove box with the vehicle owner's manual.

PARTS LIST

Mask
(hood section)

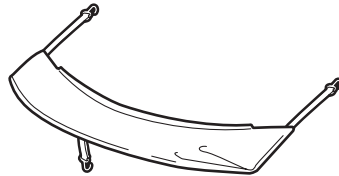

Right side mask
(fender section)

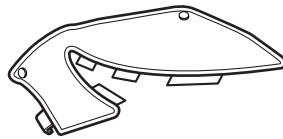

Left side mask
(fender section)

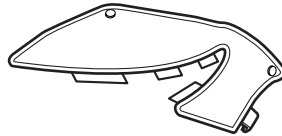

2 Snap-screws (A)



2 Washers



2 Fenderwell nuts



2 Clips



2 Snap-screws (B)



Storage bag

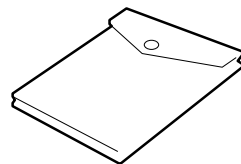

TOOLS AND SUPPLIES REQUIRED

Stubby Phillips screwdriver

Flat-tip screwdriver

INSTALLATION

NOTE:

- Make sure the vehicle and the nose mask are clean and completely dry before installation. If moisture under the mask is allowed to dry, it may cloud the paint. If the mask gets wet, remove it and allow it to air-dry completely.
- Make sure any repainted surfaces are cured.
- Make sure the hood and nose of the vehicle have been waxed with a high-quality paste wax.
- Make sure to install the nose mask securely. If the nose mask starts to flap or comes loose while driving, safely pull off the highway, stop the vehicle, and secure or remove the mask.

Installing the Hood Section

1. Open the hood. Fit the corners of the mask around the hood. Adjust the mask so that it fits smoothly over the edges. Attach the "S" hooks to the hood.

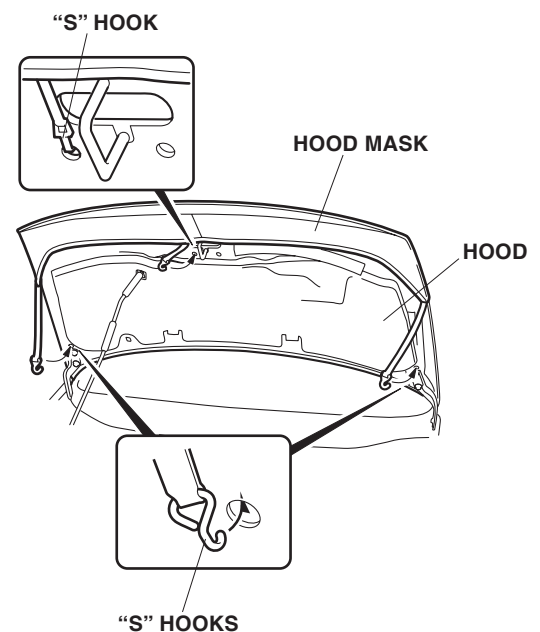

Installing the Fender Section

2. Remove the clip from the left front fender.

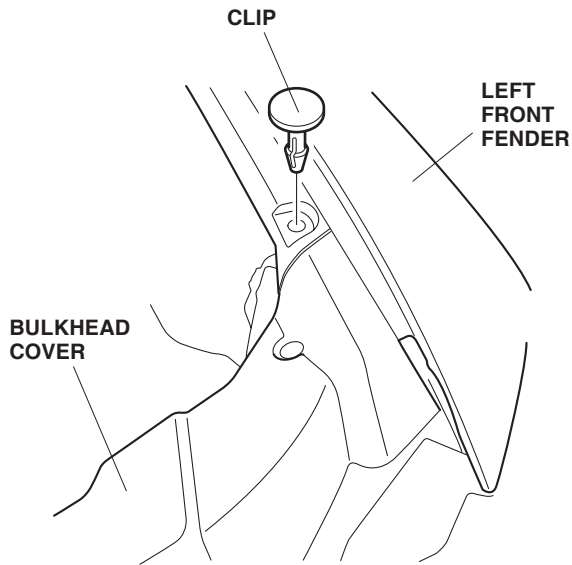

3. Install one new clip with a snap-screw(B) into the hole where you removed the clip, and tighten the snap-screw(B).

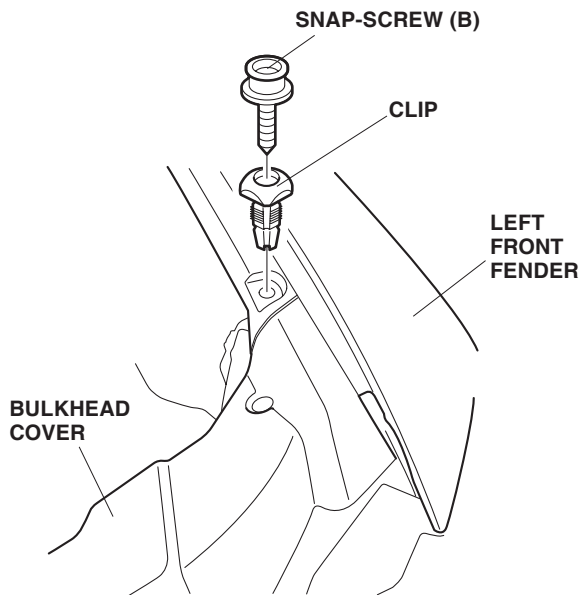

4. Repeat steps 2 and 3 to install a snap-screw (B) on the right side of the vehicle.

5. Turn the steering wheel all the way clockwise.

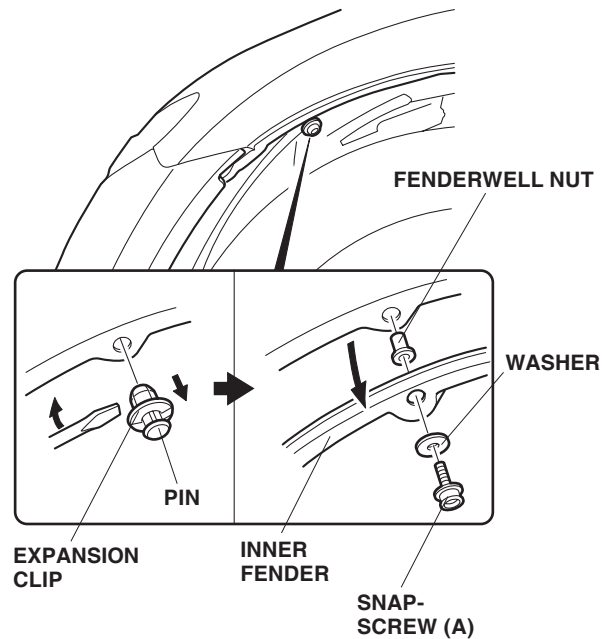

6. Pry out the plastic pin, and remove the expansion clip that fastens the inner fender. Remove and retain the clip, then clean the area around the hole.
7. Pull the inner fender away, and press one fenderwell nut (supplied) into the hole in the fender flange.
8. With its washer in place, securely tighten one snap-screw (A) into the fenderwell nut.
9. Turn the steering wheel all the way counterclockwise, and repeat steps 6 through 8 on the right side.

- Slip the pocket of the mask's fender section onto the front corner of the fender.

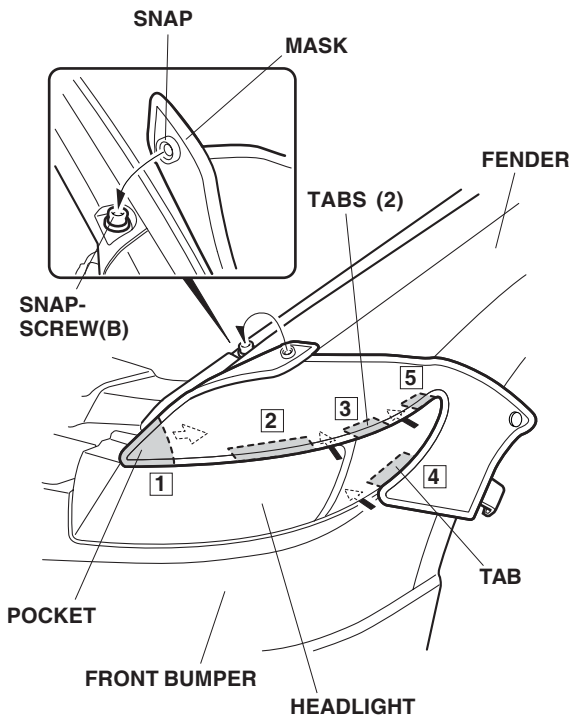

- Attach the snap on the mask to the snap-screw (B) you installed in step 3.
- Insert four tabs between the headlight and the front bumper in the order shown.

- Pull the mask back toward the wheelwell, smooth out any wrinkles, then snap the mask onto the snap-screw (A).

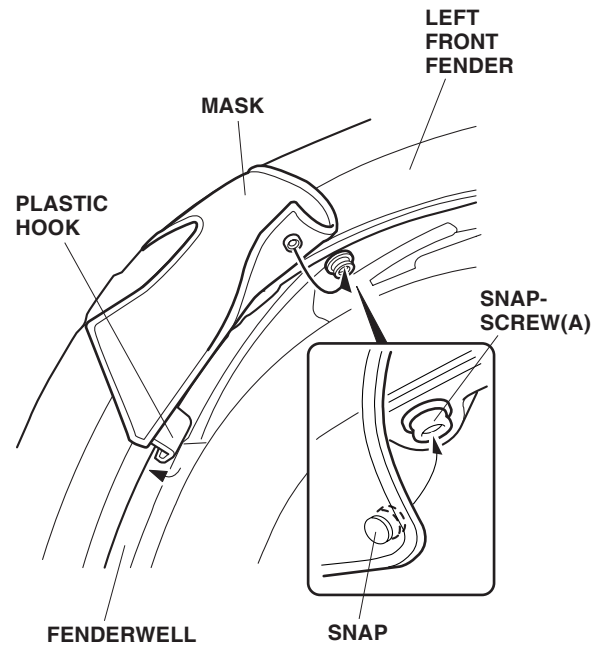

- Attach the plastic hook to the fenderwell.
- Repeat steps 10 thru 14 to attach the fender section of the mask to the right side of the vehicle.
- Put these instructions, the two clips (removed in step 2), and the two expansion clips (removed in step 6) in the glove box.

CLEANING THE NOSE MASK

Use a sponge or cloth and a solution of mild liquid dishwashing soap and water to clean the vinyl and the flannel backing. Rinse the mask completely with clean water, and hang it to dry out of direct sunlight. Make sure the mask is completely dry before you reinstall it.