



INSTALLATION INSTRUCTIONS

Accessory

**FULL NOSE MASK
P/N 08P35-SNA-100**

Application

**2006 CIVIC
HYBRID**

Publications No.

All 30327

Issue Date

SEP 2005

Put this information in the glove box with the vehicle owner's manual.

PARTS LIST

Mask
(hood section)

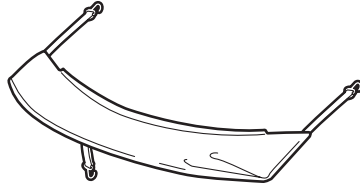

Mask
(bumper section)

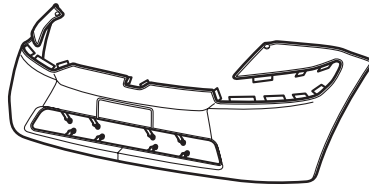

2 Snap-screws (A)



2 Washers



2 Fenderwell nuts



2 Clips



2 Snap-screws (B)



Elastic cord

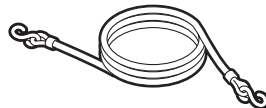

Storage bag

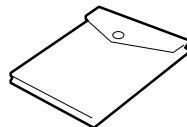

TOOLS AND SUPPLIES REQUIRED

Stubby Phillips screwdriver

Flat-tip screwdriver

Scissors

INSTALLATION

NOTE:

- Make sure the vehicle and the nose mask are clean and completely dry before installation. If moisture under the mask is allowed to dry, it may cloud the paint. If the mask gets wet, remove it and allow it to air-dry completely.
- Make sure any repainted surfaces are cured.
- Make sure the hood and nose of the vehicle have been waxed with a high-quality paste wax.
- Make sure to install the nose mask securely. If the nose mask starts to flap or comes loose while driving, safely pull off the highway, stop the vehicle, and secure or remove the mask.

Displaying the Front License Plate

If your state law requires the display of both license plates, cut out the piece of the bumper section that covers the front license plate:

- Face the inside of the mask toward you.
- Carefully cut out the license plate section with scissors at the top seam, and remove the overcast stitching.

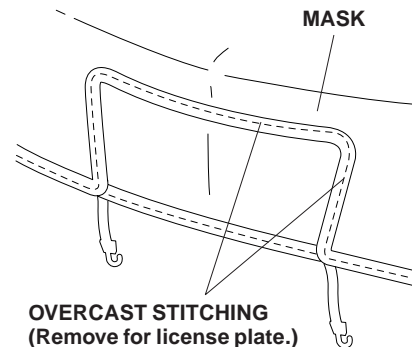

Installing the Hood Section

1. Open the hood. Fit the corners of the mask around the hood. Adjust the mask so that it fits smoothly over the edges. Attach the "S" hooks to the hood.

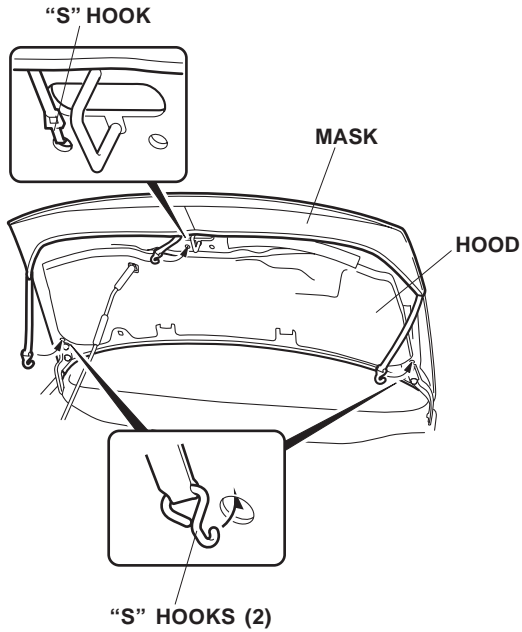

Installing the Fender Section

2. Remove the clip from the left front fender.

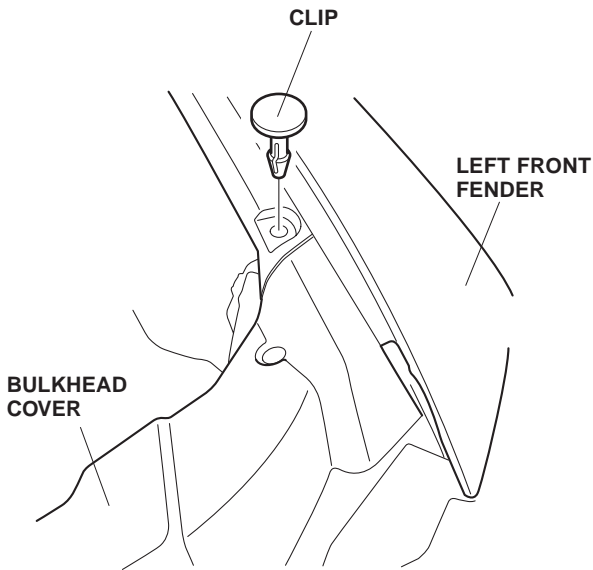

3. Install one new clip with a snap-screw (B) into the hole where you removed the clip, and tighten the snap-screw (B).

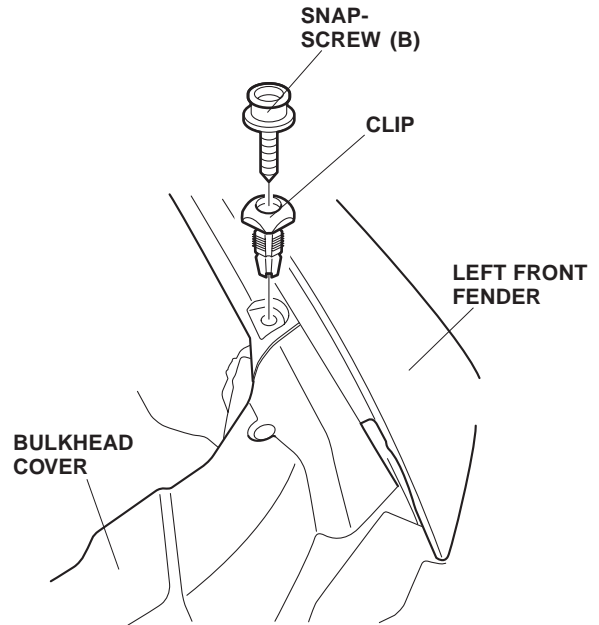

4. Repeat steps 2 and 3 to install a snap-screw (B) on the right side of the vehicle.

5. Turn the steering wheel all the way clockwise.
6. Pry out the plastic pin, and remove the expansion clip that fastens the inner fender. Clean the area around the hole.

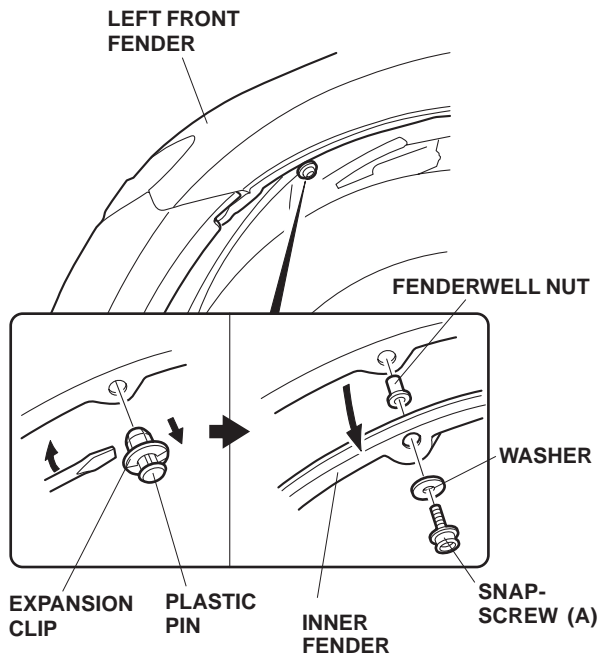

7. Pull the inner fender down, and press one fenderwell nut (supplied) into the hole in the fender flange.
8. With its washer in place, securely tighten one snap-screw (A) into the fenderwell nut.
9. Turn the steering wheel all the way counterclockwise, and repeat steps 6 through 8 on the right side.

10. Slip the pocket of the mask bumper section onto the front corner of the fender.

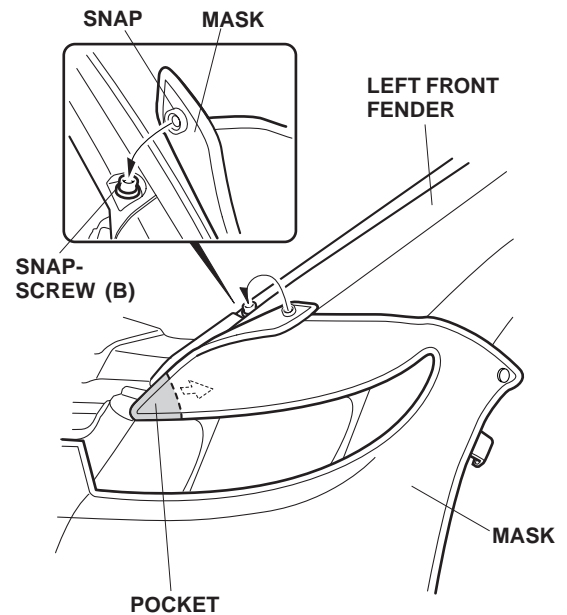

11. Attach the snap on the mask to the snap-screw (B) you installed in step 3.
12. Repeat steps 10 and 11 on the right side.
13. Insert the tabs between the headlight, the front bumper, the fender, and front grille.

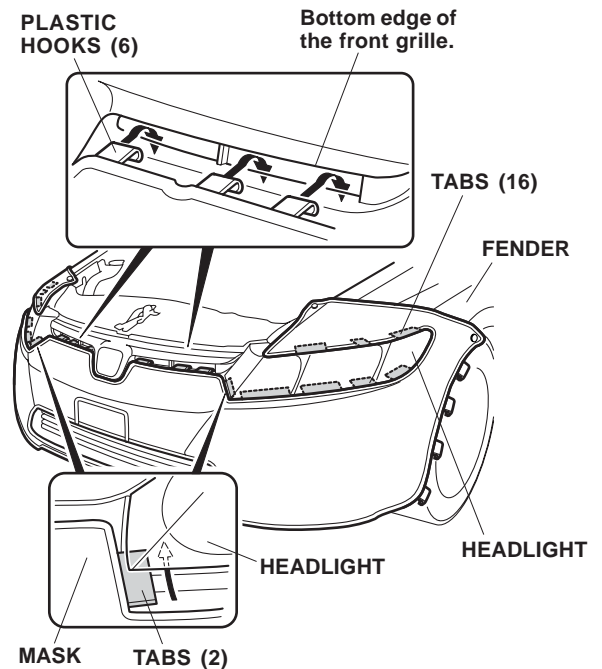

14. Attach the six plastic hooks to the bottom edges of the front grille.

15. Pull the mask back toward the wheelwell, smooth out any wrinkles, and then snap the mask onto the snap-screw (A). Repeat on the other side.

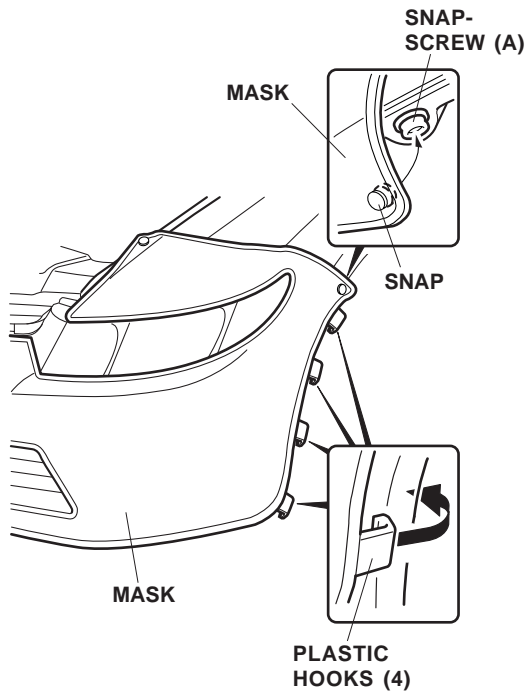

16. On both sides of the vehicle, attach the four plastic hooks to the fenderwell.
17. Attach the four "S" hooks to the inside top edge of the bumper grille opening.

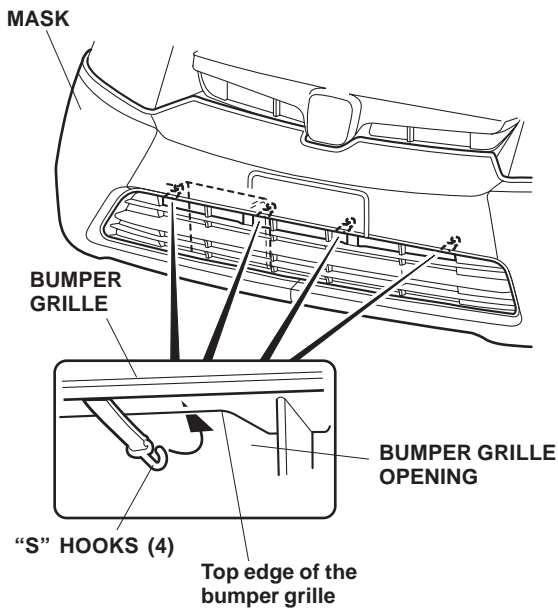

18. Attach the four "S" hooks to the bottom inside edge of the bumper grille opening.

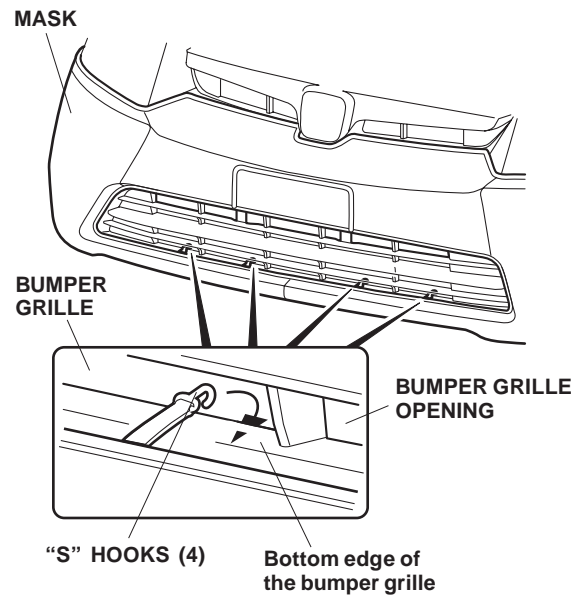

19. Route the elastic cord through the ten loops on the bottom of the mask. Attach one "S" hook to the bottom edge of the bumper on one side. Stretch out the cord after routing it through each loop, then attach the other "S" hook to the bottom edge of the bumper on the other side.

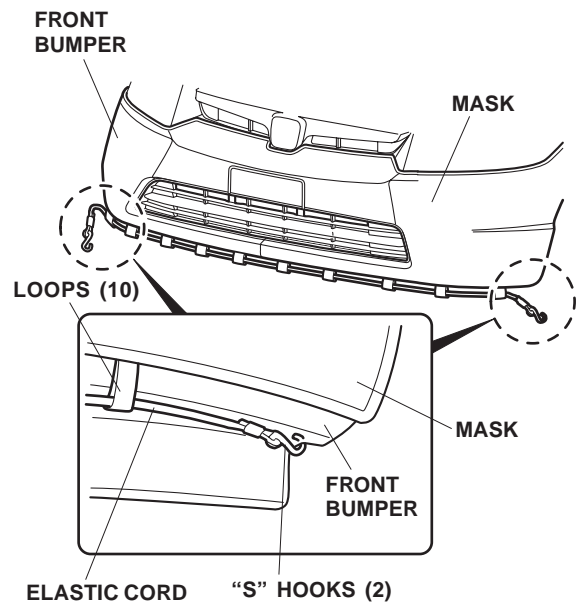

20. Put these instructions, the two clips (removed in step 2), and the two expansion clips (removed in step 6) in the glove box.

CLEANING THE NOSE MASK

Use a sponge or cloth and a solution of mild liquid dishwashing soap and water to clean the vinyl and the flannel backing. Rinse the mask completely with clean water, and hang it to dry out of direct sunlight. Make sure the mask is completely dry before you reinstall it.