



# INSTALLATION INSTRUCTIONS

Accessory	Application	Publications No.
		Issue Date
<b>SPLASH GUARDS P/N 08P00-S0X-100</b>	<b>2004 ODYSSEY</b>	<b>All 26029</b>
		<b>AUG 2003</b>

## PARTS LIST

Right front splash guard

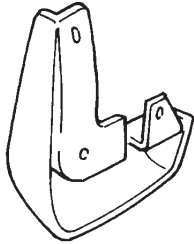

Left front splash guard

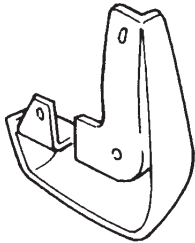

Right rear splash guard

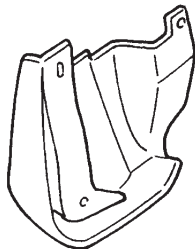

Left rear splash guard

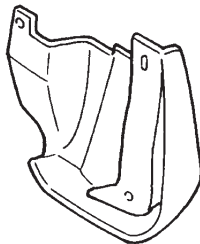

6 Self-tapping screws



4 Spring nuts



2 Grommets



## TOOLS REQUIRED

Stubby Phillips screwdriver  
Phillips screwdriver

## INSTALLATION

NOTE: These installation instructions show the left splash guards being installed; the same procedure applies to installing the right splash guards.

### Installing the Front Splash Guards

1. Clean and wax the areas to be covered with a high-quality paste wax.
2. Turn the steering wheel all the way counterclockwise to provide access to the left front fenderwell.
3. Remove the three self-tapping screws securing the inner fender to the fenderwell.

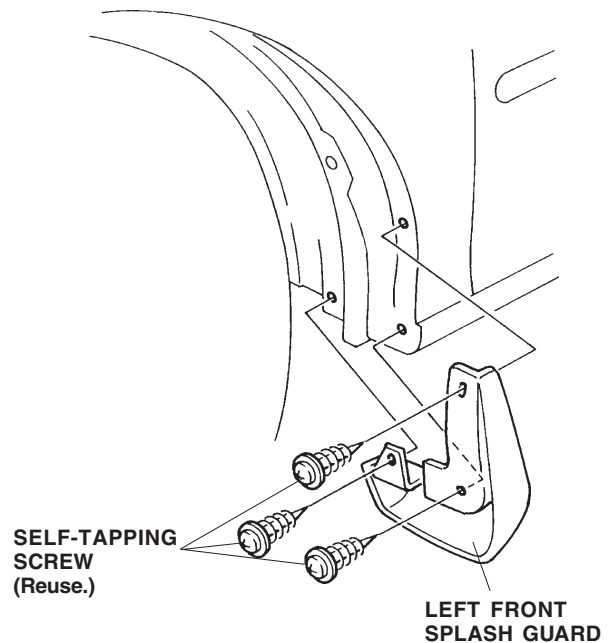

4. Position the left splash guard on the fenderwell, and reinstall the three self-tapping screws. Tighten the screws securely.
5. Turn the steering wheel all the way clockwise, and repeat steps 3 and 4 to install the right front splash guard.

## Installing the Rear Splash Guards

- Slide two spring nuts over the dimpled areas of the rear bumper. Press a plastic grommet into the hole in the fenderwell.

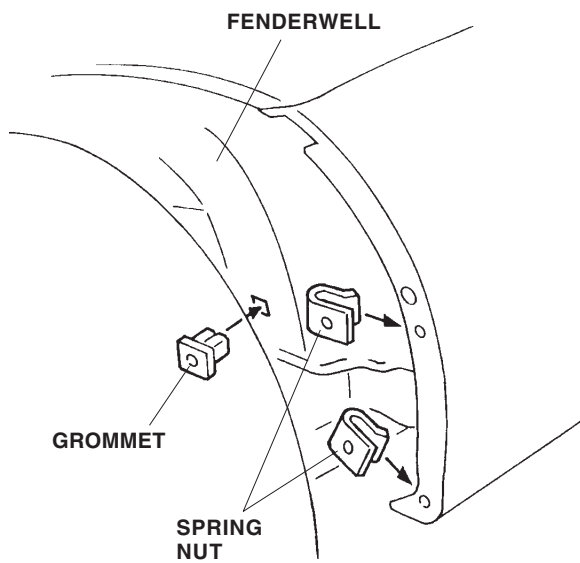

- Position the left rear splash guard on the fender and bumper, and install three of the self-tapping screws provided. Tighten the screws securely.

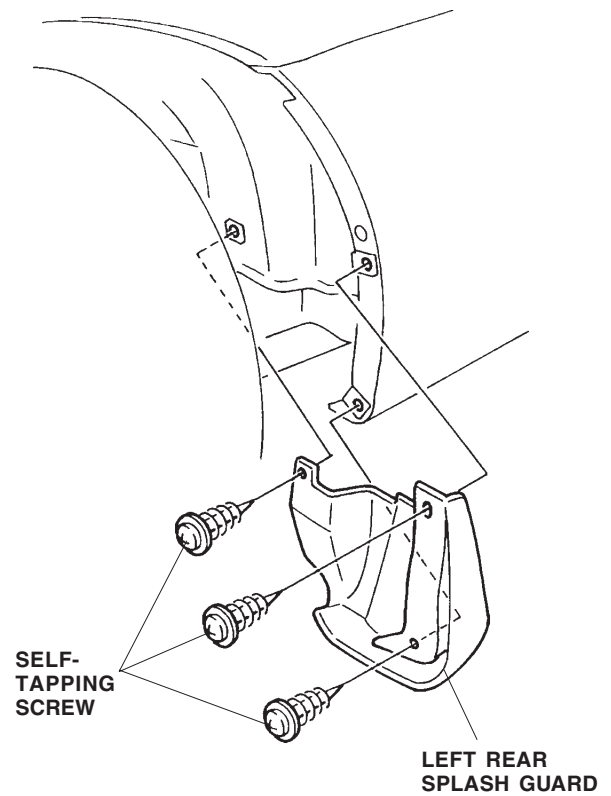

- Repeat steps 6 and 7 to install the right rear splash guard.