



INSTALLATION INSTRUCTIONS

Accessory

ROOF BOX, SHORT
P/N 08L20-TA1-100

Application

2016 ODYSSEY

Publications No.

VERSION 1

Issue Date

JULY 2015

Put this information in the glove box with the vehicle owner's manual.

PARTS LIST

Roof box

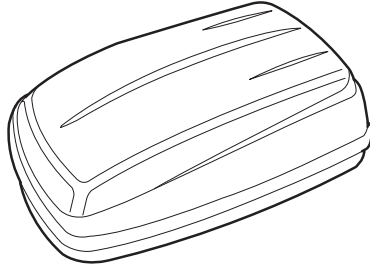

4 Brackets A

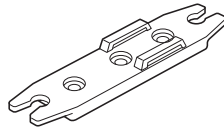

4 Brackets B

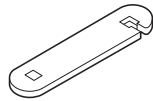

4 Plates

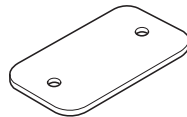

8 Knobs



8 Bolts



8 Washers



2 Straps



Seal

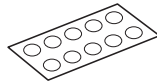

2 Keys



4 Large pads

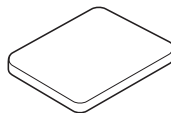

4 Small pads

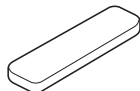

SUPPLIES REQUIRED

Isopropyl alcohol

Shop towel

INSTALLATION

NOTE:

- Be careful not to damage the finished surfaces of the body when installing the roof box.
 - The maximum load capacity for this product is 110 lb (50 kg); approximate product weight is 29 lb (13 kg).
 - Do not allow the combined weight of the accessory and cargo to exceed the carrying capacity of the roof rack.
 - Honda roof racks or crossbars are required to install the roof box.
1. Open the roof box. Attach an adhesive seal over each of the unused mounting holes on the bottom of the box. The seals will help prevent water from entering the roof box.

ROOF BOX

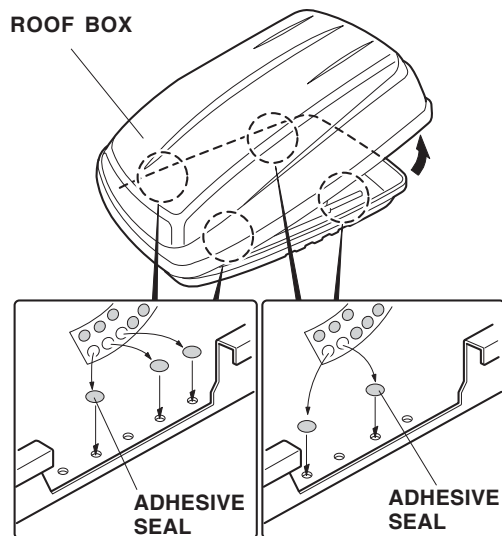

- Using isopropyl alcohol on a shop towel, clean four brackets B where the small pads will attach. Remove the adhesive backings from the small pads and attach them to the brackets B.

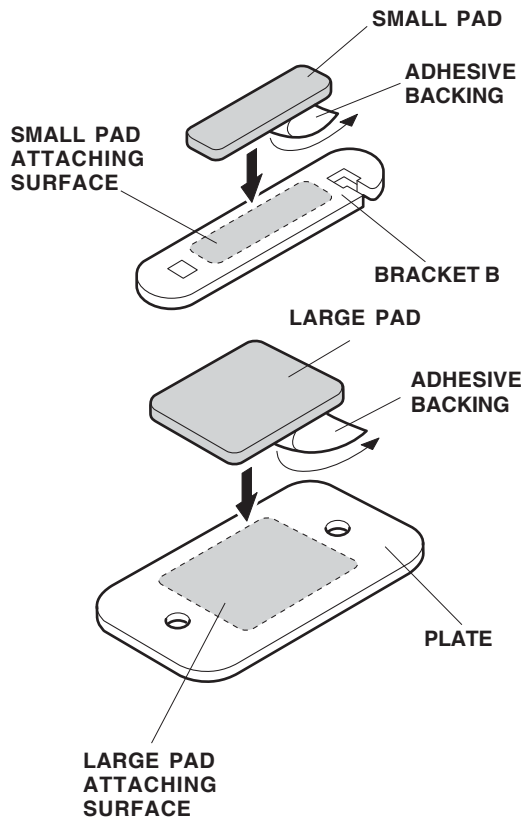

- Using isopropyl alcohol on a shop towel, clean four plates where the large pads will attach. Remove the adhesive backings from the large pads and attach them to the plates.

- At each mounting point, insert a bolt through bracket B, through the plate and into the predrilled hole in the bottom of the roof box. Install bracket B with the cutout facing the outside. Make sure the pads on the plate and bracket B are facing each other.

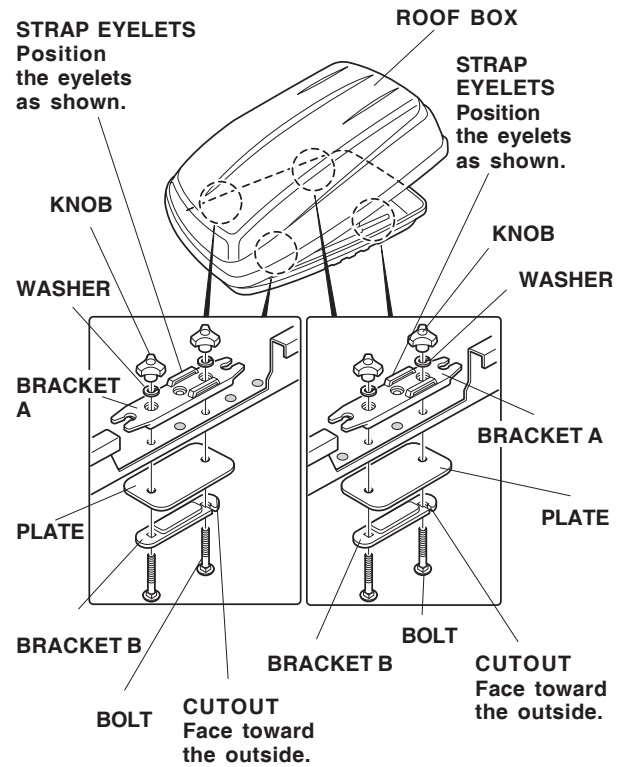

- Fit bracket A over the threads of the bolt where it protrudes through the roof box. Install a washer over the threads, and loosely install a knob. Install a second bolt the same way. Install bracket A with the right and left strap eyelets directly across from each other.

6. With the help of an assistant, carefully place the box on the crossbars. Be careful not to damage the crossbars or the roof with the hardware hanging from the bottom of the box.

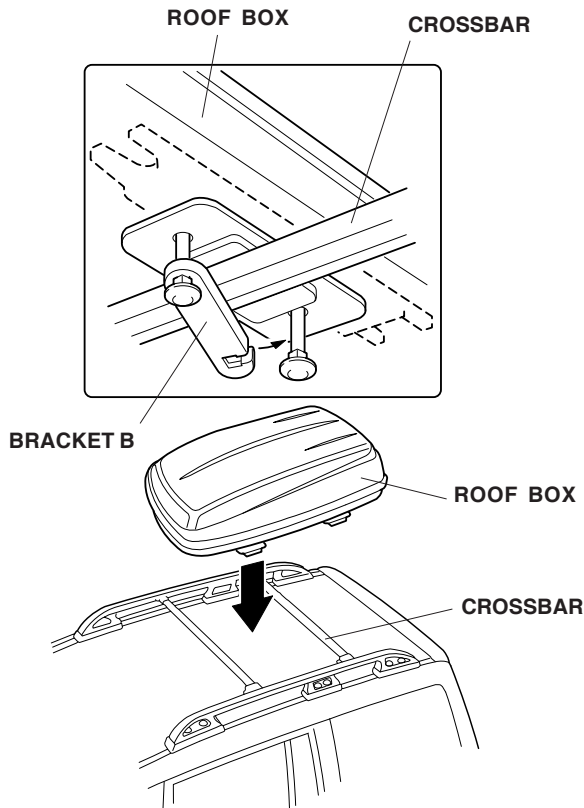

7. Arrange the plate to fit between the box and the crossbar. Swing the slotted end of bracket B around the bolt, and tighten the knobs. Fasten the box this way at all four mounting points.
- If necessary, adjust the distance between the crossbars to match the distance between the predrilled holes in the roof box. The bar spread required is 800 mm for all racks.
 - The roof box should be centered on the crossbars and parallel to the direction of travel, with the lock facing the rear of the vehicle.

8. Insert the straps through the eyelets in the brackets A, and attach the straps together.

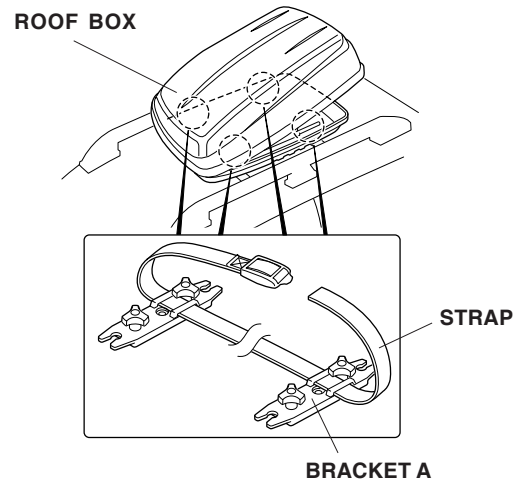

USE AND CARE

Unlocking/Locking the Roof Box:

Unlocking: Locate the key attached to the inside of the roof box. Insert the key into the lock and turn it counterclockwise to unlock. Press the center button while lifting the lid of the roof box.

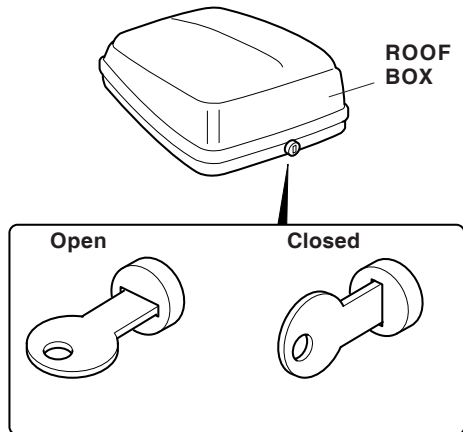

Locking: Press down on the lid. There should be an audible click. Be sure the lid is latched by attempting to lift the lid. Turn the key clockwise to lock the roof box. Remove the key while not in use. Be sure the straps are not outside of the roof box.

LOADING THE ROOF BOX

- Load weight equally on both sides to minimize imbalance. Do not overload the roof box, the maximum allowable load is 110 lb (50 kg).
- Loads must be secured with the straps to prevent them from sliding. Check the fasteners at regular intervals.