



# INSTALLATION INSTRUCTIONS

Accessory	Application	Publications No.
<b>SPLASH GUARDS</b>	<b>2011 CIVIC HYBRID</b>	<b>All 44454</b>
		Issue Date <b>AUG 2010</b>

## PARTS LIST

Left front splash guard

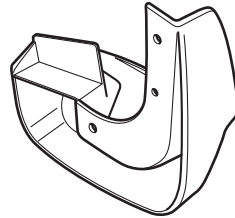

Right front splash guard

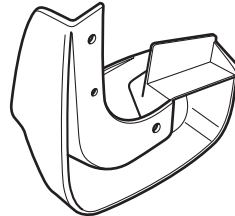

Left rear splash guard

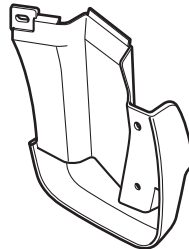

Right rear splash guard

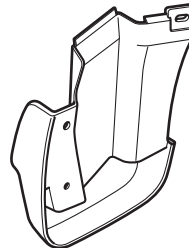

8 Self-tapping screws, 5 x 20 mm



4 Self-tapping screws, 5 x 25 mm



4 Spring nuts



2 Grommets



## TOOLS REQUIRED

- Stubby Phillips screwdriver
- Phillips screwdriver
- Clip remover
- Pushpin
- Utility knife

## INSTALLATION

### NOTE:

- These instructions show the left splash guards being installed. The same procedure applies to installing the right splash guards.
- Clean and wax the areas to be covered. Use a high-quality paste wax.

### Installing the Front Splash Guards

1. Turn the steering wheel all the way counterclockwise.
2. Using a pushpin, make small holes through the center of the three clips.

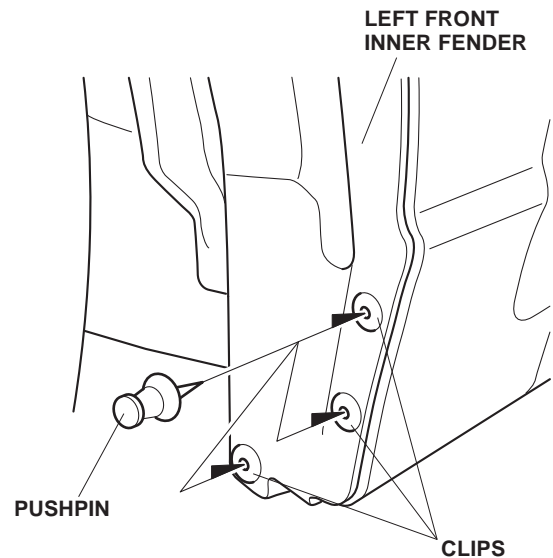

- Position the left front splash guard on the left front inner fender, and install the three 5 x 20 mm self-tapping screws. Tighten the three self-tapping screws in the order shown.

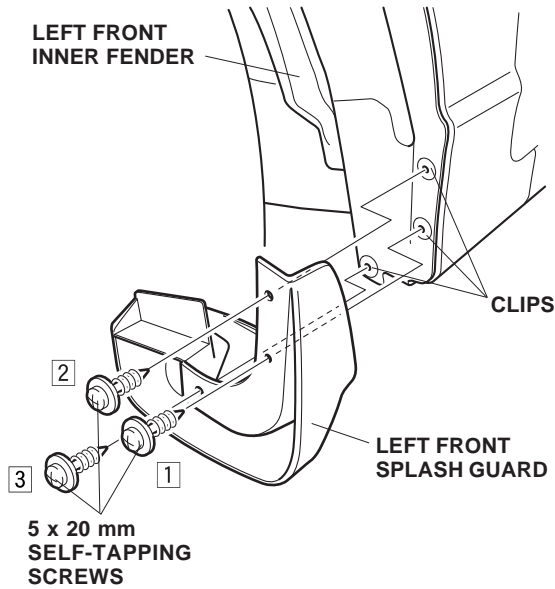

- Turn the steering wheel all the way clockwise, and repeat steps 2 and 3 to install the right front splash guard.

### Installing the Rear Splash Guards

- If equipped, remove and discard the left rear inner fender (two self-tapping screws and one clip).

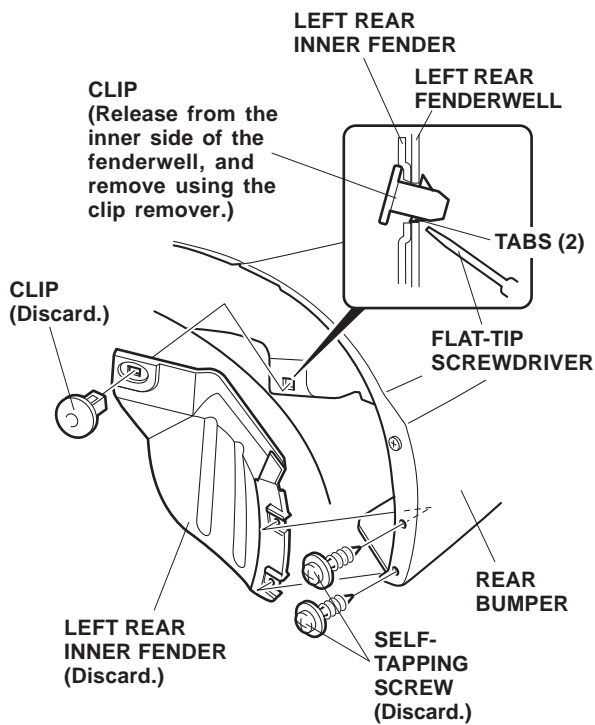

- Install one grommet into the hole in the left rear fenderwell. Slide two spring nuts over the holes in the rear bumper.

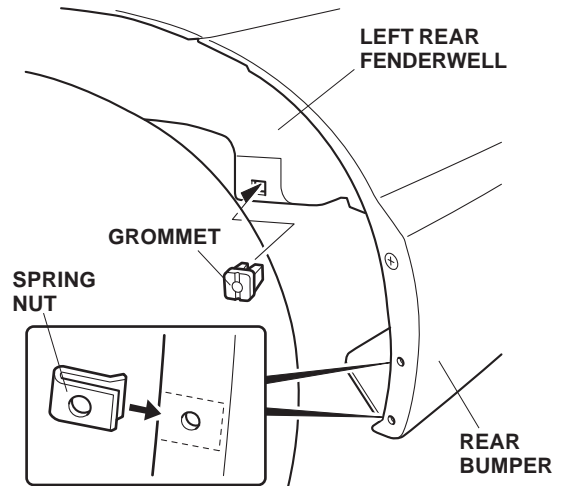

7. Position the left rear splash guard on the left rear fenderwell and rear bumper, then install the two 5 x 25 mm self-tapping screws and one 5 x 20 mm self-tapping screw. Tighten the three self-tapping screws in the order shown. Cut off any excessive undercoat material with a utility knife.

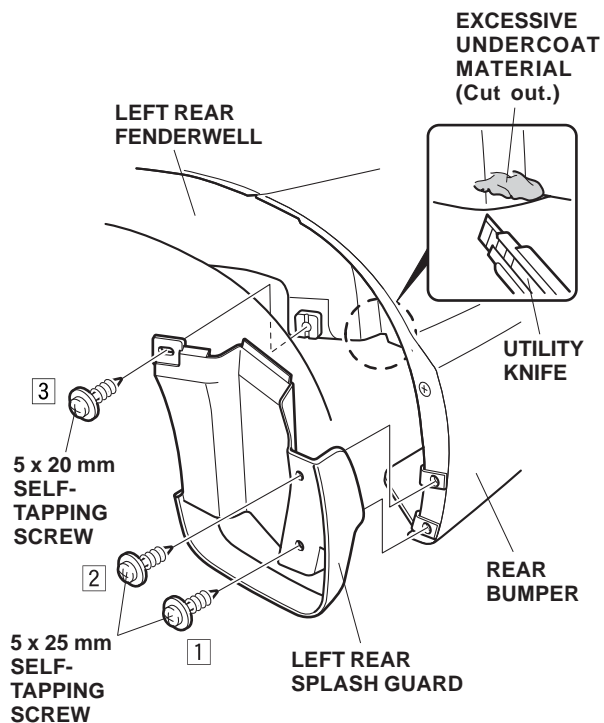

8. Repeat steps 5 through 7 to install the right rear splash guard.