



INSTALLATION INSTRUCTIONS

Accessory

SECURITY SYSTEM

Application

2010 RIDGELINE

Publications No.

All 42153

Issue Date

AUG 2009

PARTS LIST

**Security System Attachment Kit:
P/N 08E55-SJC-100**

Unit bracket

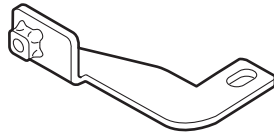

Security harness

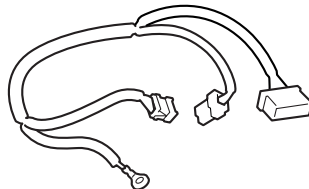

10 Wire ties

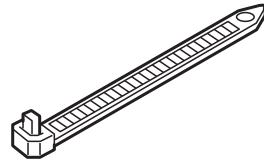

Fuse (2 A)

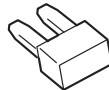

LED



2-pin Connector

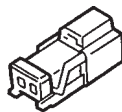

2 Cushion tapes

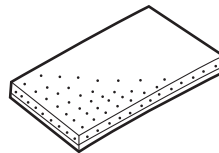

Fuse label

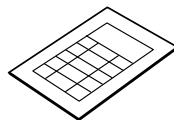

Flange bolt



Information manual



**Security System Kit (sold separately)
P/N 08E51-SHJ-100**

Security unit

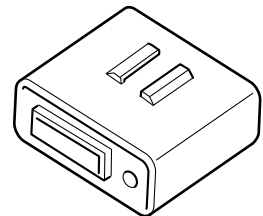

Security label

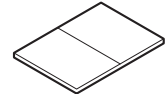

Microphone

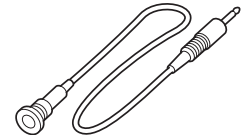

TOOL AND SUPPLIES REQUIRED

#2 Phillips screwdriver

Felt-tip pen

8 mm and 10 mm Socket

Ratchet

3 mm, 6 mm, and 8 mm Drill bits

Eye protection (face shield, safety goggles, etc.)

File

Diagonal cutters

Tape measure

Drill

Isopropyl alcohol

Shop towel

Scissors

Illustration of the Security System Installed on the Vehicle

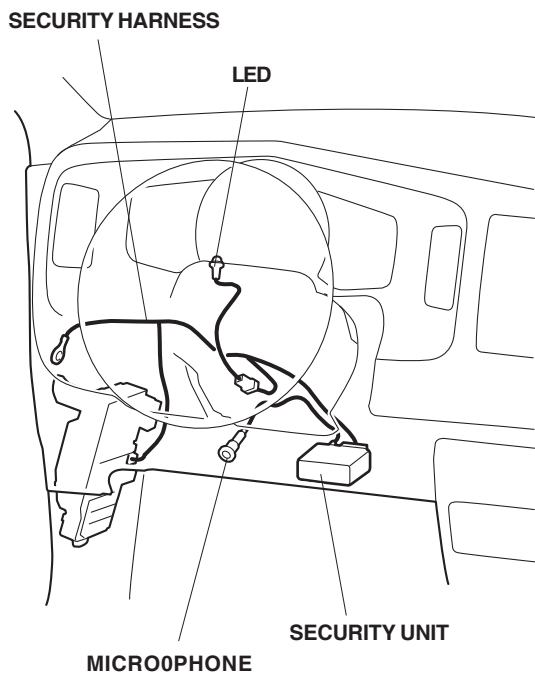

INSTALLATION

Customer Information: The information in this installation instruction is intended for use only by skilled technicians who have the proper tools, equipment, and training to correctly and safely add equipment to your vehicle. These procedures should not be attempted by "do-it-yourselfers."

1. Make sure you have the anti-theft code for the radio, then write down the radio station presets.
2. Disconnect the negative cable from the battery.

Installing the Microphone

3. Remove the left dashboard side cover (seven clips).

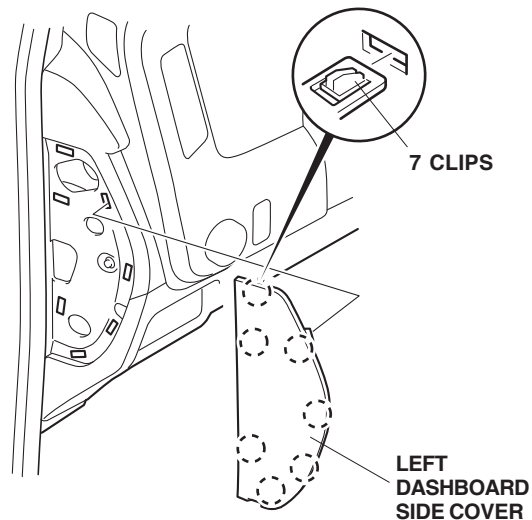

4. Remove the driver's dashboard lower cover:
 - Remove the one self-tapping screw.
 - Release the nine clips, and pull out the driver's dashboard lower cover.
 - Unplug the vehicle connectors, and remove the lower cover.

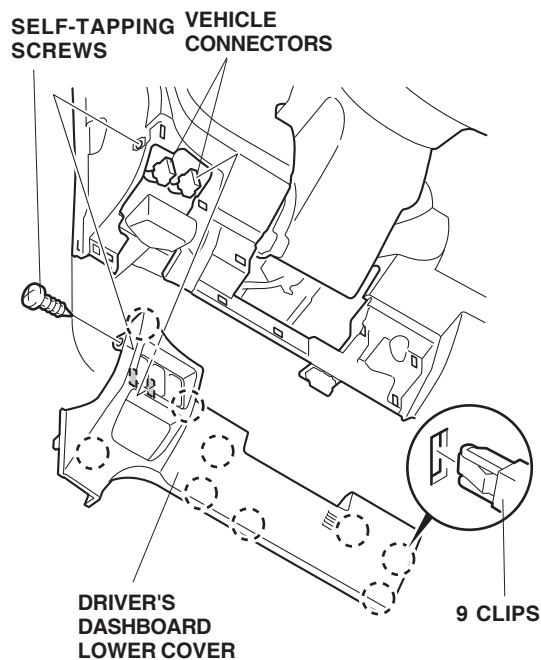

- Using a tape measure and felt-tip pen, measure and mark the driver's dashboard lower cover.

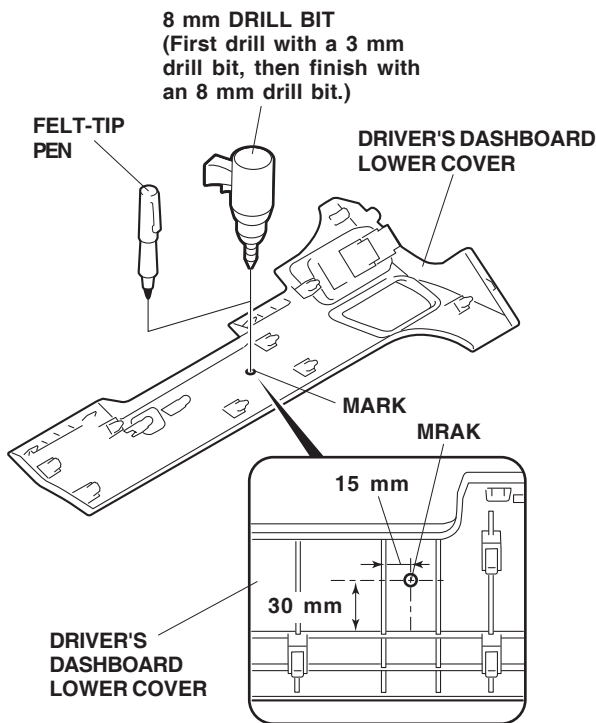

- While wearing eye protection, drill an 8 mm hole through the mark. Remove all burrs. First drill with a 3 mm drill bit, then finish with an 8 mm drill bit.
- Route the microphone jack through the hole you just drilled, and secure the microphone in the cover.

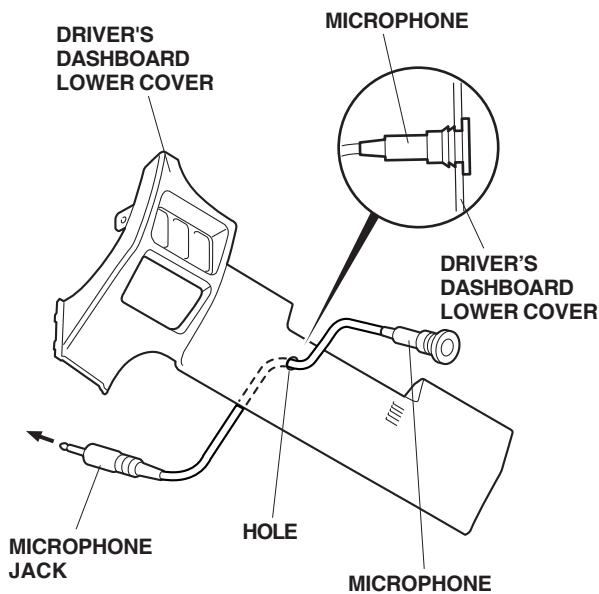

Installing the LED

- Remove the upper and lower steering column covers:
 - Carefully pry up on the six retaining tabs to remove the upper steering column cover.
 - Remove the shift lock release cover (four retaining tabs). Insert the ignition key into the shift lock release hole, and move the shift lever to the "N" position while pressing down on the key.
 - Remove the key, and lift up on the upper steering column cover. Pull the cover out toward you, and remove it by lowering the shift lever to the "1" position.
 - Remove the two self-tapping screws and one screw, and remove the lower steering column cover.

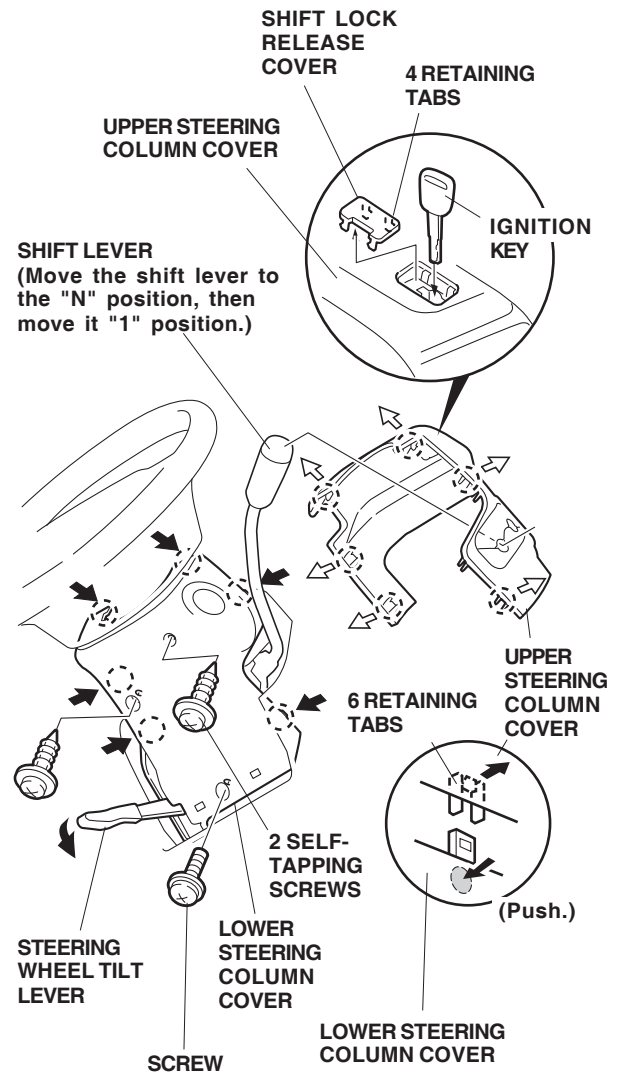

- Using a tape measure and felt-tip pen, measure and mark the steering column upper cover.

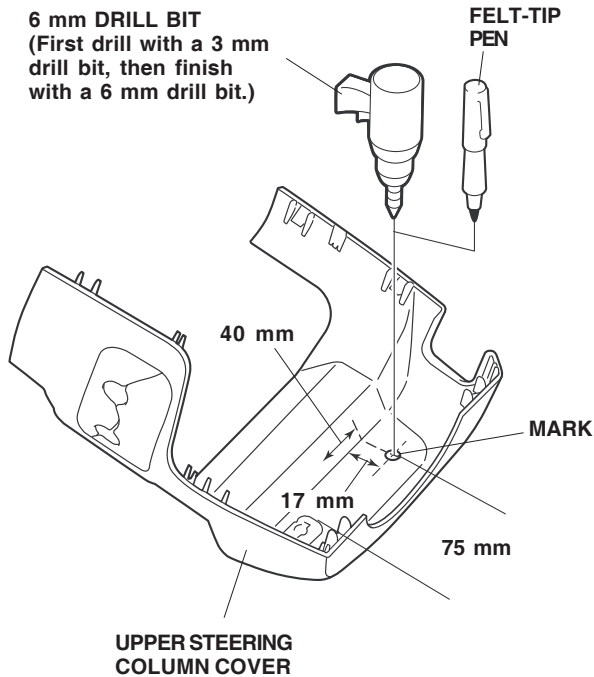

- While wearing eye protection, drill a 6 mm hole through the mark. First drill with a 3 mm drill bit, then finish with a 6 mm drill bit. Remove all burrs.
- Route the terminal ends of the LED through the hole you just drilled in the cover, and secure the LED in the cover.

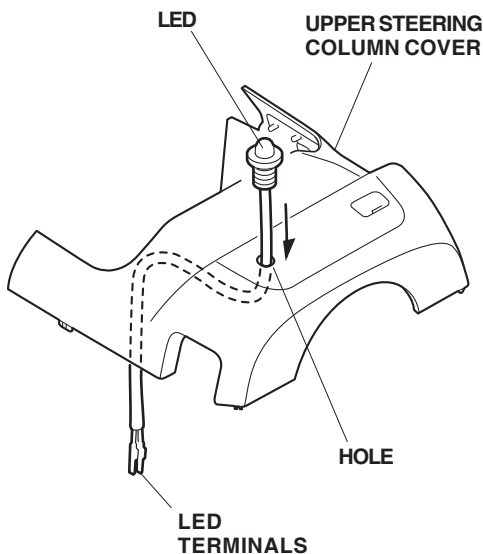

- Get the 2-pin connector from the kit. Firmly push the LED terminals into the 2-pin connector until they click into position, then lower the lock.

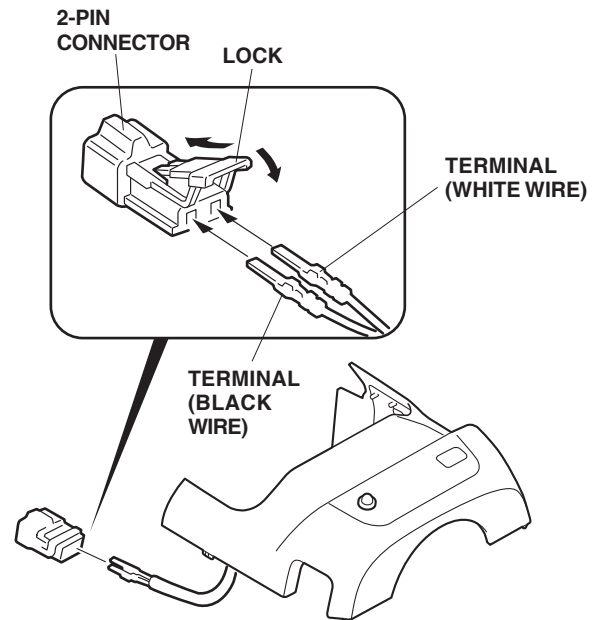

Routing the Security Harness

- Push the security harness 6-pin connector into the fuse box 6-pin connector.

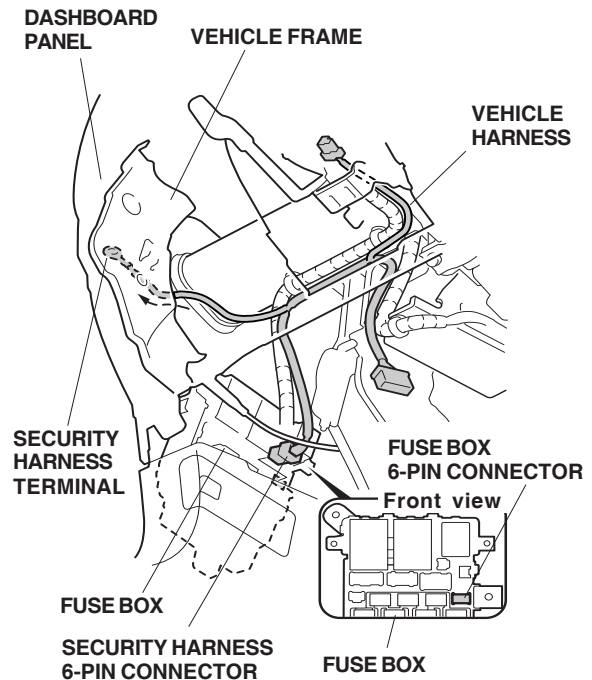

- Route the security harness 2-pin connector along the vehicle harness, and route the security harness terminal between the vehicle frame and dashboard panel.

- Remove the vehicle ground bolt, and attach the security harness ground terminal using this bolt.

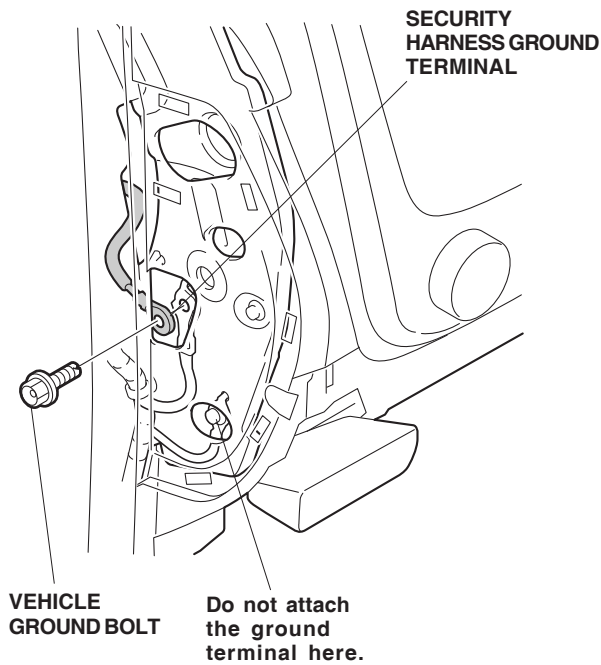

- Secure the security harness to the gauge harness with four wire ties in the area shown.

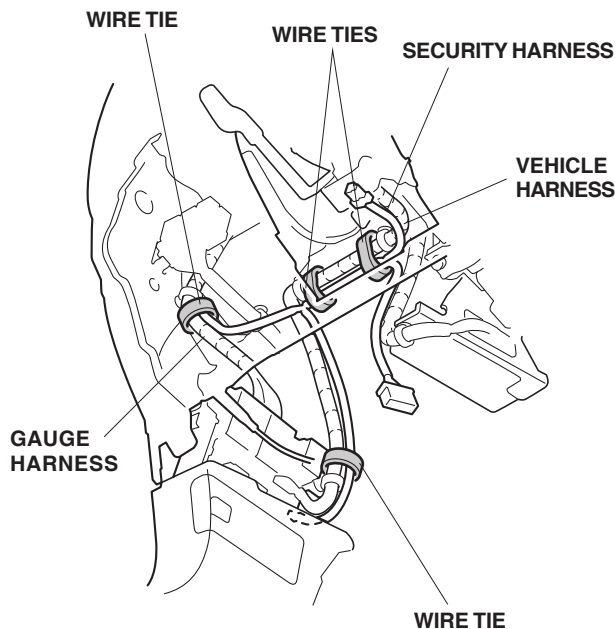

- Position the upper steering column cover above the steering column, and plug the security harness 2-pin connector into the LED 2-pin connector.

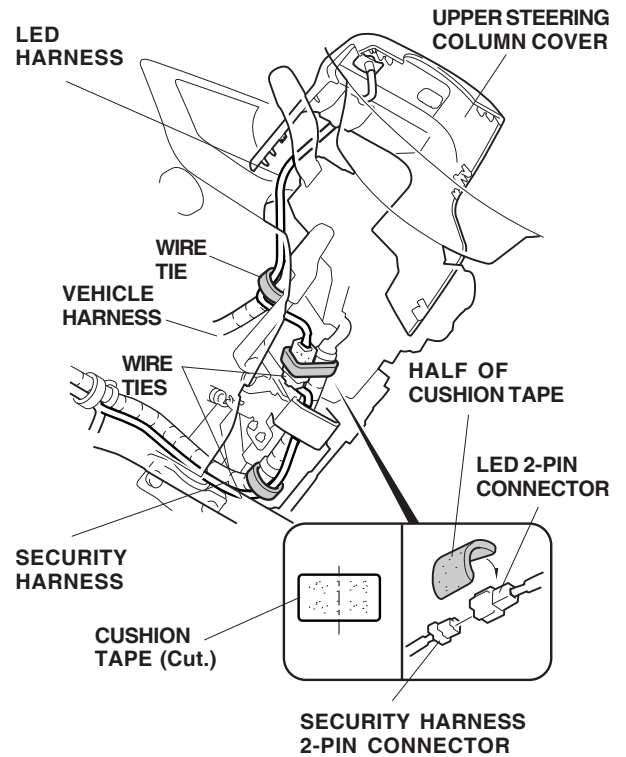

- Using scissors, cut one cushion tape in half. Wrap the cut cushion tape around the connector, and secure the LED terminal and the connector to the vehicle harness with three wire ties.
- Reattach the steering column covers.

Installing the Security Unit

- Get the security unit and the unit bracket. Using scissors, cut a 15 x 50 mm piece of cushion tape. Attach the cut piece of cushion tape to the security unit at the location shown.

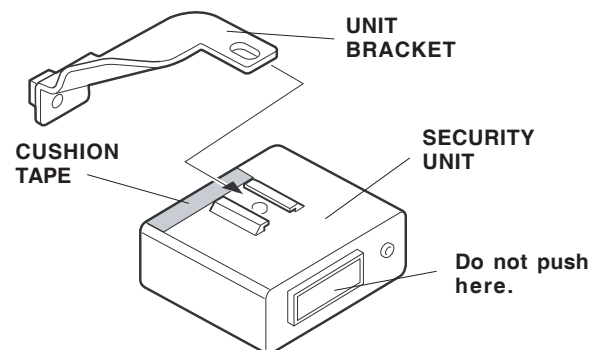

- Insert the unit bracket into the security unit. Do not push at the connector area.

25. Using isopropyl alcohol on a shop towel, clean the area where the cushion tape will attach. Using scissors, cut a slit in the remaining half of cushion tape, and attach it to the security unit as shown.

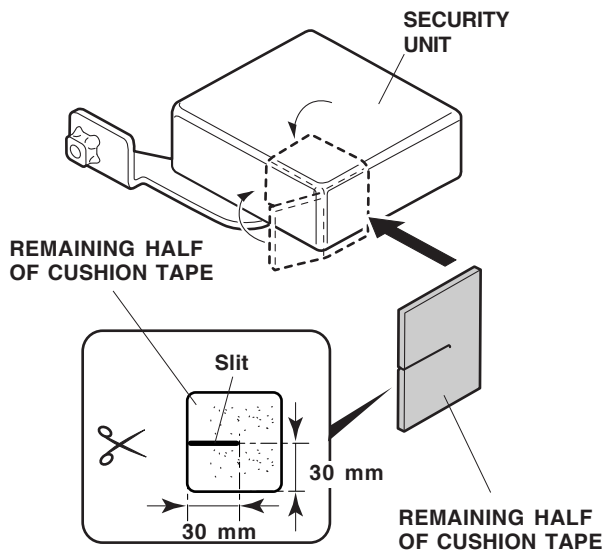

26. Under the dash, install the security bracket to the vehicle frame with one flange bolt provided.

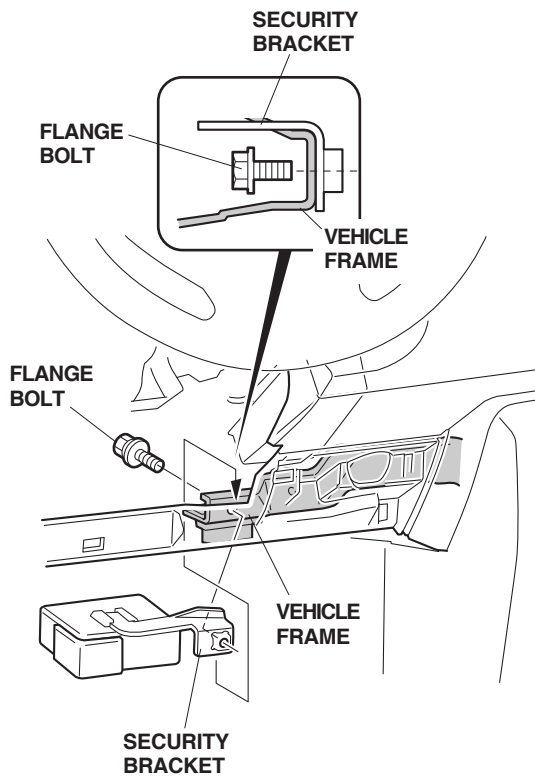

- If the vehicle is equipped with backup sensors;* remove the wire tie that fastens the backup sensor harness. Wrap one cushion tape around the backup sensor harness, and secure the backup sensor harness to the unit bracket with the wire tie you removed.

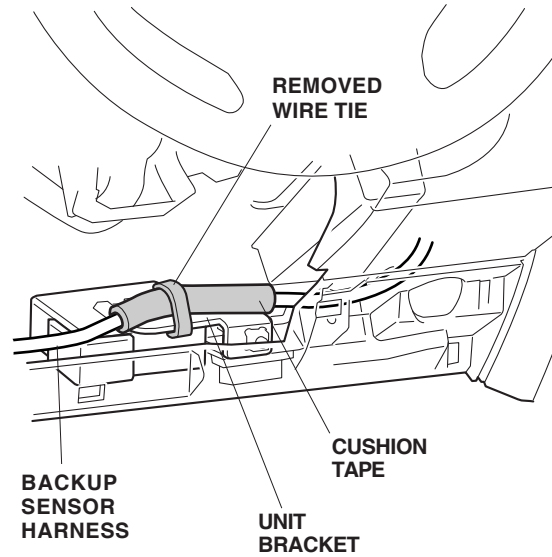

27. Reinstall the dashboard lower cover. Plug the security harness 18-pin connector and the microphone jack into the security unit.

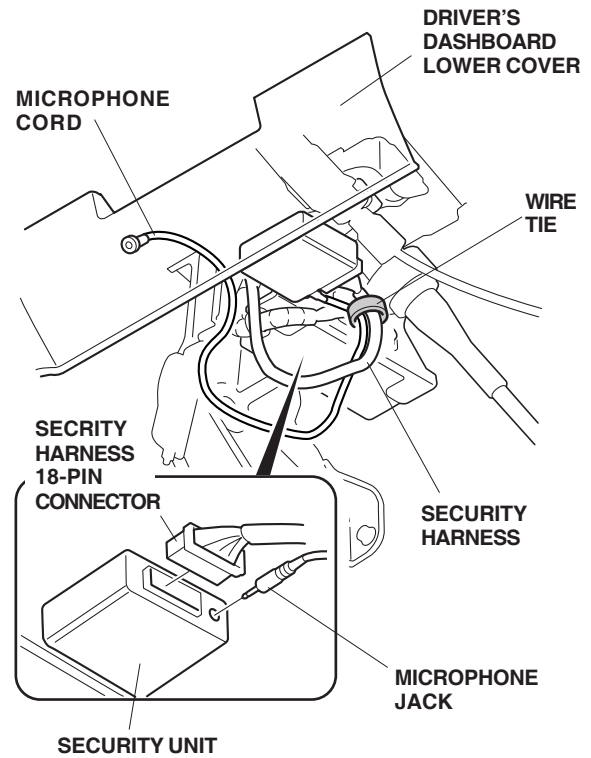

28. Fold the security harness and microphone wire, and secure it with one wire tie so that there is no tension applied to the microphone jack.

29. Fold the excess length of the microphone wire, and secure it to the vehicle harness with two wire ties.

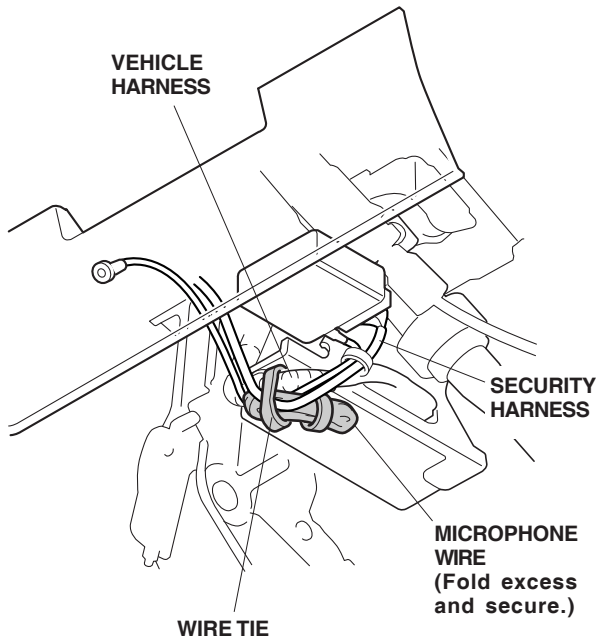

Installing the Fuse

30. Slide the fuse box cover forward, and remove it. Install the 2 A fuse into the No.33 slot of the fuse box.

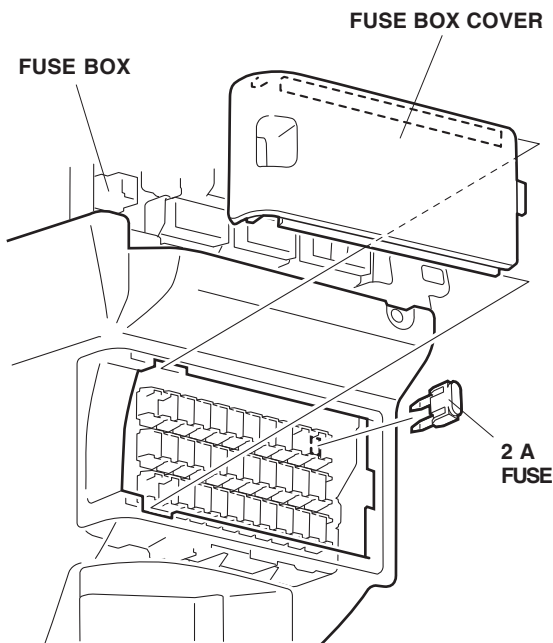

31. Attach the fuse label (OPTION FUSE 2 A) over the No.33 slot on the inside of the fuse box cover.

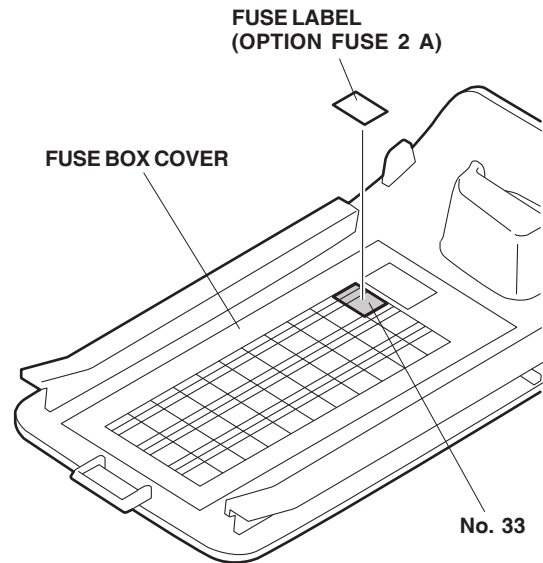

32. Check that all wire harnesses are routed properly and all connectors are plugged in.
32. Reinstall all removed parts.
34. Reconnect the negative cable to the battery.
35. Enter the customer's radio anti-theft code, and reset the radio station presets.
36. Reset the clock.
37. Check the operation of the security system according to the Security System Information manual.

NOTE: Whenever the battery is disconnected, the driver's window AUTO function is disabled.

38. Start the engine. Push down on the driver's window switch until the window is fully open.
39. Pull up on the driver's window switch fully to close the window completely, then hold the switch for 2 seconds or more.
40. Test the window AUTO function.
41. Install one security system window sticker to the lower right corner of the driver's window and one sticker to the lower left corner of the passenger's window.