



INSTALLATION INSTRUCTIONS

Accessory
MOTORCYCLE WHEEL GUIDE
P/N 08L07-SJC-100

Application
2010 RIDGELINE

Publications No.
All 42146
Issue Date
AUG 2009

Put this information in the glove box with the vehicle owner's manual.

PARTS LIST

Front wheel guide

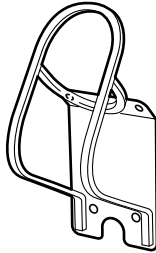

2 Plates

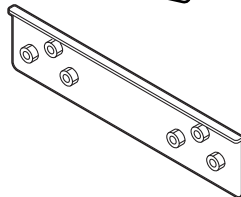

8 Hex screws

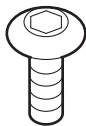

4 Washers



8 Collars



TOOLS AND SUPPLIES REQUIRED

Ratchet

4 mm Hex socket

Drill

3 mm and 9 mm Drill bits

Round file

Eye protection (face shield, safety goggles, etc.)

T50 Torx socket

T40 Torx socket

Center punch

INSTALLATION

Customer Information: The information in this installation instruction is intended for use only by skilled technicians who have the proper tools, equipment, and training to correctly and safely add equipment to your vehicle. These procedures should not be attempted by "do-it-yourselfers."

NOTE:

- Be careful not to damage the body finish.
 - Determine the location of the wheel guide. One or more wheel guides can be installed in three different locations.
1. Remove the left front upper tie-down hook (two torx bolts). Remove the right front upper tie-down hook (two torx bolts).

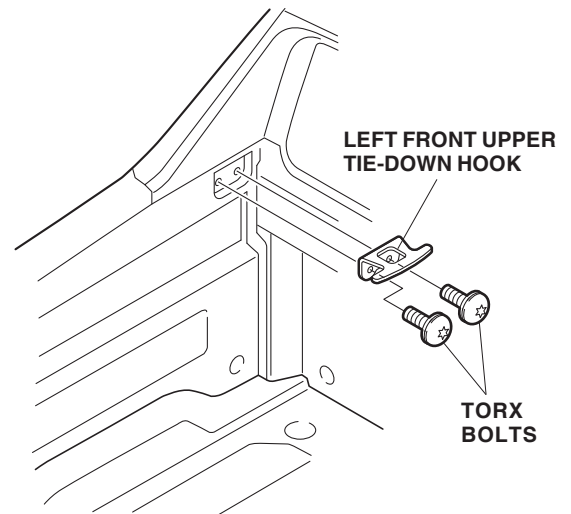

- Remove the front bed panel (six torx bolts).

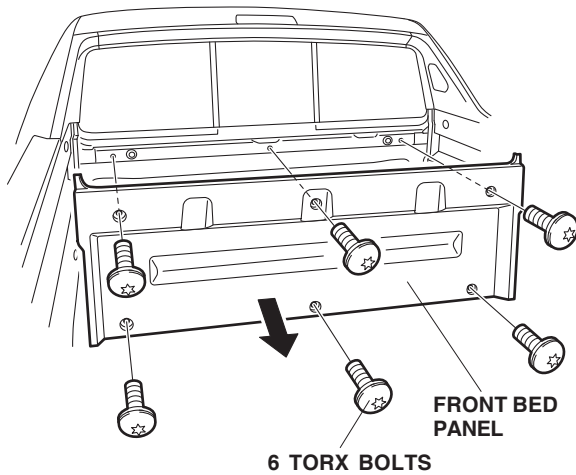

Installing one wheel guide in the center position

- Center punch the eight marked locations on the front bed panel. While wearing eye protection, drill a 3 mm hole through each of the eight marked locations.

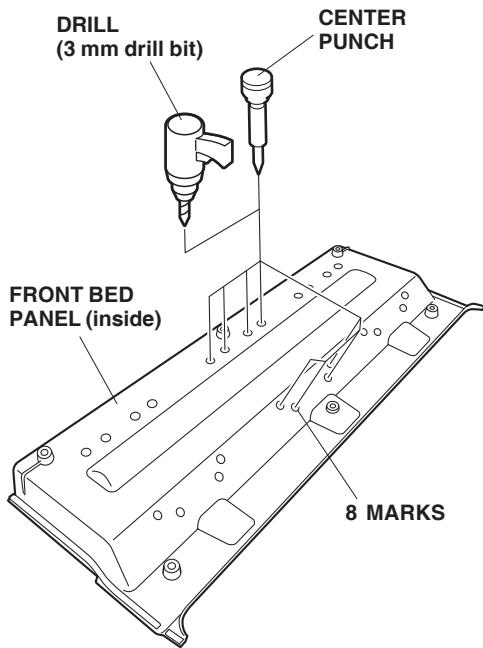

- While wearing eye protection, enlarge the eight holes to 9 mm from the outer surface side of the front bed panel. Remove all burrs from the edges of the holes with a file.

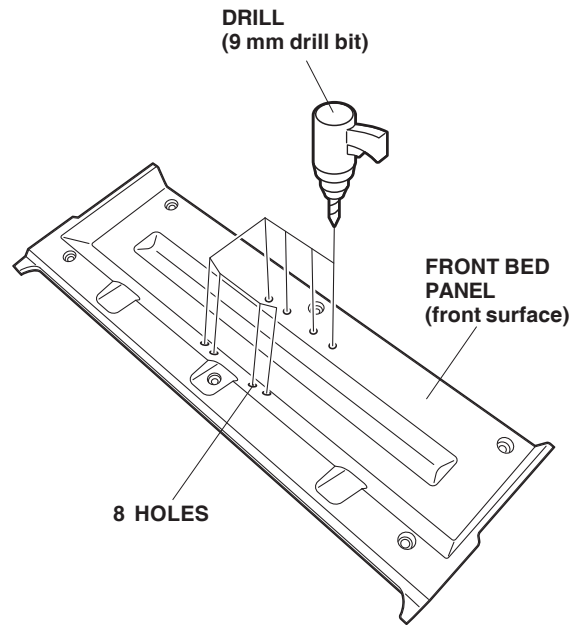

- Position the front wheel guide on the front bed panel, and install two plates, eight collars, four washers, and eight screws as shown.

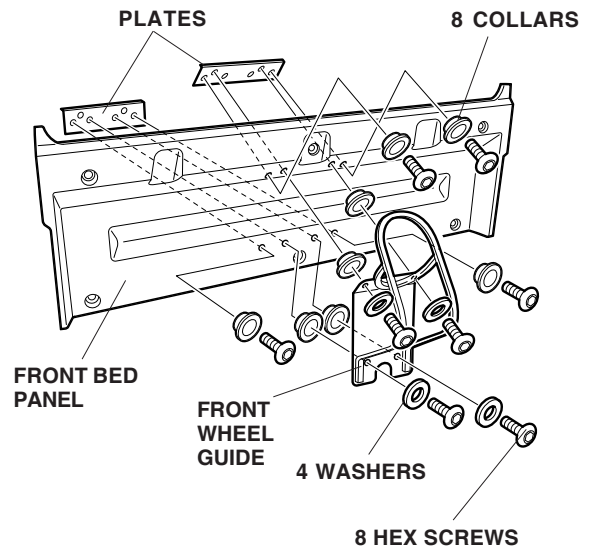

- Reinstall the front bed panel and the upper tie-down hooks.

Installing Wheel Guides in the Outer Positions (Two kits are required)

- Center punch the 16 marked locations on the front bed panel. While wearing eye protection, drill a 3 mm hole through each of the 16 marked locations. Enlarge the 16 holes to 9 mm. Remove all burrs from the edges of the holes with a file.

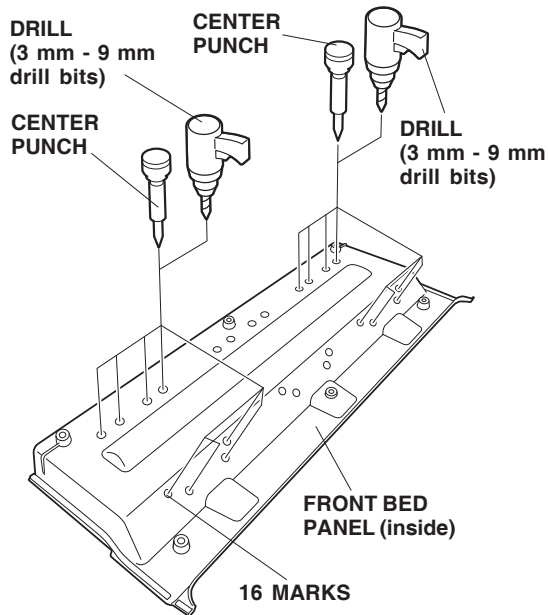

- Position the two front wheel guides on the front bed panel, and install four plates, sixteen collars, eight washers, and sixteen screws as shown.

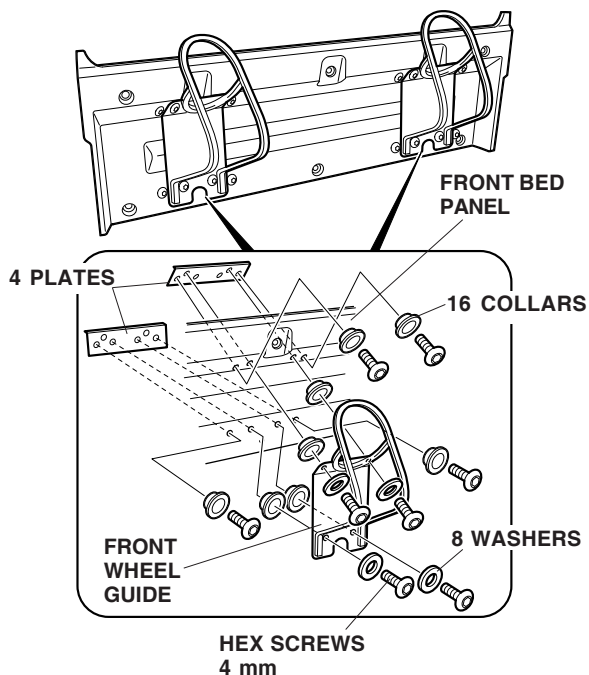

- Reinstall the front bed panel and the upper tie-down hooks.

USE AND CARE

- Place the front wheel in the front wheel guide. Secure the bike with three tie-downs (commercially available) and attach the tie-downs to the tie-down hooks in the bed.

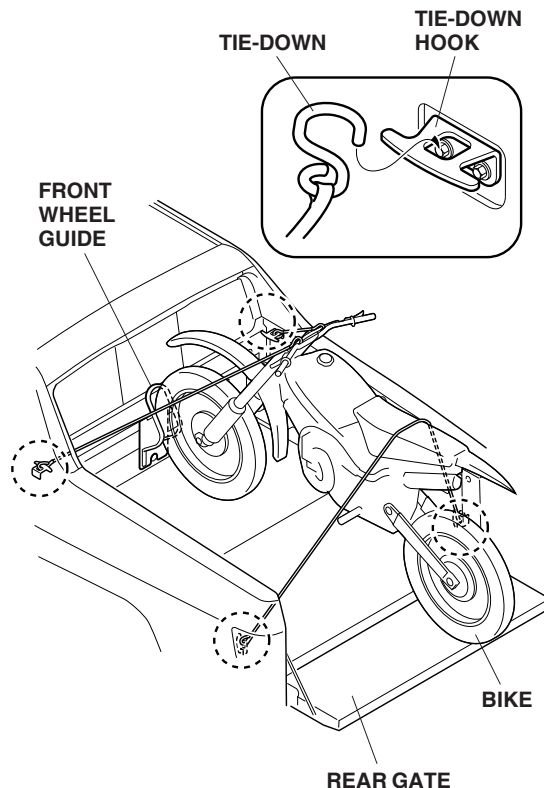

NOTE: Do not hook tie-downs to the front wheel guide.

