



# INSTALLATION INSTRUCTIONS

Accessory  
REAR SEAT COVERS

Application  
2010 ELEMENT  
(DOG FRIENDLY PACKAGE)

Publications No.  
All 42744  
Issue Date  
NOV 2009

Put this information in the glove box with the vehicle owner's manual.

## PARTS LIST

Right rear seat cover set

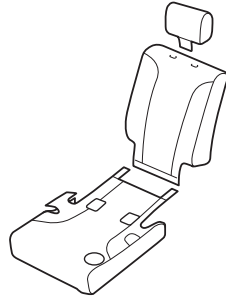

Left rear seat cover set

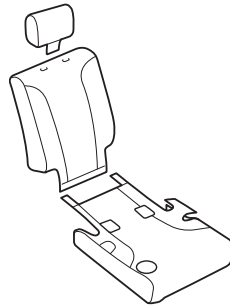

## INSTALLATION

NOTE: Be careful not to damage the seats.

### Installing the Headrest Cover

1. While pressing on the headrest guide knob, pull the headrest upward to remove it.

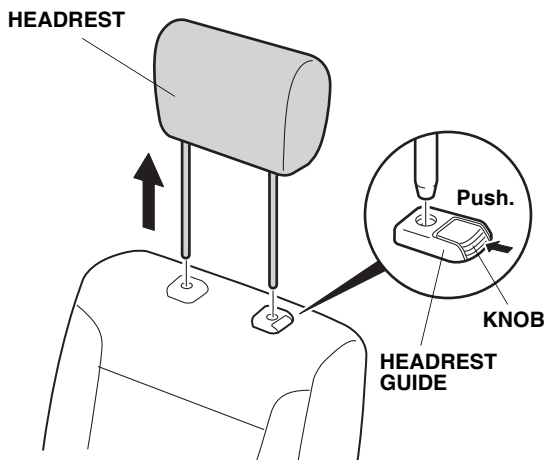

2. Fit the headrest cover over the headrest, and adjust it so that it fits smoothly over the edges. Secure the hook-and-loop fastener.

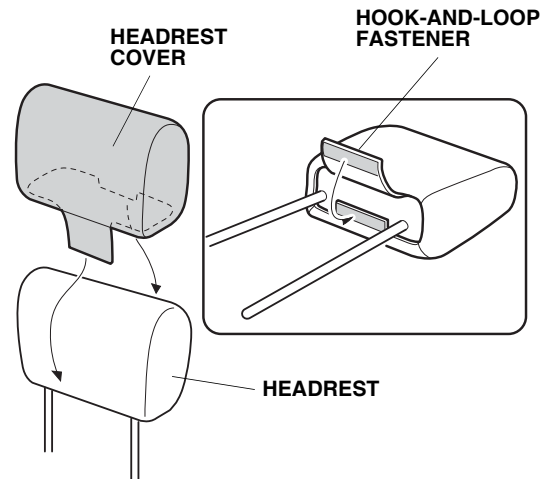

### Installing the Seat-back Cover

3. Fit the seat-back cover over the seat-back, and adjust it so that it fits smoothly over the edges. Secure the hook-and-loop fastener, and close the zipper.

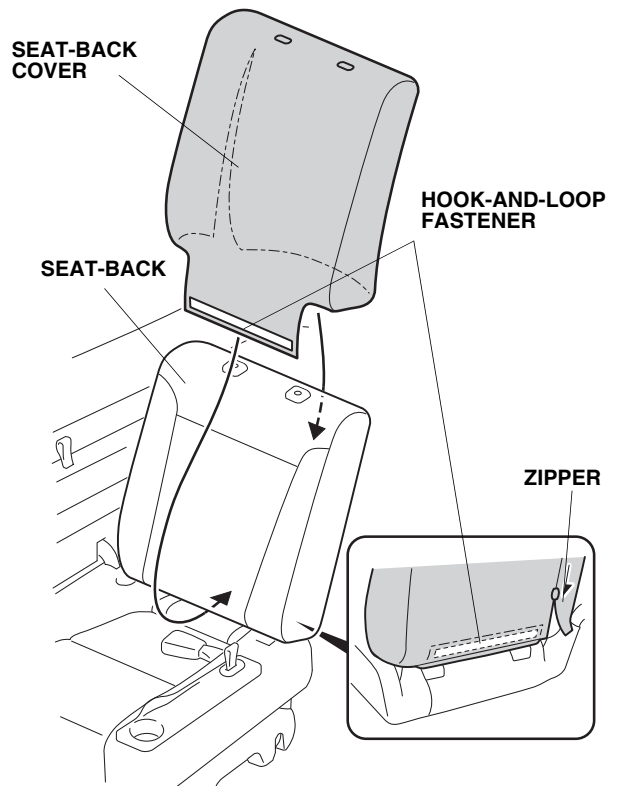

## Installing the Seat Cushion Cover

4. Fit the seat cushion cover over the seat cushion, and adjust it so that it fits smoothly over the edges.

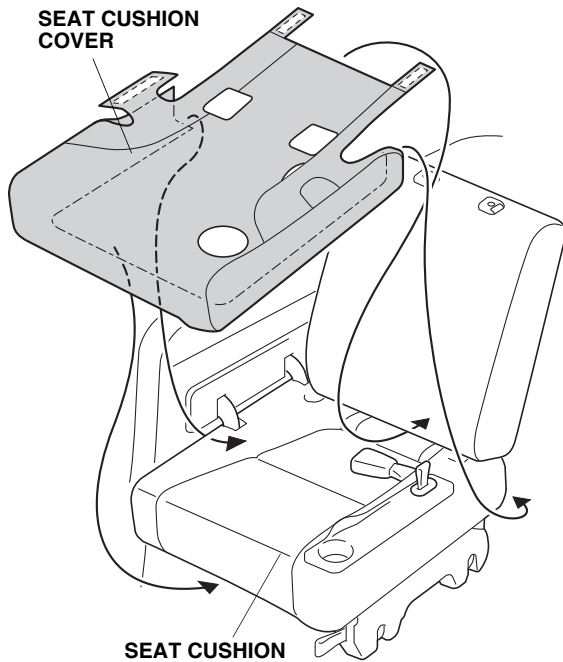

5. Lift the seat and secure it to the side with the seat strap.

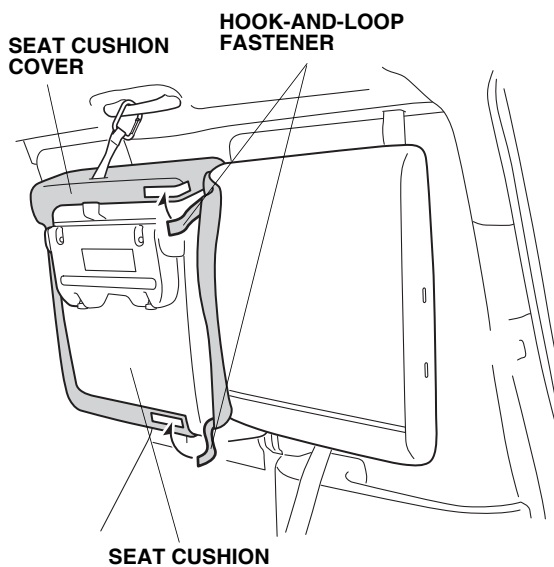

6. Secure the seat cover with the hook-and-loop fasteners.
7. Return the seat to its original position.
8. Reinstall the headrest.
9. Repeat steps 1 thru 8 to install the left rear seat cover.

## USE AND CARE

To clean the seat covers, follow the instructions described on the label sewn to the side of the seat-back cover.