



INSTALLATION INSTRUCTIONS

Accessory
**DOG FRIENDLY
EXTERIOR EMBLEMS**

Application
**2010 ELEMENT
(DOG FRIENDLY PACKAGE)**

Publications No.
All 42738
Issue Date
NOV 2009

PARTS LIST

Tailgate emblem



Tailgate template

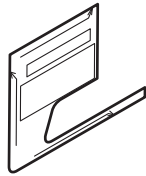

2 Fender emblems



Fender template

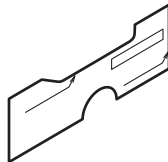

3 Alcohol wipes

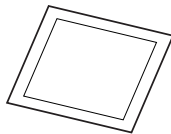

TOOLS AND SUPPLIES REQUIRED

Masking tape

INSTALLATION

NOTE:

- Be careful not to damage the body paint finish.
- Before attaching, thoroughly clean the areas where the emblems will attach.
- This emblem kit should be installed only if the ambient air temperature is 15°C (60°F) or above.
- After attaching, hold the emblems firmly against the vehicle panels with palm of your hand.
- To allow the adhesive to cure, do not wash the vehicle for 24 hours.
- This instruction shows the left fender emblem being installed. Repeat this procedure to install the other fender emblem on the right fender of the vehicle.

Installing the Tailgate Emblem

1. Place the tailgate template on the tailgate panel in the location shown, and tape the template to the tailgate with strips of masking tape.

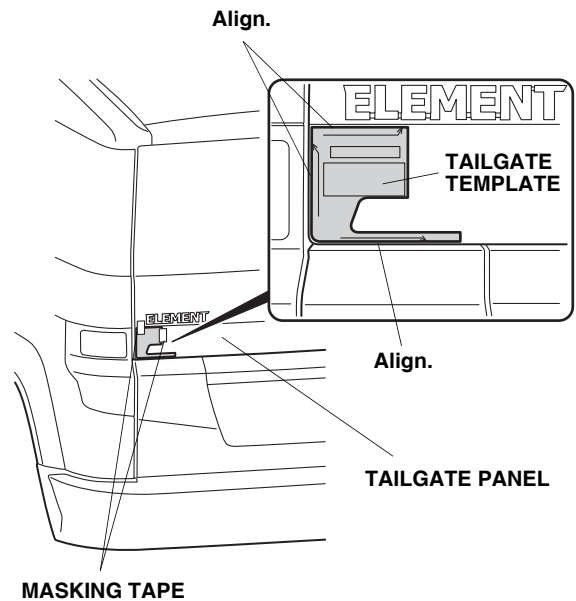

2. Get the tailgate emblem. Peel back 1½ - 2 inches of adhesive backing from the emblem, and tape it to the front of the emblem with a strip of masking tape.

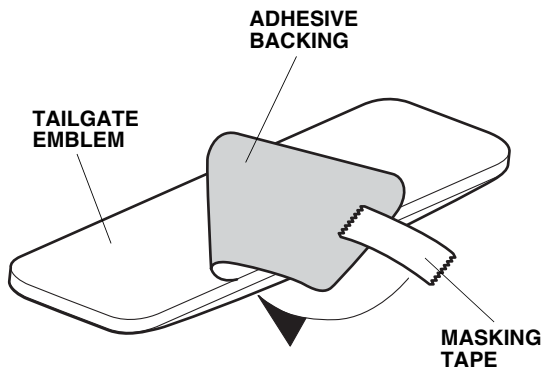

3. Using an alcohol wipe, thoroughly clean the tailgate area where the emblem will attach.

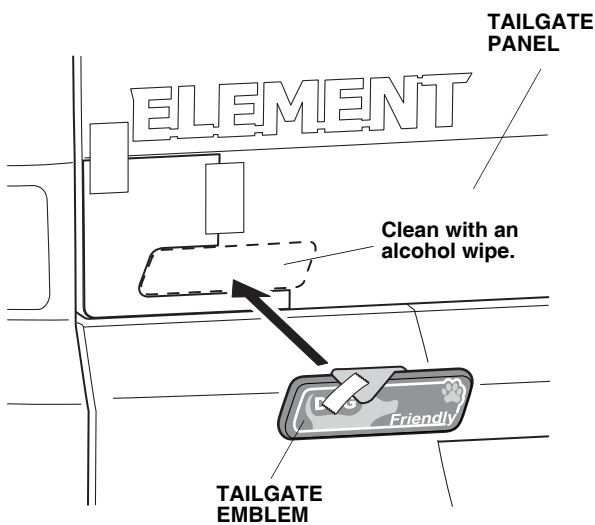

4. Place the tailgate emblem on the tailgate panel, and fit the emblem into the template as shown.

5. Remove the tailgate template. While applying light pressure on the tailgate emblem, carefully remove the adhesive backing.

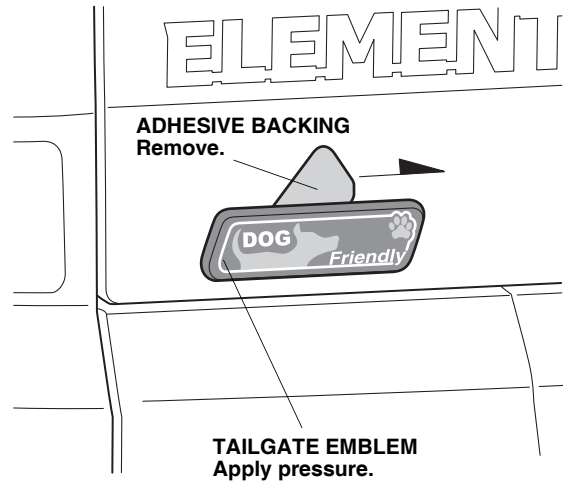

6. Press and hold the emblem against the body with the palm of your hand for 30 seconds.

Installing the Front Fender Emblems

7. Locate the reflector on the left front fender. Place the fender template on the left front fender in the location shown, and tape the template to the fender with strips of masking tape.

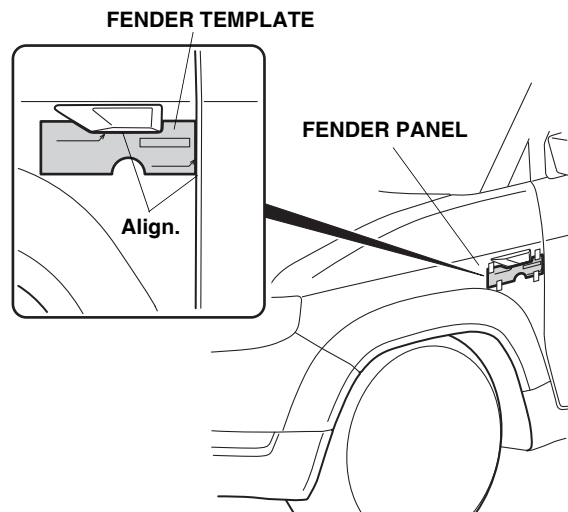

8. Remove the adhesive backing from the fender emblem.

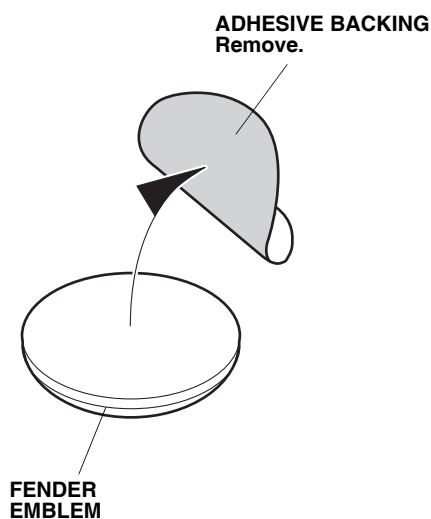

9. Using an alcohol wipe, thoroughly clean the area where the fender emblem will attach.

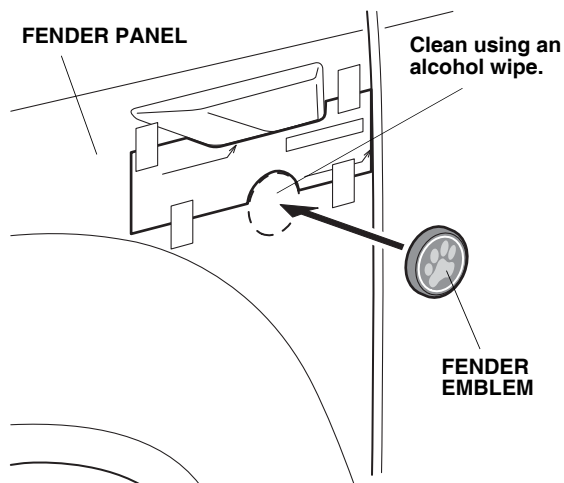

10. Place the fender emblem on the fender panel and align top edge of the emblem with the lower edge of the fender template.

11. Press and hold the emblem against the body with the palm of your hand for 30 seconds. Remove the template.

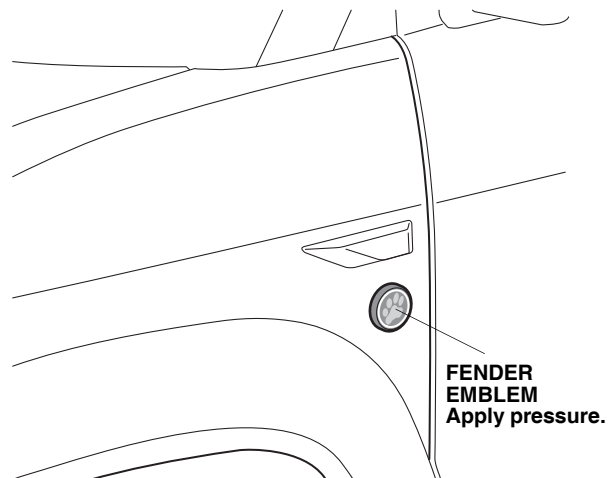

12. Turn the template over, and repeat steps 7 thru 11 to install the other fender emblem on the right side of the vehicle.