



INSTALLATION INSTRUCTIONS

Accessory
CIGARETTE LIGHTER
P/N 08U96-S9A-101

Application
2008 CR-V

Publications No.
All 37476
Issue Date
AUG 2007

PARTS LIST

Cigarette lighter

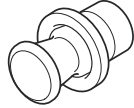

Socket

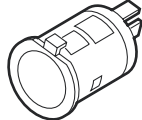

Ring



Fuse label

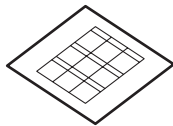

TOOLS AND SUPPLIES REQUIRED

Shop towel

Small flat-tip screwdriver

INSTALLATION

Customer Information: The information in this installation instruction is intended for use only by skilled technicians who have the proper tools, equipment, and training to correctly and safely add equipment to your vehicle. These procedures should not be attempted by "do-it-yourselfers."

1. Make sure you have the anti-theft code for the radio, then write down the radio station presets.
2. Disconnect the negative cable from the battery.

3. Remove the driver's dashboard undercover (turn the knob clockwise, and release one pin and one clip).

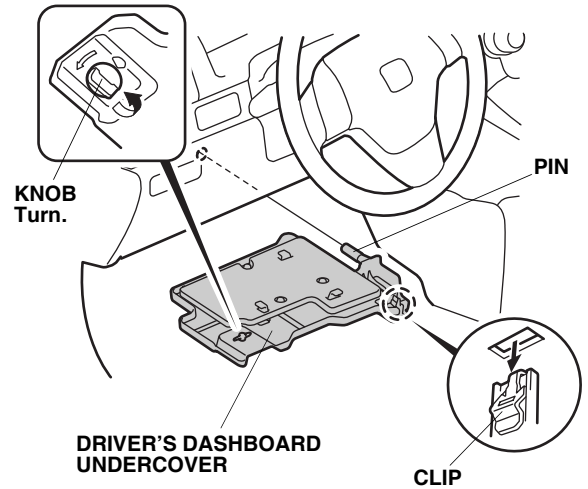

4. Remove the left center console cover (two clips and three clips).

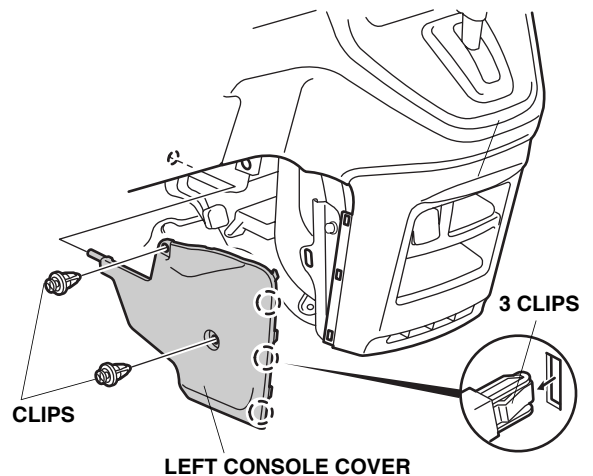

- Open the accessory socket cover. Using a shop towel around a small flat-tip screwdriver, gently pry on the accessory socket to pop it out. Disconnect the vehicle 2-pin connector from the accessory socket.

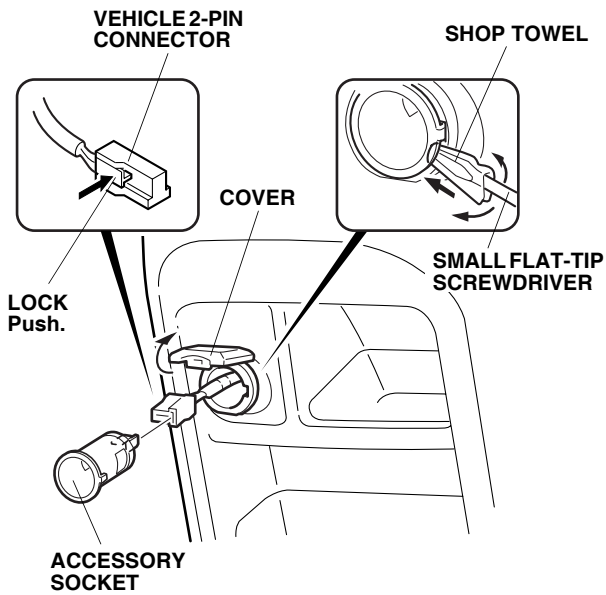

- Pull out the accessory socket case from the center lower cover.

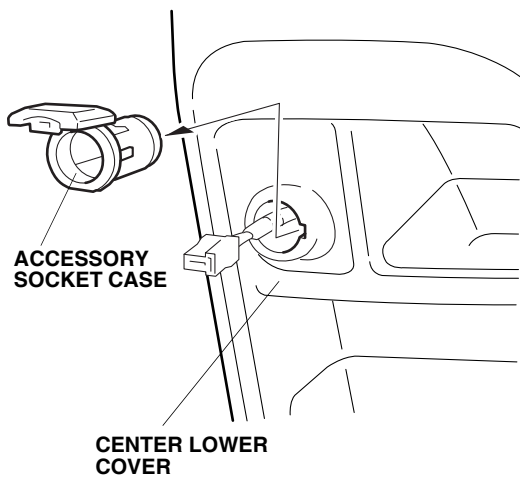

- Slide the ring into the hole in the center lower cover in the direction shown.

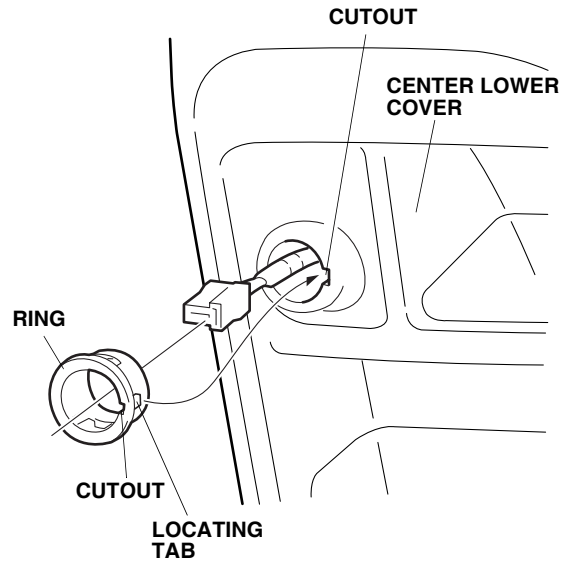

- Push the vehicle 2-pin connector into the socket.

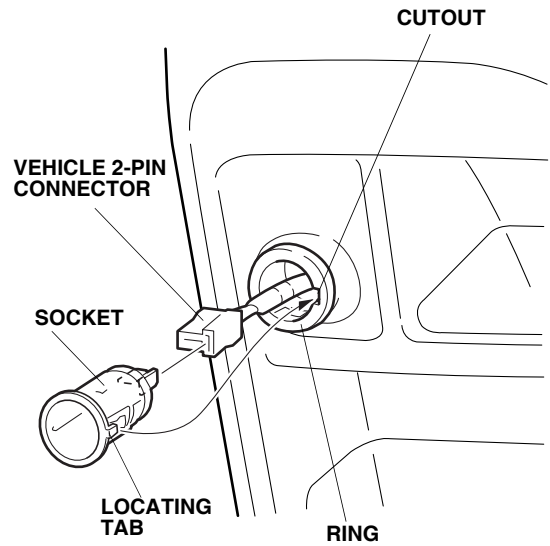

- Align the locating tab on the socket with the cutout in the ring, and slide the socket into the ring.

10. Push the cigarette lighter into the socket.

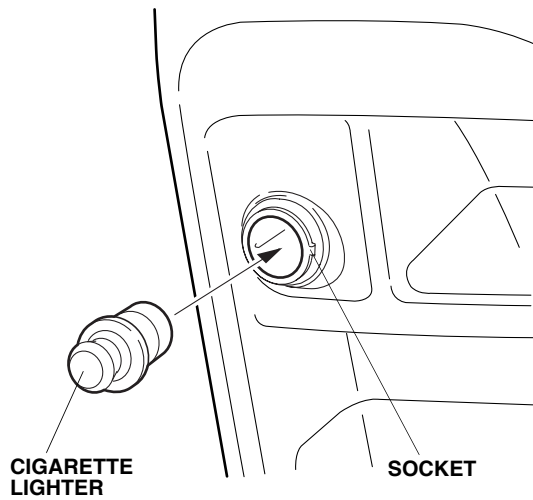

11. Attach the 15A fuse label to the No. 29 slot on the driver's seat side undercover.

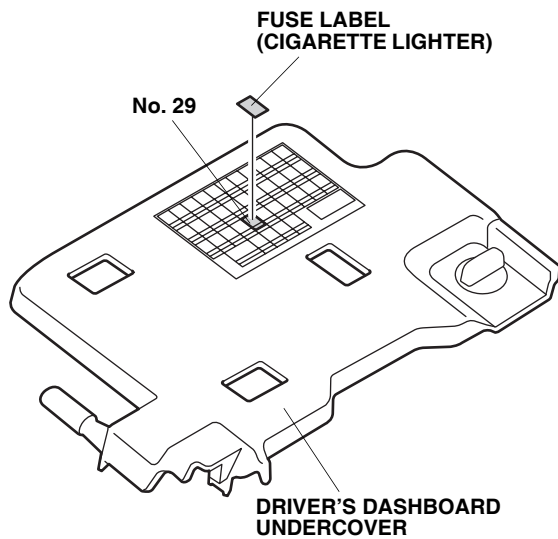

12. Reinstall the all removed parts.
13. Reconnect the negative cable to the battery.
14. Enter the customer's radio anti-theft code, and reset the radio station presets.
15. Reset the clock.
16. Test the cigarette lighter.