



INSTALLATION INSTRUCTIONS

Accessory

**MP3 PLAYER
ATTACHMENT KIT**

Application

2007 RIDGELINE

Publications No.

All 32434

Issue Date

MAY 2006

PARTS LIST

**Attachment Kit:
P/N 08B06-SJC-100**

Right player bracket

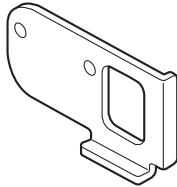

Left player bracket

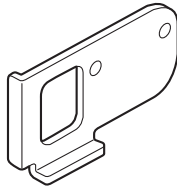

Player panel

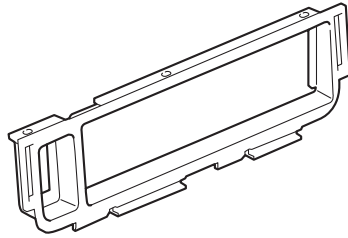

BUS cable



Harness clip

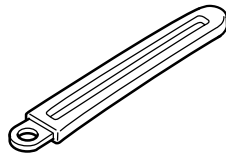

Washer-screw, 4 x 8 mm



**MP3 Player Kit (sold separately):
P/N 08A06-4E1-200**

MP3 player

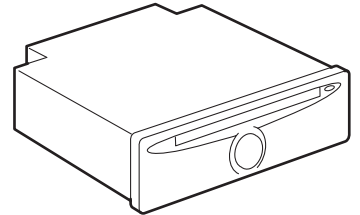

4 Washer-bolts, 5 x 8 mm

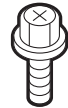

Owner's Manual

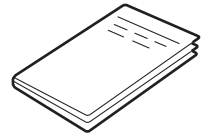

TOOL AND SUPPLIES REQUIRED

Phillips screwdriver
Flat-tip screwdriver
Shop towel

INSTALLATION

Customer Information: The information in this installation instruction is intended for use only by skilled technicians who have the proper tools, equipment, and training to correctly and safely add equipment to your vehicle. These procedures should not be attempted by "do-it-yourselfers."

1. Make sure you have the anti-theft code for the radio, then write down the radio station presets.
2. Disconnect the negative cable from the battery.
3. Insert a flat-tip screwdriver, wrapped with a shop towel, into the groove of the meter panel to release the two clips. Pull the meter panel out toward you to release the 18 clips, and then remove the meter panel by unplugging the vehicle connectors.

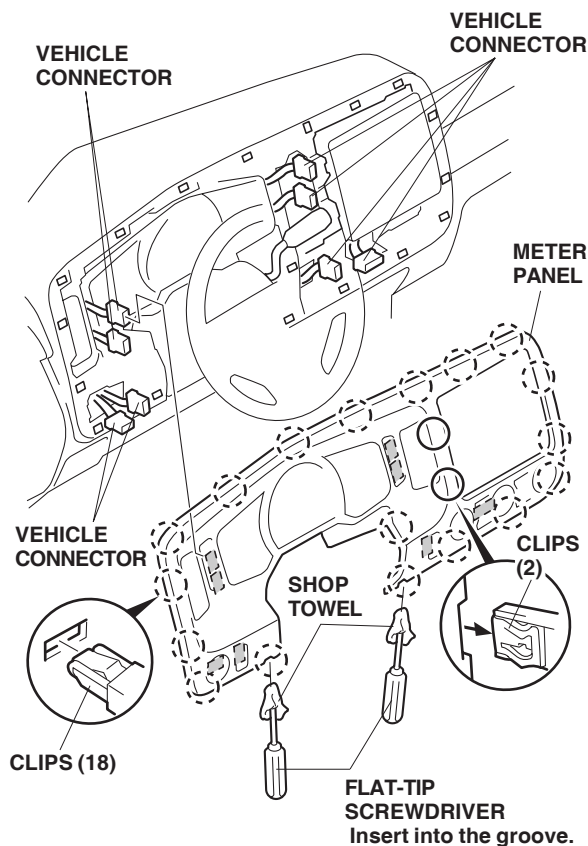

4. Remove the audio unit (five bolts, pull the audio unit out toward you, and unplug the vehicle connectors).

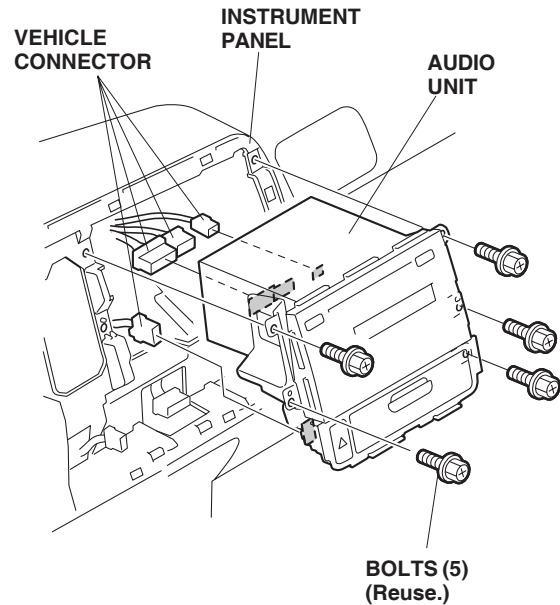

5. Remove the left and right vehicle brackets, and the pocket from the audio unit by removing the eight bolts and two self-tapping screws.

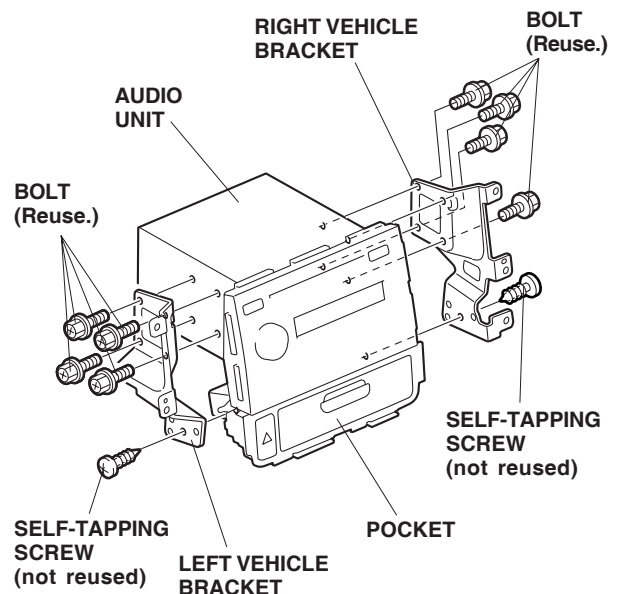

- Remove the hazard switch from the pocket (two retaining tabs).

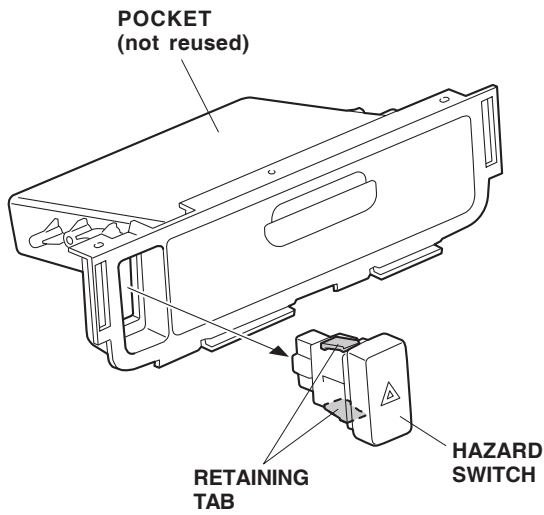

- Insert the player into the new player panel.

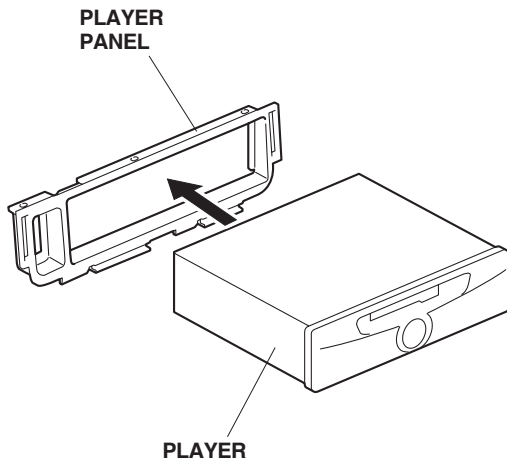

- Reinstall the vehicle brackets to the audio unit with the eight bolts removed in step 5.

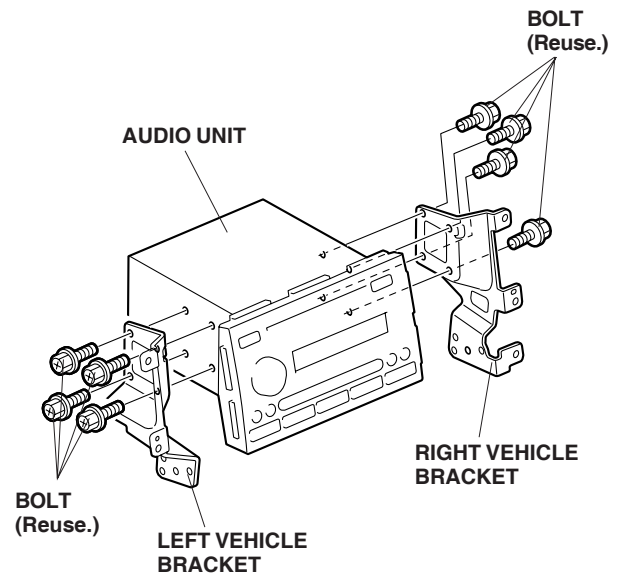

- Insert the pins on the audio unit into the holes in the player panel, and attach the audio unit to the player. Position the left and right player brackets on the vehicle brackets, and install the four 5 x 8 mm washer-bolts included with the player kit.

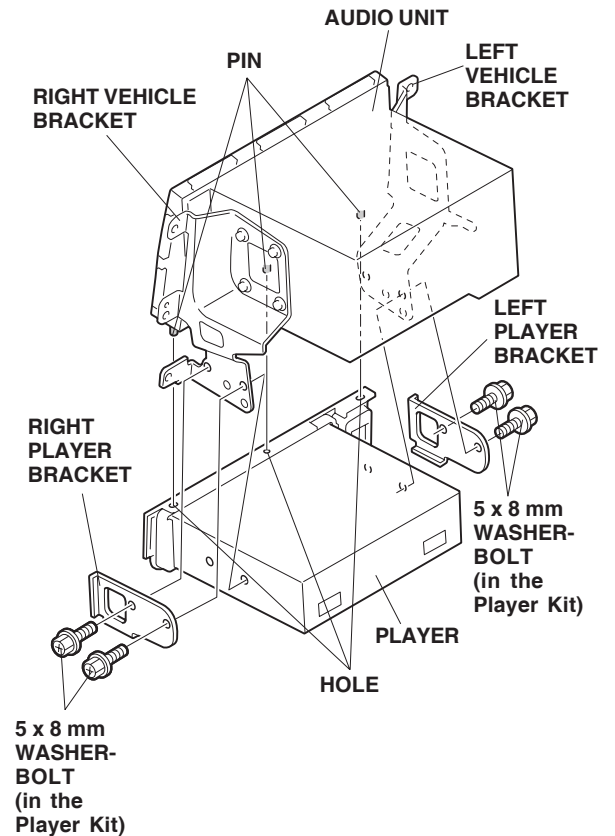

10. Install the hazard switch (removed in step 6) into the player panel.

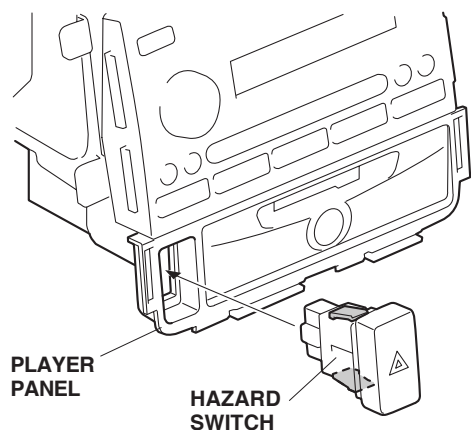

11. Plug the BUS cable 14-pin connector into the audio unit and into the player. Install the harness clip to the rear of the player with the 4 x 8 mm washer-screw.

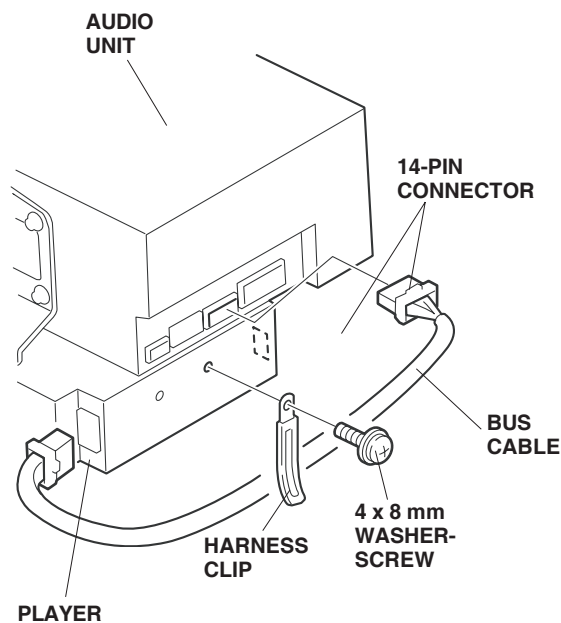

12. Secure the BUS cable with the harness clip.

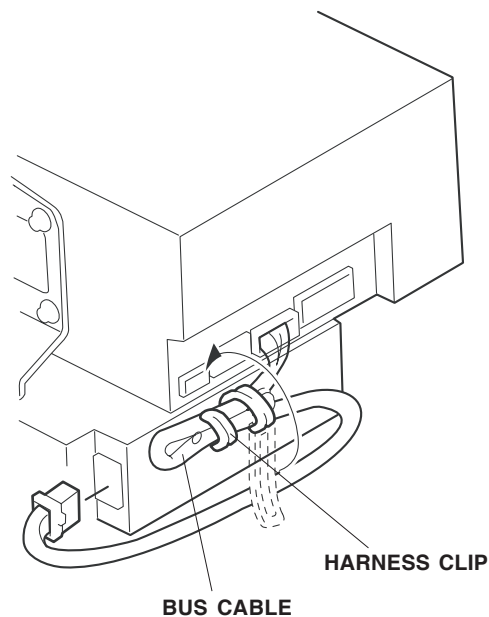

13. Plug the vehicle connectors into the audio unit, and into the player.

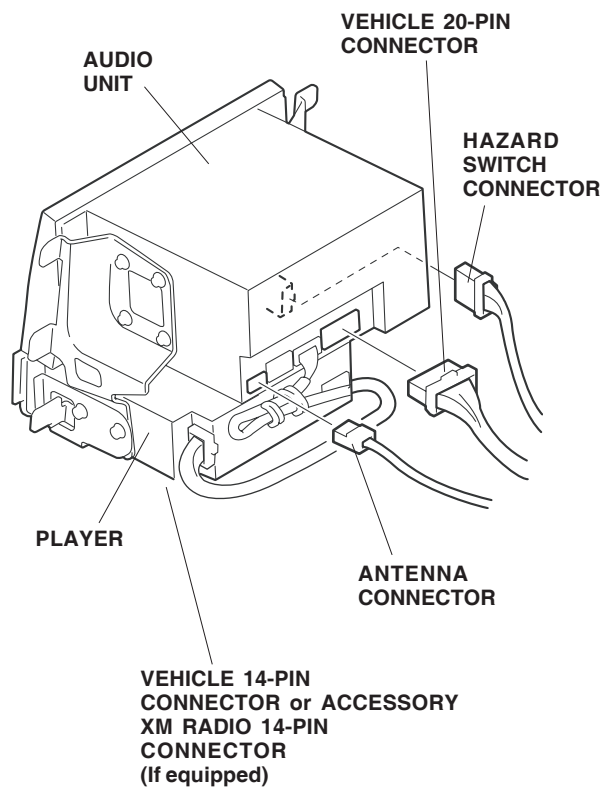

14. Reinstall the audio unit/player assembly.

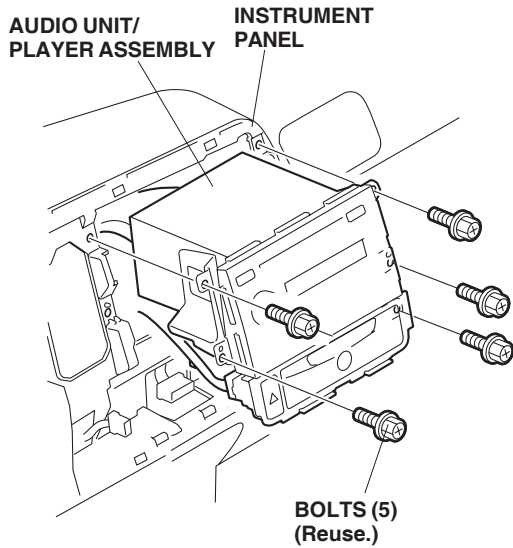

15. Check that all wire harnesses are routed properly and all connectors are plugged in.
16. Reconnect the negative cable to the battery.
17. Enter the customer's radio anti-theft code, and reset the radio station presets.
18. Set the clock.
19. Check the operation of the player according to the owner's manual.
20. Put the player owner's manual in the glove box.
21. Reinstall all removed parts.

NOTE: Whenever the battery is disconnected, the driver's window AUTO function is disabled.

22. Start the engine. Push down on the driver's window switch until the window is fully open.
23. Pull up on the driver's window switch fully to close the window completely, then hold the switch for 2 seconds or more.
24. Check the window AUTO function by opening and closing the window with the driver's window switch.