



INSTALLATION INSTRUCTIONS

Accessory

DOOR EDGE GUARDS

Application

2007 CIVIC
2-DOOR

Publications No.

All 33531

Issue Date

AUG 2006

PARTS LIST

Left door edge guard

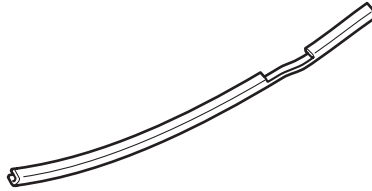

Right door edge guard

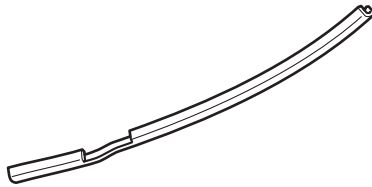

Hem sealant cutting tool

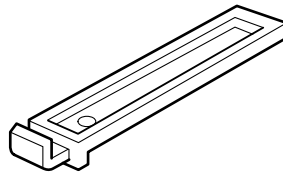

TOOLS REQUIRED

Rubber mallet

Felt-tip pen

Touch-up paint

Tape measure

INSTALLATION

Customer Information: The information in this installation instruction is intended for use only by skilled technicians who have the proper tools, equipment, and training to correctly and safely add equipment to your vehicle. These procedures should not be attempted by "do-it-yourselfers."

NOTE: These instructions show the right door edge guard being installed. The same procedure applies to installing the left door edge guard.

1. Clean and wax the areas to be covered with a high-quality paste wax.
2. Identify each door edge guard by holding it up to the door and matching its contour with the door edge.

Installing the Door Edge Guards

- Using a tape measure and a felt-tip pen, measure and mark the inside edge of the right front door at the measurements shown.

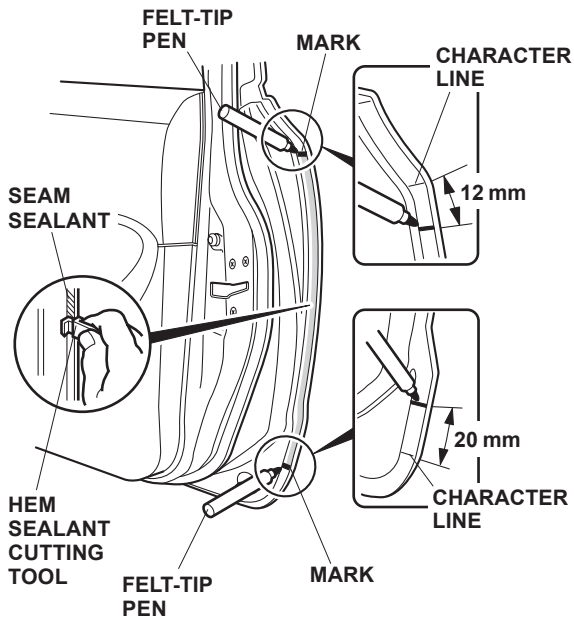

- Position the hem sealant cutting tool against the door edge, and trim the seam sealant from mark to mark.

NOTE: The cutting tool only cuts in one direction. Move it upward on the right door, and downward on the left door.

- Apply touch-up paint to the door, and let it dry.

- Position the right door edge guard on the door edge, and tap it into position with a series of light taps using a rubber mallet.

NOTE: Once in place, do not remove, reposition, or reinstall the door edge guard, otherwise it will not hold securely.

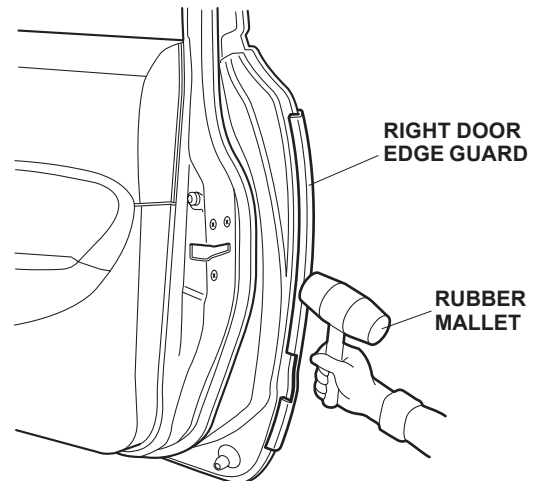
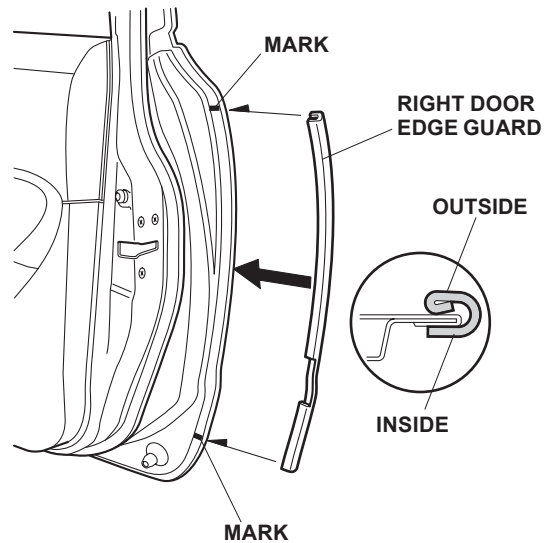

- Repeat steps 3 through 6 to install the left door edge guard on the left front door.