



INSTALLATION INSTRUCTIONS

Accessory

**SNOWBOARD ATTACHMENT
P/N 08L03-SCV-100**

Application

2006 CR-V

Publications No.

All 30534

Issue Date

SEP 2005

Put this information in the glove box with the vehicle owner's manual.

PARTS LIST

2 Snowboard carriers

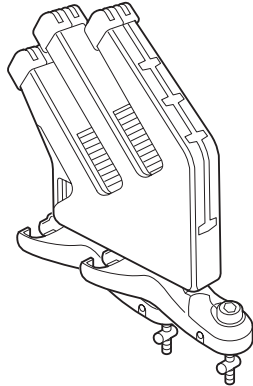

4 Bottom clamps



16 Rubber blocks



4 Torx screws



4 Board supports



2 Keys



Torx wrench

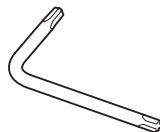

2 Locking cables



2 Board protectors

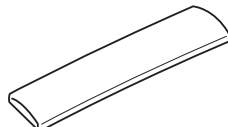

INSTALLATION

NOTE: Be careful not to damage the body paint finish.

1. Rotate the two top clamps of the snowboard carrier so they are perpendicular to the snowboard carrier.

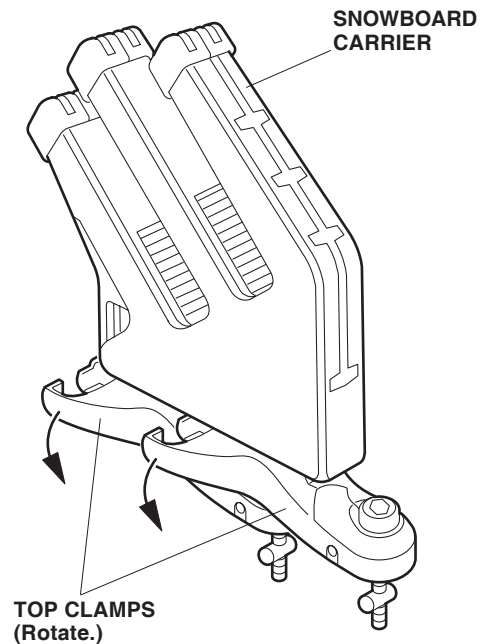

2. Install two board supports on the snowboard carrier.

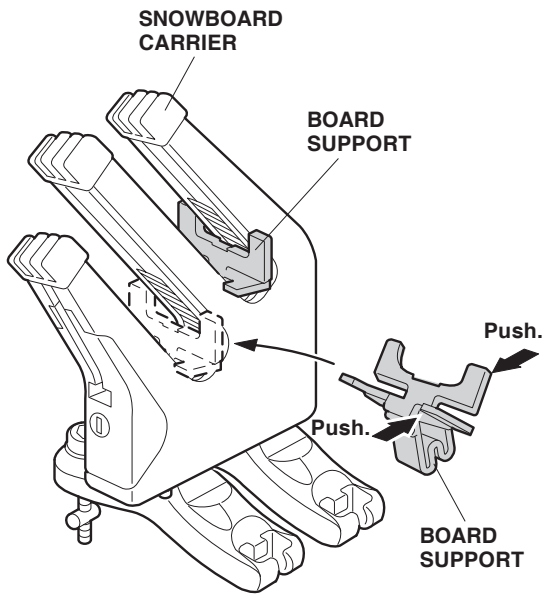

3. Install four rubber blocks on the top and bottom clamps. Install the rubber blocks with the apex of each triangular mark "△" facing the inside.

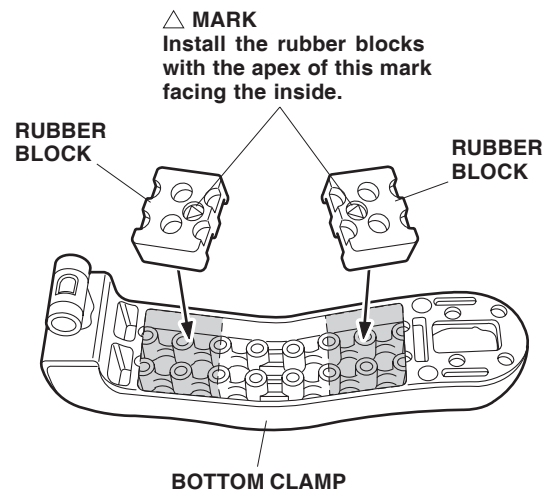
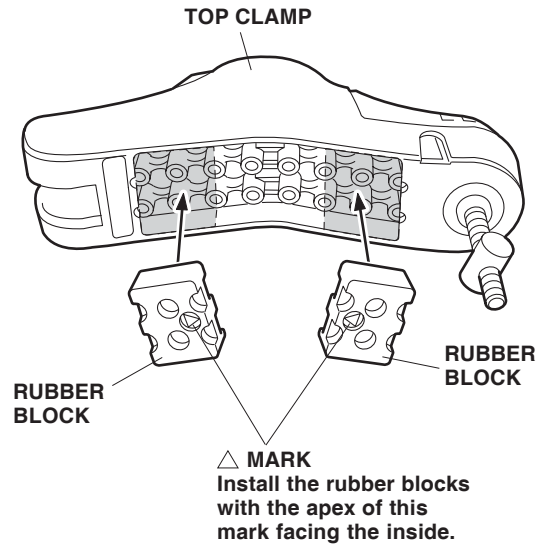

- Turn the cam levers on the top clamp counterclockwise.

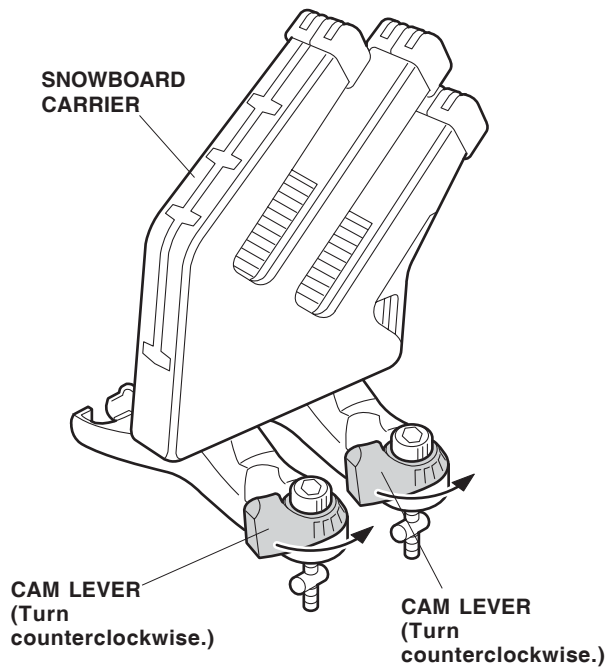

- Attach the two bottom clamps to the two top clamps.

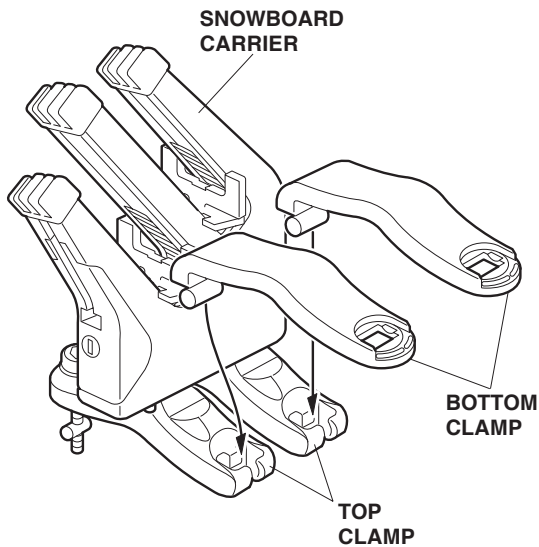

- Repeat steps 1 thru 5 to assemble the other carrier.

- Attach one carrier to the front cross bar in the direction shown. Insert the barrel nuts on the top clamp into the square holes in the bottom clamp, and turn the nuts 90° to lock them into position. Install the other carrier to the rear cross bar using the same procedure. Make sure the rear cross bar is parallel to the front cross bar.

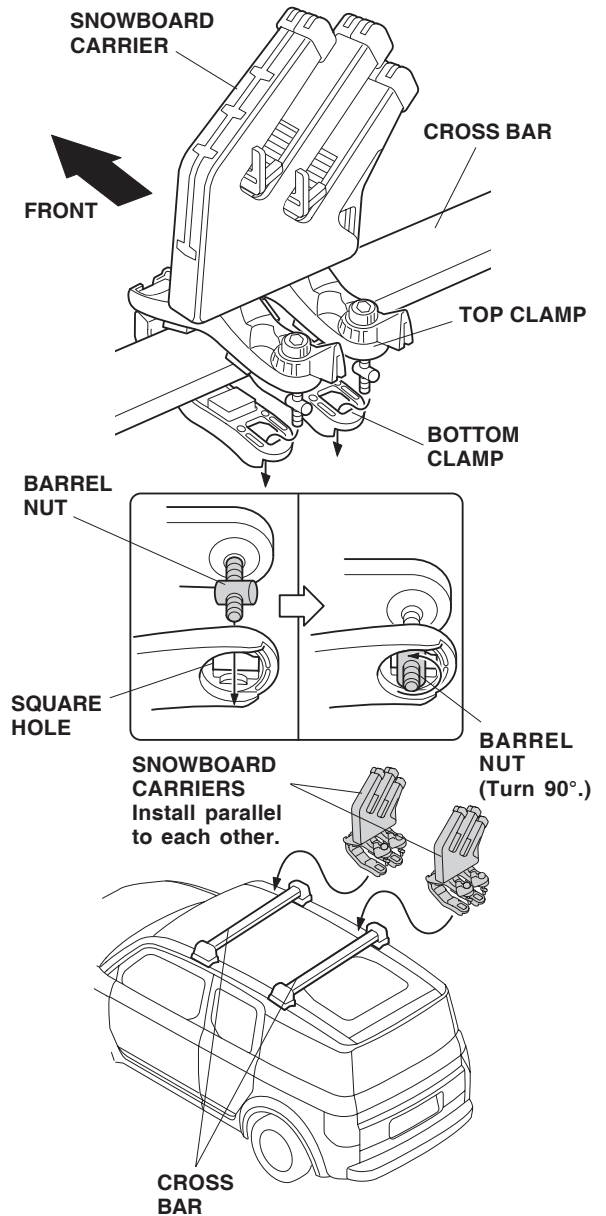

8. Turn the knobs on the top clamp to tighten the front carrier.

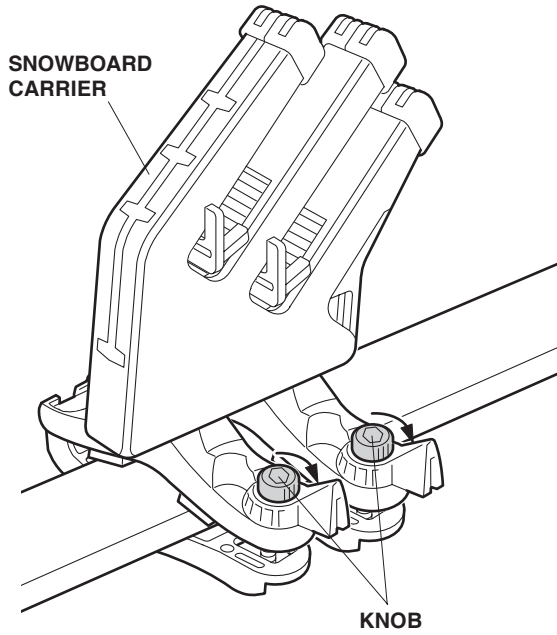

9. Return the cam levers to the original location (turn clockwise).

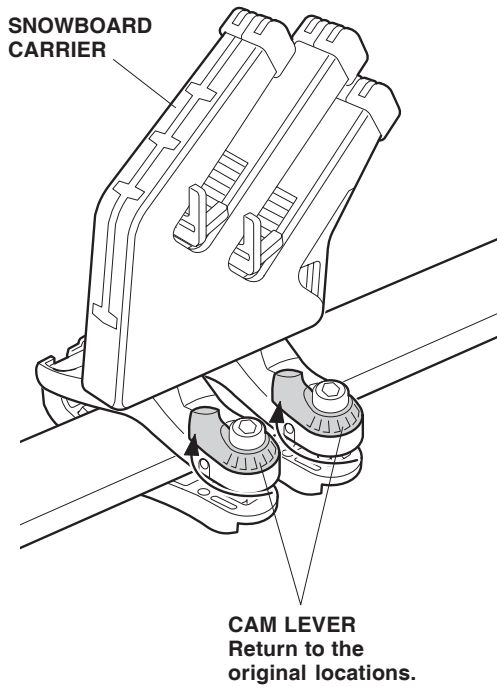

10. To prevent theft, install the screws in the holes in the top clamps.

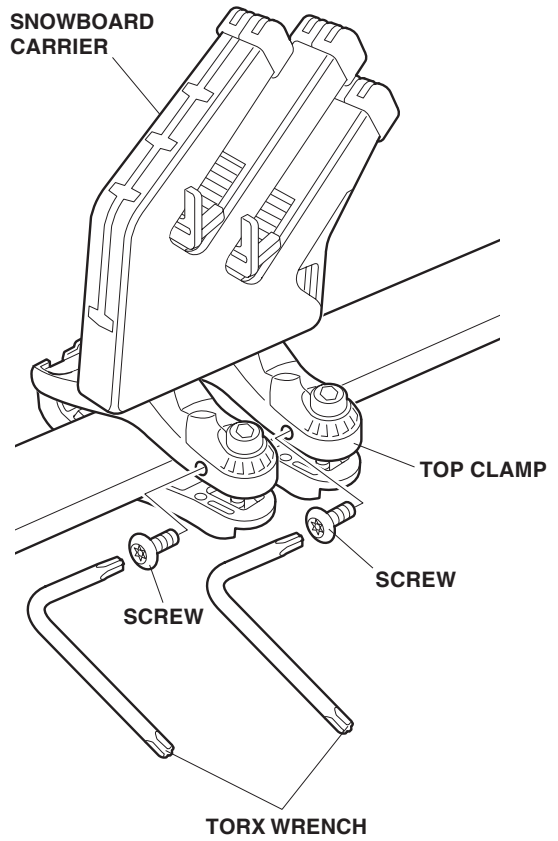

11. Repeat steps 8 thru 10 to tighten the other carrier.
12. Rock the carriers in all directions to make sure they are securely installed.

13. Thread the locking cable through the board protector.

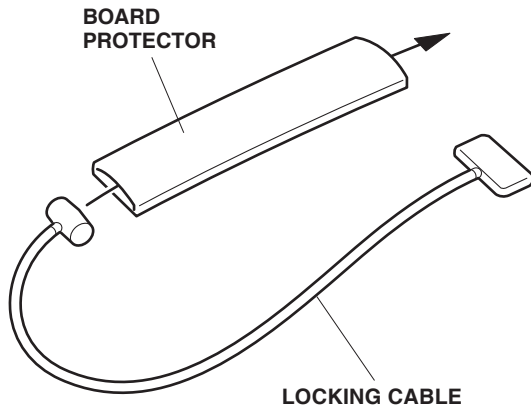

14. Insert the locking cable plate into the slot of the snowboard carrier. To carry one snowboard, insert the plate into the lowest slot. To carry two snowboards, use one of the three upper slots in the carrier.

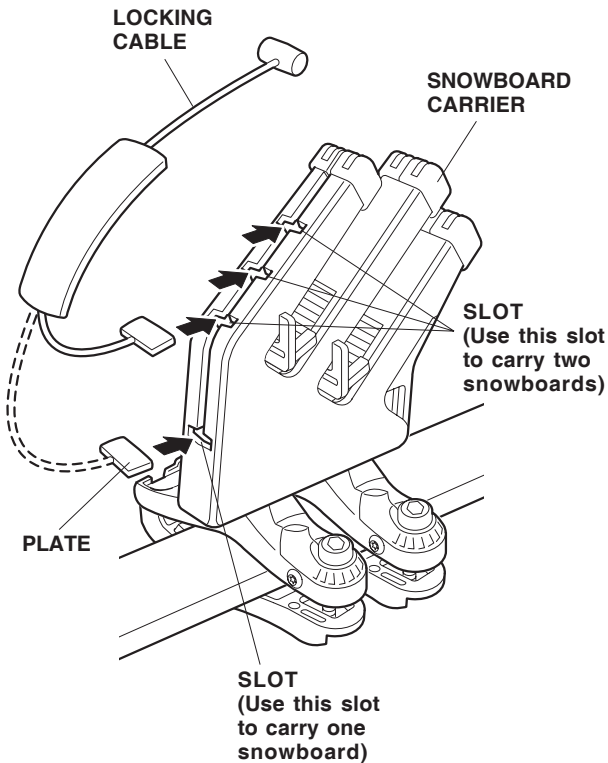

15. After loading each snowboard on the carrier, adjust it with the help of the board supports so that the top edges are level and the boards are as far down in the carrier as possible. To secure the snowboard use the key to open the covers, then insert the locking cable stoppers into the holes of the carrier covers.

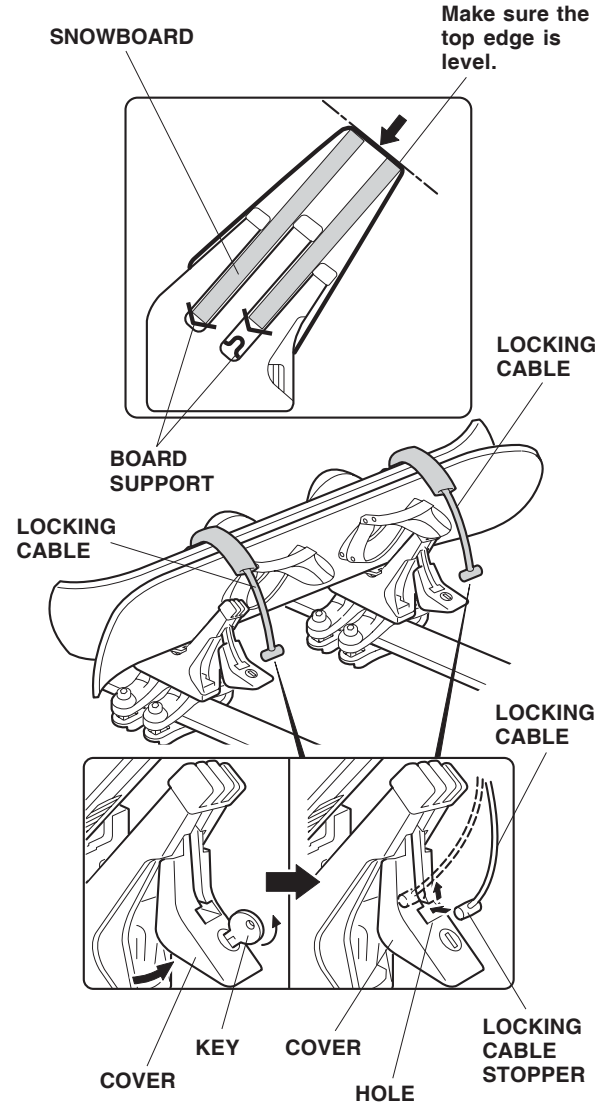

16. Check that the locking cables are installed securely, then close the covers.

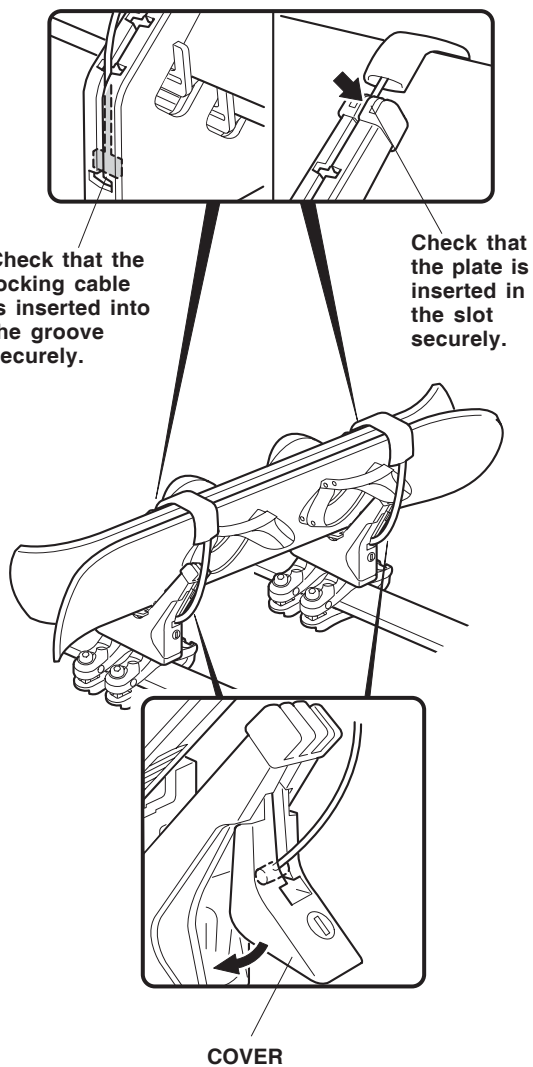

17. The cover must be locked during transportation.

