



INSTALLATION INSTRUCTIONS

Accessory

BIKE ATTACHMENT
P/N 08L07-TA1-102

Application

2006 CR-V

Publications No.

All 30537

Issue Date

SEP 2005

PARTS LIST

Bike attachment

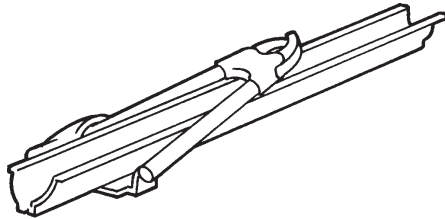

2 Wheel straps

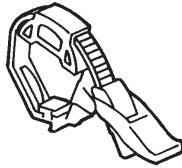

2 End caps



2 Keys



Instruction sheet
(with Allen wrench)

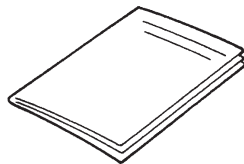

TOOLS REQUIRED

Flat-tip screwdriver

INSTALLATION

NOTE:

- Be careful not to damage the painted surfaces of the vehicle when installing the bike attachment.
- If you are installing more than one bike attachment, you may need to alternate the mounting positions (front to rear) to allow for handle bar clearance.
- Make sure the security retainer, and the locking clamp lever are installed on the outboard side, see the instruction sheet for details.

Preparing the Bike Attachment

1. Slide a wheel strap onto one end of the bike attachment channel. Repeat on the other end. Make sure both wheel strap buckles are on the same side.

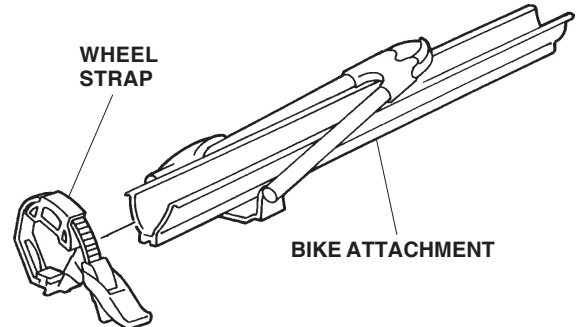

2. Install an end cap on the bike attachment channel by aligning the locktabs on the end cap, with the holes in the channel. Push down on the end cap until the locktabs "click" into place. Repeat on the other end.

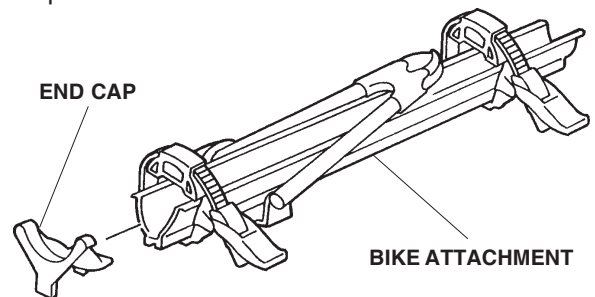

3. Turn and loosen the mounting levers on the bike attachment.

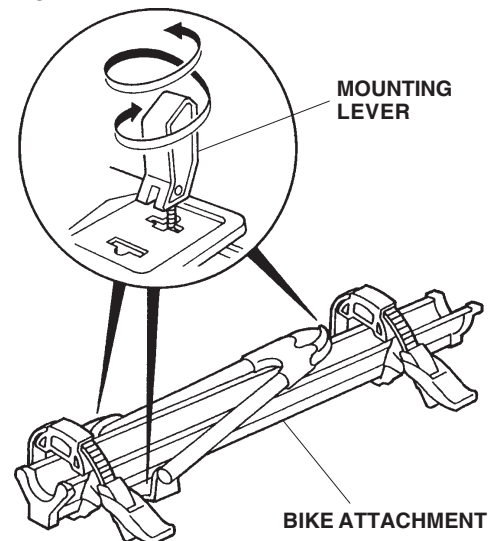

Installing the Bike Attachment

- Using a flat-tip screwdriver, gently pry up to remove the roof rack cover. Remove the roof rack cover from the other roof rack on the same side of the vehicle.

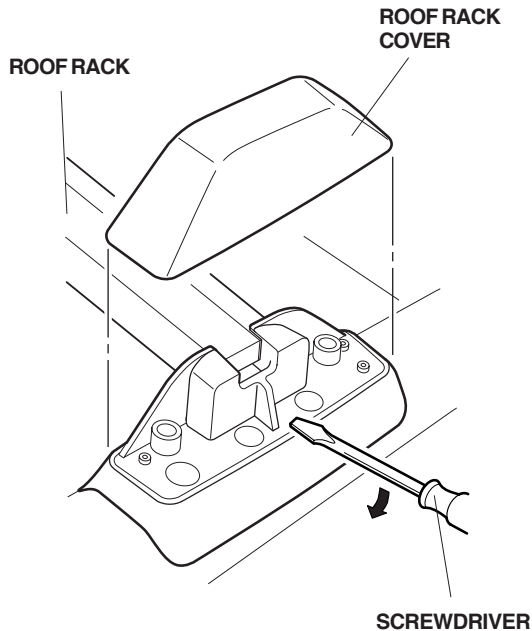

- Remove the rubber moldings from the front and rear roof rack crossbars. Retain the rubber moldings to be reinstalled later.

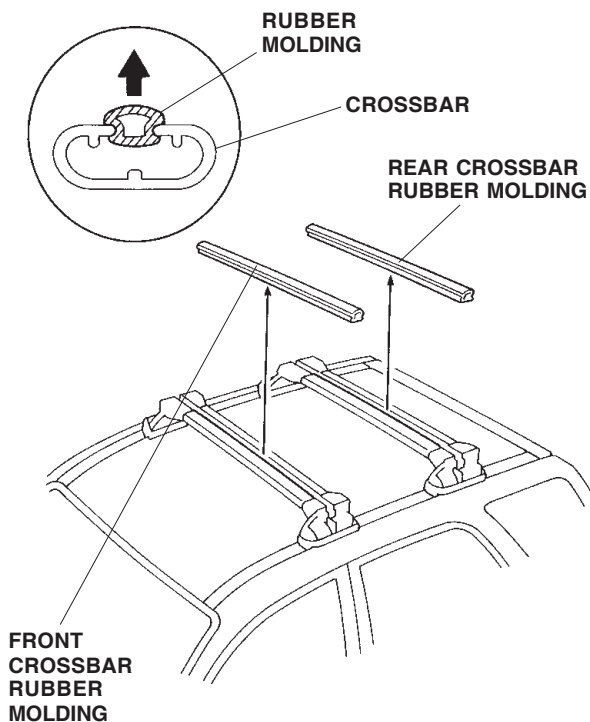

- Insert the T-bolts of the bike attachment into the channel of the crossbar (two T-bolts for the front of the bike attachment, and one T-bolt for the rear), and position the bike attachment on the front and rear crossbars.

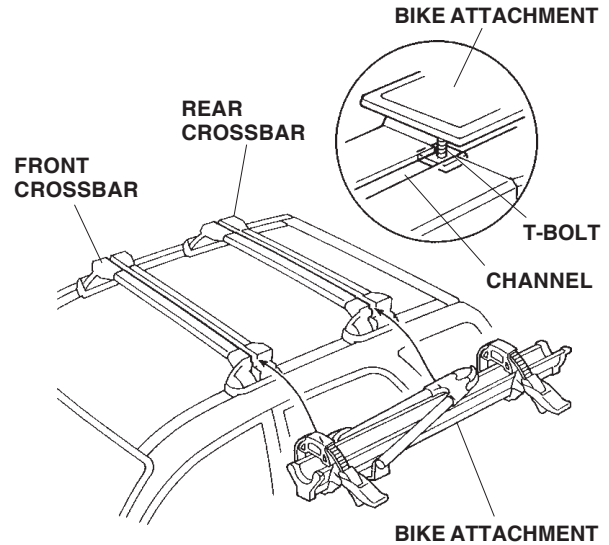

- Turn and adjust the mounting lever to lock the bike attachment to the roof rack. Check for firm pressure while you push down on the mounting lever to lock it into place.

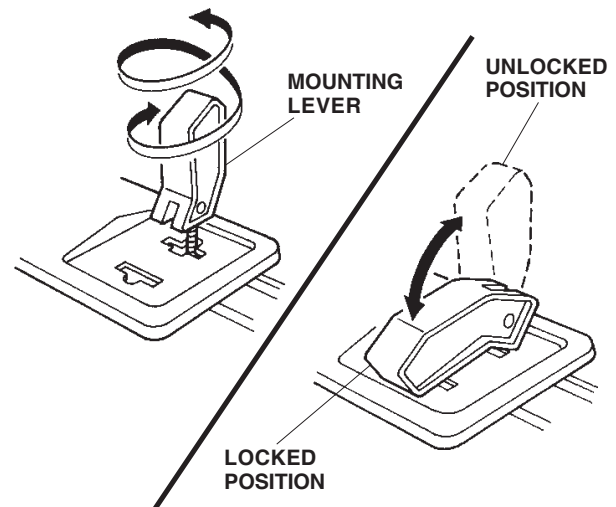

- If the mounting lever pressure is too tight (the lever will not lock into place), lift up on the lever and turn it counterclockwise.
- If the mounting lever pressure is too loose (the lever locks into place, but the bike attachment is loose on the crossbars), lift up on the lever and turn it clockwise.

- Slide the security retainer in place; then close the locking clamp lever. To deter theft of the bike attachment, lock the locking clamp lever with the key.

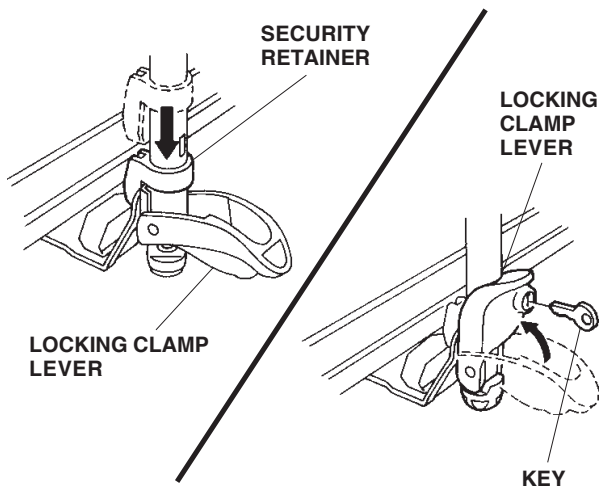

- Reinstall the roof rack covers on the roof rack.

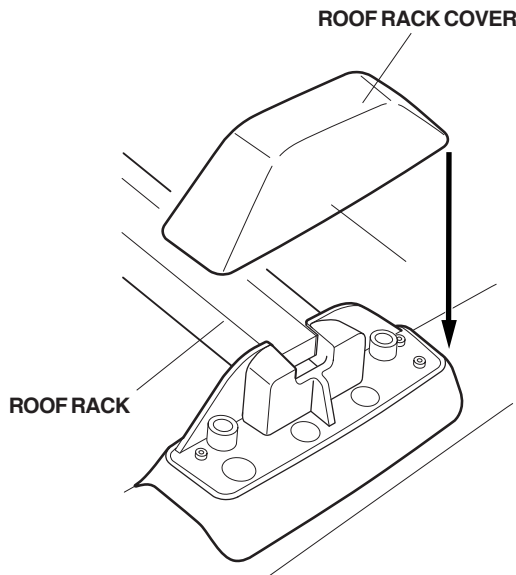

- Put these instructions and the Bicycle Installation Instruction sheet in the glove box.
- Put the keys in the glove box.
- Put the rubber moldings removed in step 5 in a plastic bag, and put the bag in the vehicle for the customer. (The rubber moldings can also be cut and reinstalled into the grooves in the roof rack.)
- Advise the customer that reinstalling the rubber moldings will help reduce wind noise if the bike attachment is removed.